



ИБП Eaton PW 9315-100 - Руководство по установке Powerware 9315 30kVA - 160kVA UPS

Постоянная ссылка на страницу: <https://eaton-power.ru/catalog/powerware-9315/pw-9315-100/>



POWERWARE[®] 9315

*30 kVA-160kVA
Uninterruptible Power
Supply*

Operation Manual

164200252 Rev. I

IMPORTANT SAFETY INSTRUCTIONS

Instructions Importantes Concernant La Sécurité

SAVE THESE INSTRUCTIONS

Conserver Ces Instructions

This manual contains important instructions for your Uninterruptible Power Supply (UPS) system. You should follow these instructions during the installation and maintenance of the UPS, options, accessories, and batteries.

Cette notice contient des instructions importantes concernant la sécurité.

This equipment has been tested and found to comply with the limits for a Class A digital device, pursuant to Part 15 of the FCC Rules. These limits are designed to provide reasonable protection against harmful interference when the equipment is operated in a commercial environment. This equipment generates, uses, and can radiate radio frequency energy and, if not installed and used in accordance with the instruction manual, may cause harmful interference to radio communications. Operation of this equipment in a residential area is likely to cause harmful interference in which case the user will be required to correct the interference at their own expense.

WARNING:

This is a product for restricted sales distribution to informed partners. Installation restrictions or additional measures may be needed to prevent disturbances.

Table of Contents

1 Introduction	1
Using This Manual	1
For More Information	2
Getting Help	2
2 Getting Started	3
Looking Inside the UPS	4
UPS Standard Features	5
Monitor Panel	5
Control Panel	5
Communication Panel	5
Computer Interface	5
Summary Alarm Contacts	5
Building Alarm Monitoring	5
Input Filter	5
Emergency Load Off	5
Automatic Battery Charge Current Limit	5
Installation Features	6
Options and Accessories	6
Battery	6
External Battery Disconnect	6
Power Distribution Module (available for North American voltages only)	6
Upgrade Capability	6
Remote Monitor Panel	6
Relay Interface Module	6
Isolation Transformer	6
Modem	7
Customer Convenience Outlet	7
Safety Considerations	7
Symbols, Controls, and Indicators	8
3 Understanding UPS Operation	9
Normal Mode	10
Bypass Mode	11
Battery Mode	12
Monitoring and Controlling UPS Operation	13

4 Starting and Stopping the UPS	15
Using the Control Panel	15
To Place the UPS in Normal Mode	16
To Shut Down the UPS from Normal Mode	17
To Start the UPS in Bypass Mode	17
To Shut Down Power to the Critical Load While in Bypass Mode	17
5 Using the Monitor Panel	19
Using the LCD Screen	20
Using the Pushbuttons	21
Adjusting the Contrast	21
Using the Load Off Pushbutton	21
Reading the Status Indicators	22
Using the Menu Options	23
6 Using Features and Options	31
Building Alarm Monitoring	31
Summary Alarm Contacts	32
Remote Monitor Panel	33
Battery Cabinets	35
External Battery Disconnect	35
Relay Interface Module	36
Supervisory Contact Module	37
7 Serial Communications	39
Locating the Communications Panel	40
Connecting Equipment to a Serial Port	41
Configuring the Serial Ports	43
Mode	44
Rate	44
Data/Stop	45
Handshaking	45
Disabled (No Handshaking)	45
XON/XOFF	45
Save	45
Default Settings	45
Terminal Mode	46
Printing Selected Information	46
Entire Log (Ctrl + P)	47
Meters Printout (Ctrl + M)	48
System Information Printout (Ctrl + A)	48
Battery Test Printout (Ctrl + B)	49

System Configuration	50
System Configuration Mode Main Menu	50
Program Building Alarms	50
Enable/Disable Default Functions	51
Customize Alarm Messages	52
Program Unit Name	52
Adjust Output Voltage	53
Change Password	53
Battery Test Setup	54
Modify Low Battery Time	55
Calibration Mode	55
Computer Mode	55
Remote Monitor Mode	55
8 Remote Notification	57
Remote Notification Features	58
Description of Operation	59
Call Answer	59
Call Out	59
Housekeeping	60
Hardware Requirements	61
Configuring the Modem	62
Basic Modem Configuration	62
Configuring the Modem to Call a Remote Computer	63
Configuring the Modem to Call a Numeric Pager	64
Configuring the Modem to Answer Incoming Calls	65
Final Modem Configuration	66
UPS Setup Configuration	67
User-Selected Events	68
9 Maintaining the UPS System	71
Important Safety Instructions	71
Performing Preventive Maintenance	73
Maintenance Training	73
10 Product Specifications	75
System Input	75
System Output	76
Environmental Specifications	77
Battery Specifications	77

11 Responding to System Events	79
System Event Horns	79
System Event Lights	79
System Event Messages	80
12 Using the LOAD OFF Pushbutton	83
To use the LOAD OFF Pushbutton	83
Resetting the UPS System after Load Off	83

List of Figures

Figure 1.	Typical Powerware Plus UPS System	3
Figure 2.	Main Elements of the UPS System	4
Figure 3.	Path of Current Through the UPS in Normal Mode	10
Figure 4.	Path of Current Through the UPS in Bypass Mode	11
Figure 5.	Path of Current Through the UPS in Battery Mode	12
Figure 6.	Location of the Monitor Panel and the Control Panel	13
Figure 7.	UPS Control Panel	15
Figure 8.	UPS Monitor Panel	19
Figure 9.	Parts of the LCD Screen (Typical for Powerware Plus 80 480/208V Unit)	20
Figure 10.	System Meters Screen (Typical for Powerware Plus 80 480/208V Unit)	23
Figure 11.	Load Amps Meters Screen	24
Figure 12.	Event History Log Screen	25
Figure 13.	Active System Events Screen	26
Figure 14.	Unit Statistics Screen	27
Figure 15.	Mimic Screen	28
Figure 16.	Time Setup Screen	29
Figure 17.	Port Setup Screen	30
Figure 18.	External Connections for Building Alarm Monitoring	31
Figure 19.	Summary Alarm Contacts	32
Figure 20.	Remote Monitor Panel	33
Figure 21.	Relay Interface Module	36
Figure 22.	Supervisory Contact Module	37
Figure 23.	Location of Communications Ports on the UPS (Powerware Plus 80)	40
Figure 24.	Port 1 Pin Assignments	41
Figure 25.	Port 2 Pin Assignments	42
Figure 26.	Setup Serial Port 1 Screen	43
Figure 27.	Event History Log	47
Figure 28.	System Meters	48
Figure 29.	Battery Test Log	49

This Page Intentionally Left Blank.

1

Introduction

Congratulations on your purchase of a Powerware® 9315 Uninterruptible Power Supply! The Powerware 9315 online power protection can be utilized to prevent loss of valuable electronic information, minimize equipment downtime, and/or minimize the adverse effect on equipment production due to unexpected power problems.

The Powerware 9315 Uninterruptible Power Supply (UPS) continually monitors incoming electrical power and removes the surges, spikes, sags, and other irregularities that are inherent in commercial utility power. Working with your building's electrical system, the UPS supplies clean, consistent power that your sensitive electronic equipment requires for reliable operation. And during brownouts, blackouts, and other power interruptions, one or more optional battery cabinets can provide emergency power to safeguard your operation.

Your UPS will function automatically and require very little attention during normal operation. However, you should read and understand the procedures described in this manual to ensure trouble-free operation. In particular, you should be thoroughly familiar with the Load Off procedure described in Chapter 12.

Using This Manual

This manual describes the Powerware 9315 UPS routine operation and maintenance. It also describes optional features and accessories that are available to enhance UPS operation and performance. The text uses these conventions:

- **Bold type** highlights important concepts in discussions, key terms in procedures, and menu options.
- *Italic type* highlights notes and new terms where they are defined.
- Rectangular boxes containing bold type are warnings or cautions that pertain to the UPS system or its electrical connections. This important information alerts you to possible dangers pertaining to personnel safety, UPS or equipment damage, critical load protection, or operational concerns.

In this manual, the term *UPS* refers only to the UPS cabinet and its internal elements. The term *UPS system* refers to the entire power protection system—the UPS cabinet and any options or accessories you have installed. The rectifier and inverter are internal UPS components that are together referred to as the *power processing unit (PPU)* of the UPS.

For More Information

This manual describes how your UPS system works. For more information about your system, refer to the following:

164200253 *Powerware® 9315 30–80 kVA UPS Installation*

164200292 *Powerware® 9315 100–160 kVA UPS Installation*

Both manuals contain the following information:

- How to prepare your site and plan for installation
- Detailed step-by-step procedures for installing each component of your system
- How to join cabinets in a line-up-and-match system
- Detailed illustrations of cabinets and optional accessories, including dimensions and connection points.

Contact Powerware Corporation Field Service for information on how to obtain copies of these manuals.

Getting Help

If you have a question about any of the information in this manual, or if you have a question this manual does not answer, please call Powerware Corporation Field Service:

United States 1-800-843-9433

Canada 1-800-461-9166

Outside the U.S. Call your local representative

2

Getting Started

Each component of the UPS system is housed in a free-standing *cabinet* designed for industrial or computer room applications. The cabinets line up and match in style and color, and have *safety shields* behind the doors for hazardous voltage protection. Figure 1 shows a typical Powerware 9315 UPS system.

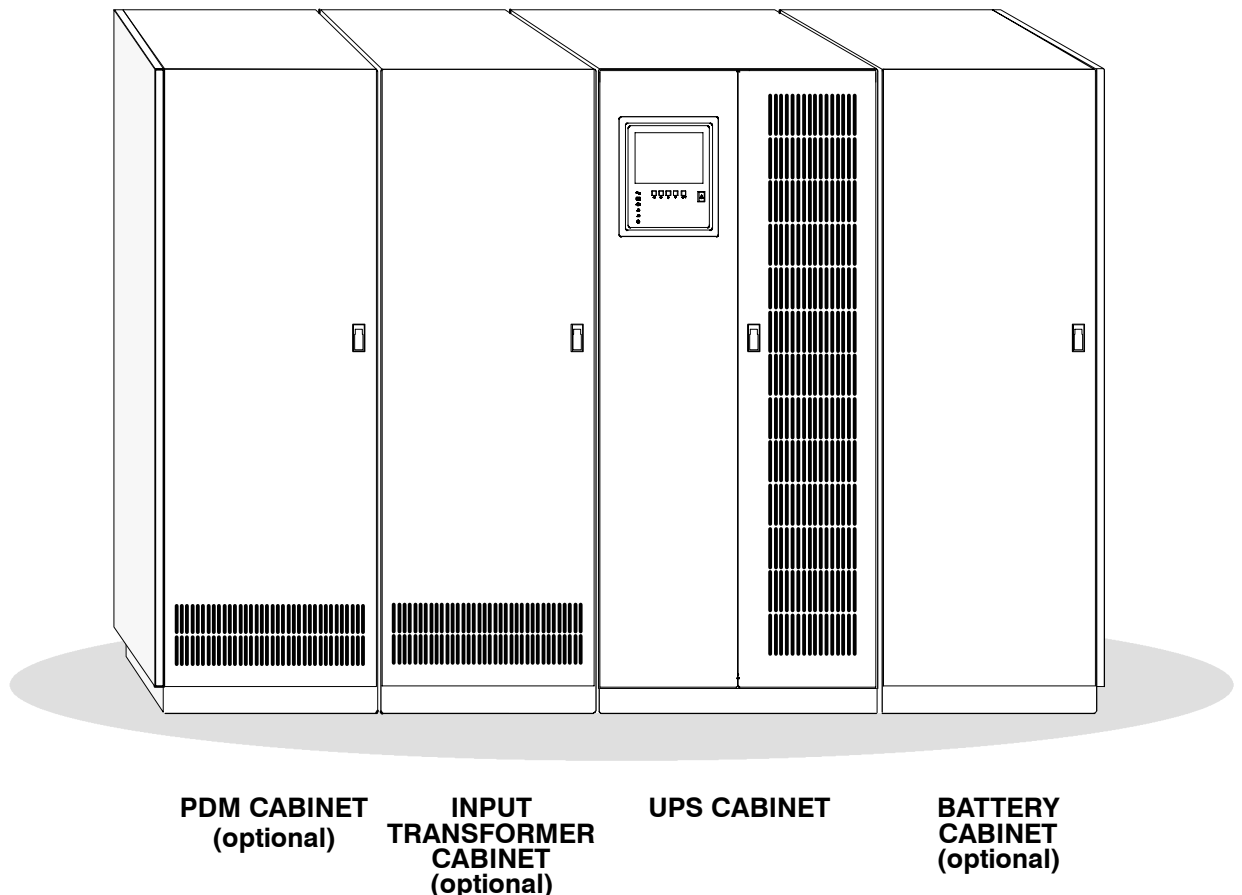

Figure 1. Typical Powerware 9315 UPS System

Each cabinet of the UPS system is shipped separately with hardware for joining to other cabinets during installation. As shown in Figure 1, you can combine a UPS with any of the options described in this manual to meet your system needs. The UPS and options are described in detail later in this manual. The following descriptions provide a brief overview of standard UPS features and available enhancements.

NOTE: You should read this manual and have thorough knowledge of UPS operation before attempting to operate any of the switches or controls on the UPS or optional components.

Looking Inside the UPS

The Powerware 9315 is a continuous duty, solid-state UPS that supports the following equipment: process control, data processing, telecommunications/PBX, research, and medical. The Powerware 9315 maintains power to the critical loads during commercial electrical power brownout, blackout, overvoltage, undervoltage, and out-of-tolerance frequency conditions.

In this manual, the power required by your equipment is called the *critical load*. The UPS supplies the critical load with conditioned power that is synchronized with your utility power. Figure 2 shows the main elements of the UPS.

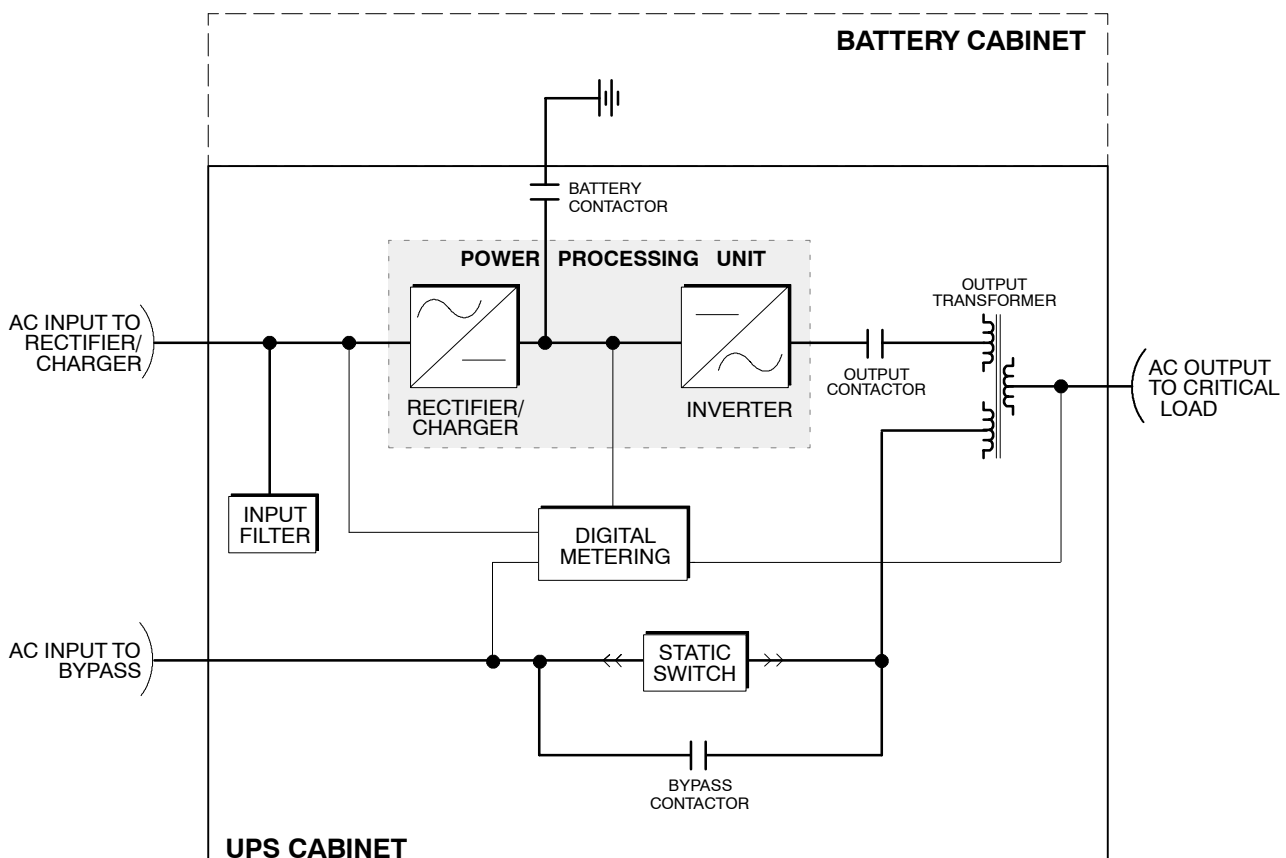

Figure 2. Main Elements of the UPS System

If utility power is interrupted or falls outside the parameters specified in Chapter 10, "Product Specifications," the UPS uses a *backup battery supply* to sustain power to the critical load for a specified period of time or until the utility power returns. For extended power outages, the backup battery supply allows you to either transfer to an alternative power system (such as a generator) or shut down your critical load in an orderly manner.

The operation of the UPS system is described in greater detail in Chapter 3, "Understanding UPS Operation." Chapter 10, "Product Specifications," outlines the storage and operating specifications for the UPS and optional battery.

UPS Standard Features

The UPS has many standard features that provide cost-effective and consistently reliable power protection:

Monitor Panel

The *Monitor Panel* on the front of the UPS contains an LCD screen to display the current status of the UPS. You can view a statistical history and log of UPS events and display a real-time graphic representation of power flowing through the UPS components. Backlit status indicators show the operating mode of the UPS and alert you to system events. The emergency **LOAD OFF** pushbutton is also located on the monitor panel and is described in Chapter 5, “Using the Monitor Panel.”

Control Panel

The *Control Panel* inside the right door of the UPS contains the operator controls to start and stop the UPS, change the operating mode, and reset the **LOAD OFF** pushbutton. The Control Panel is described in “Using the Control Panel” section of Chapter 4.

Communication Panel

Computer Interface

Two *serial communications ports* are standard on all units, and are electrically isolated from the UPS. You can use these ports to link the UPS to the features described in Chapter 7, “Serial Communications” and Chapter 8, “Remote Notification.”

Summary Alarm Contacts

Alarm contacts are provided for connection to equipment at your facility, such as a light, an audible alarm, or a computer terminal. The equipment you connect to these contacts alerts you to a UPS alarm. This feature is described further in Chapter 6, “Using Features and Options.”

Building Alarm Monitoring

You can connect your facility’s alarm system contacts to six (6) inputs in the UPS. The UPS uses these inputs to monitor your building alarms in addition to the UPS status. This feature is described further in Chapter 6, “Using Features and Options.”

Input Filter

Your unit may be equipped with an *input filter*. An *input filter* yields power factor correction that allows you to save on your initial installation and operating costs. The filter also reduces input harmonic current distortion and minimizes upstream interference that can damage sensitive hardware components.

Emergency Load Off

A **LOAD OFF** pushbutton is provided for situations where you must immediately remove all power to your critical load. The pushbutton is located on the front of the UPS for quick access and is covered with a clear plastic shield to prevent inadvertent operation. The shield must be raised before pressing the pushbutton. The **LOAD OFF** pushbutton is described in detail in Chapter 12, “Using the **LOAD OFF** Pushbutton.”

Automatic Battery Charge Current Limit

A preset limit restricts battery charging current to protect batteries from damage due to high current charging. Charging at high currents can overheat and damage batteries.

Installation Features

Power and control wiring can be routed through the top or bottom of each UPS cabinet. Each cabinet has an *internal wireway*.

Options and Accessories

Contact your sales representative for information about any of these available options:

Battery

You can enhance the protection provided by your UPS with one or more backup battery supplies equipped with sealed lead-acid, maintenance-free batteries in a matching cabinet. Each battery cabinet contains individual modular battery trays and a battery circuit breaker. Several battery capacities are available.

The UPS battery cabinets can be paralleled; you can increase your battery backup time by adding battery cabinets to your UPS system. Your UPS system can support up to four (4) battery cabinets.

External Battery Disconnect

An optional DC circuit breaker, enclosed in a wall-mounted box adjacent to the UPS, provides a manual means of disconnecting a battery that is located remotely from the UPS. This option is described further in Chapter 6, "Using Features and Options."

Power Distribution Module (available for North American voltages only)

An optional output *power distribution module* (PDM) is available to distribute the output power of the UPS to your critical load. The PDM cabinet has two panels, each containing 40 poles for breaker switches you can assign with flexibility to meet the needs of your facility. Each panel is controlled by one 225 amp feeder breaker. The PDM is enclosed in a separate cabinet that matches the UPS.

Upgrade Capability

The UPS is available in various output power ratings in both 50 and 60 Hz models. If your power requirements increase, you can upgrade your UPS system to provide more output power with a minimum impact on your facility.

Remote Monitor Panel

An optional *Remote Monitor Panel* (RMP) contains backlit status indicators and a local horn, allowing you to monitor the operational status and alarm condition of the UPS from virtually any location within your facility. You can install multiple RMPs at remote locations to increase your monitoring capabilities. This option is described further in Chapter 6, "Using Features and Options."

Relay Interface Module

An optional *Relay Interface Module* (RIM) uses relay contact closures to indicate the operating status and alarm condition of the UPS system. The module uses a serial interface line and may support up to eight critical loads. This option is described further in Chapter 6, "Using Features and Options."

Isolation Transformer

An optional voltage-stepping *input isolation transformer* provides an isolated input to the rectifier for applications that require a DC link that is not ground referenced. The transformer is contained in a matching cabinet. The *input isolation transformer* option is not available with a Powerware 9315 40 or Powerware 9315 50 UPS cabinet.

Modem

An optional modem is available for use with the UPS Remote Notification feature described in Chapter 8, "Remote Notification". Refer to the manual supplied with the modem for modem operating instructions.

Customer Convenience Outlet

An uninterruptible 120VAC, 0.2 amp, fuse-protected convenience outlet is provided with the optional modem. It is located adjacent to the Communications Panel.

Safety Considerations

The UPS enclosures are designed for industrial or computer room applications, and contain safety shields behind the doors. However, the UPS is a sophisticated power system and should be handled with appropriate care, following these guidelines:

- **Keep surroundings clean and free from excess moisture.**
- **Do not operate the UPS close to gas or electric heat sources.**
- **The system is not intended for outdoor use.**
- **The UPS operating environment should be maintained within the parameters stated in this manual.**
- **Keep the UPS doors closed to ensure proper cooling airflow and to protect personnel from dangerous voltages inside the unit.**
- **The UPS contains its own power source. Lethal voltages are present even when the UPS is disconnected from utility power.**

<p>WARNING: Only AUTHORIZED SERVICE PERSONNEL should perform service or maintenance on the UPS or battery.</p>
--

If service or routine UPS maintenance is required:

- **Ensure all power is disconnected before performing installation or service.**
- **Ensure the area around the UPS system is clean and uncluttered.**
- **Battery cabinet maintenance or battery replacement should be performed only by authorized service personnel.**
- **Observe all DANGER, CAUTION, and WARNING notices affixed to the inside and outside of the equipment.**
- **Always conform to the more detailed safety precautions described in "Important Safety Instructions" section of Chapter 9.**

Symbols, Controls, and Indicators

These symbols may appear on your UPS system or on labels inside the UPS. They are accepted by most international safety agents. Everyone in your organization who works with your UPS should understand the meaning of these symbols:



ON

The principal power switch is in the “On” position.



OFF

The principal power switch is in the “Off” position.



PHASE

The word “phase.”



CAUTION: REFER TO MANUAL

Stop and refer to the Operator’s Manual for more information.



RISK OF ELECTRIC SHOCK

There is a risk of electric shock present, and you should observe associated warnings. The UPS contains high voltages.

3

Understanding UPS Operation

Your UPS functions automatically to supply AC electrical power to your critical load. The UPS always operates in one of three modes:

- In *Normal* mode, the critical load is supplied by the inverter, which derives its power from rectified utility AC power. In this mode, the rectifier also provides charging current for the battery.
- In *Battery* mode, the battery cabinet provides DC power, which maintains inverter operation. The battery supports the critical load.
- In *Bypass* mode, the critical load is directly supported by the utility through an isolation transformer.

The UPS continually monitors itself and the incoming utility power, and automatically switches between these modes as required, with no operator intervention. The sophisticated detection and switching logic inside the UPS ensures that operating mode changes are automatic and transparent to the critical load. The UPS switches operating modes in response to these *system events*:

- A *command* is an intervention that is externally initiated by an operator or by some site action. A command causes the UPS to switch operating modes; it usually does not require any further action by you.
- A *notice* is a minor system event that may or may not require your attention.
- An *alarm* is a system event that requires immediate operator intervention.

System events, alarm horns, and indicator lights are described in Chapter 11, "Responding to System Events."

Normal Mode

In Normal mode, utility AC power is supplied to the rectifier. The rectifier supplies DC power to the inverter, which then supplies the critical load with AC power. The rectifier also provides charging power to the battery. The battery charge condition is monitored by the UPS and reported by a status indicator on the Monitor Panel. The message “System Normal” appears in the status area of the LCD screen.

Figure 3 shows the path of electrical power through the UPS system when the UPS is operating in Normal mode.

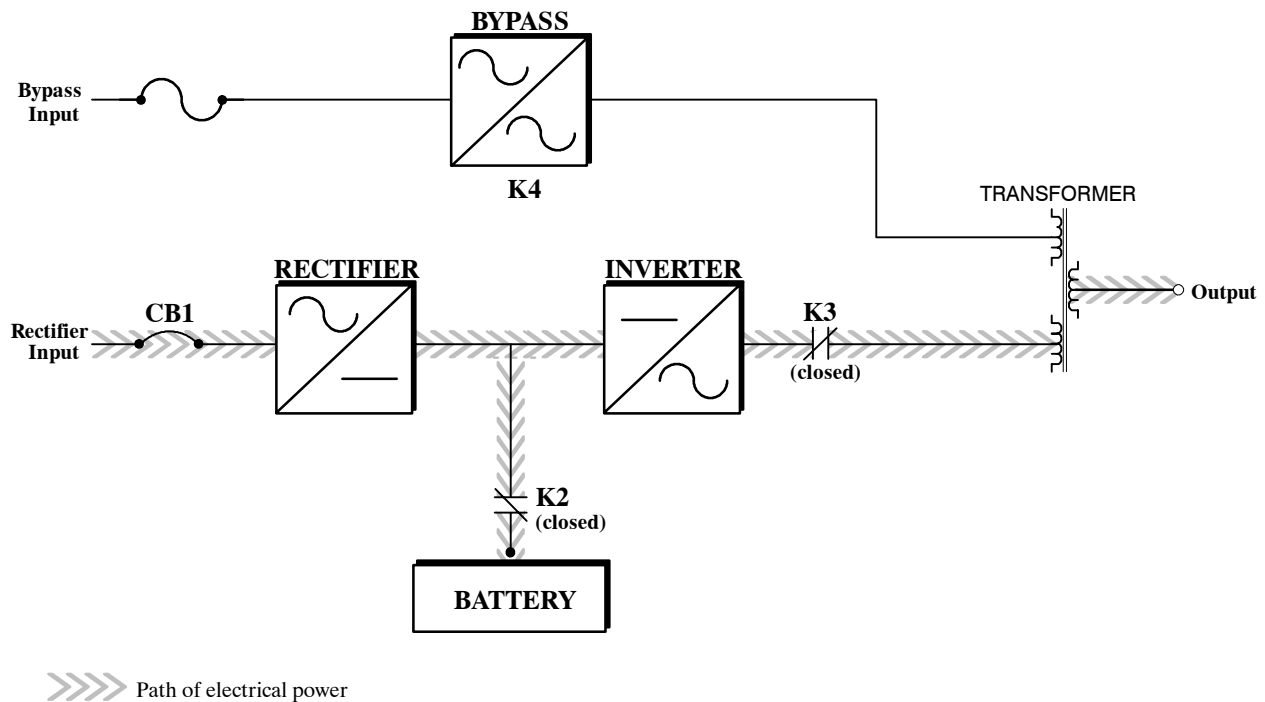

Figure 3. Path of Current Through the UPS in Normal Mode

If the utility AC power is interrupted or is out of specification, the UPS automatically switches to Battery mode to support the critical load with no interruption. When utility power returns, the UPS returns to Normal mode.

If the UPS system becomes overloaded, the UPS switches to Bypass mode. The UPS automatically returns to Normal mode when the error condition is cleared and system operation is restored within specified limits.

If the UPS suffers an internal failure, it switches automatically to Bypass mode and remains in that mode until the failure is corrected and the UPS is back in service.

Bypass Mode

The UPS automatically switches to Bypass mode if it detects an overload, load fault, or internal failure. The bypass source supplies the commercial AC power to the load through an internal switch and an internal transformer.

CAUTION:
The critical load is not protected while the UPS is in Bypass mode.

Figure 4 shows the path of electrical power through the UPS system when the UPS is operating in Bypass mode.

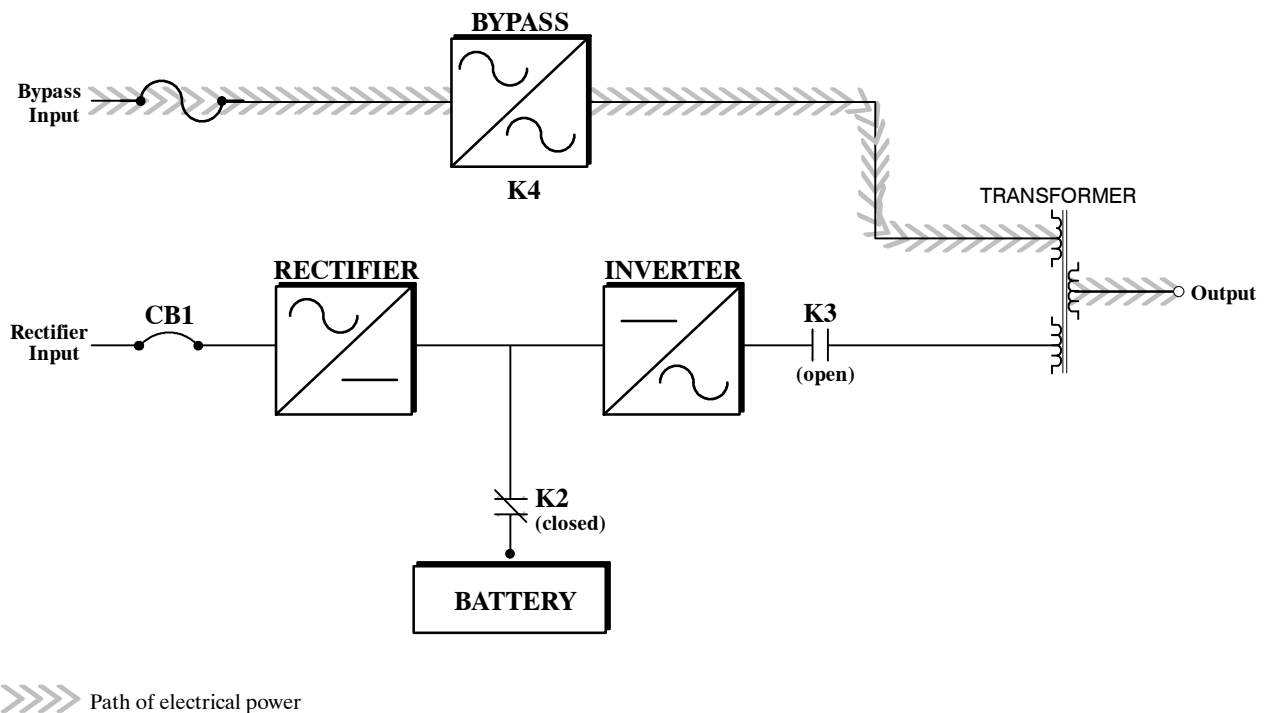

Figure 4. Path of Current Through the UPS in Bypass Mode

You can transfer the UPS from Normal mode to Bypass mode manually. However, the UPS switches automatically to Bypass mode whenever the inverter can no longer supply the critical load. If the UPS transfers to Bypass mode from Normal mode due to any reason other than operator intervention, the UPS automatically attempts to transfer back to Normal mode (up to three times within a 10-minute period).

Bypass mode is a normal operating mode, and not an alarm condition. However, if the UPS is unable to return to Normal mode following an automatic transfer to Bypass mode, an alarm condition will be recorded.

Battery Mode

The UPS transfers to Battery mode automatically if a utility power outage occurs, or if the utility power does not conform to specified parameters. In Battery mode, the battery provides emergency DC power that the inverter converts to AC power. When the UPS switches to Battery mode, the alarm indications depend on the cause and condition of the battery charge. The length of time the system can operate in Battery mode depends on loading and the battery supply capacity.

Figure 5 shows the path of electrical power through the UPS when operating in Battery mode.

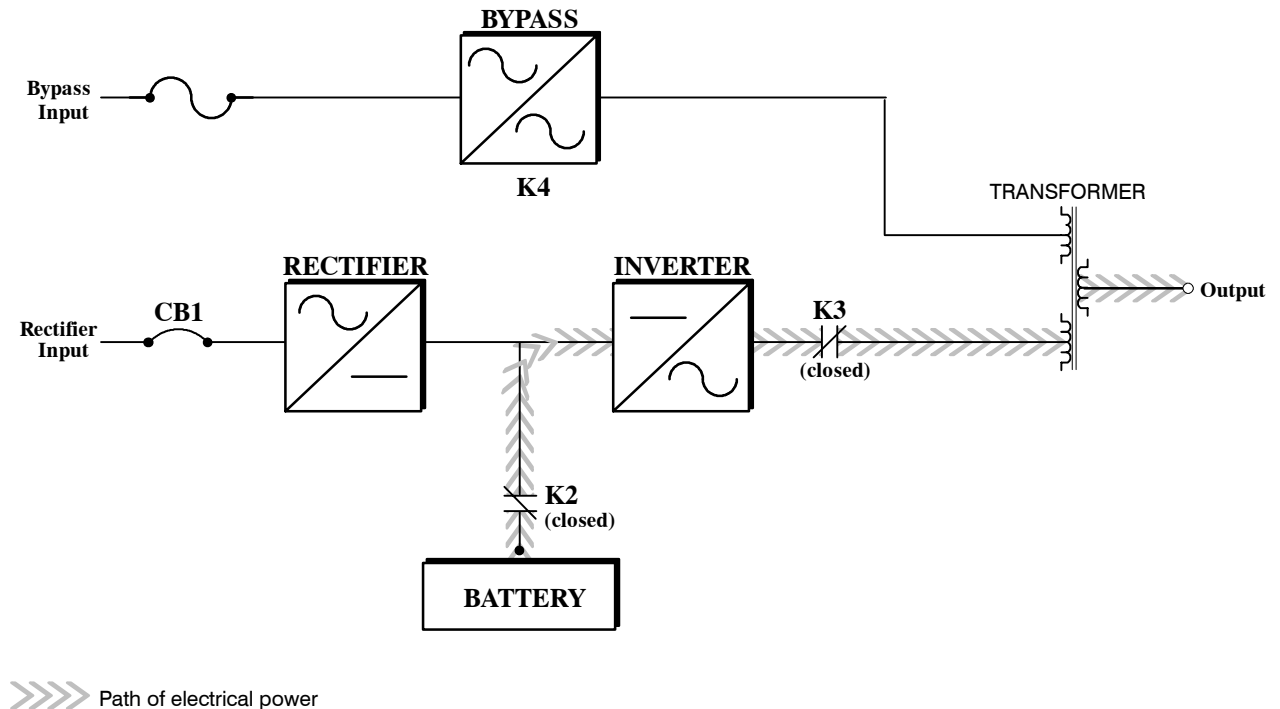

Figure 5. Path of Current Through the UPS in Battery Mode

When the discharging battery voltage reaches the lower limit of UPS operation capability, the critical load transfers to Bypass mode if it is available. If Bypass input is not available, a “Shutdown Imminent” warning occurs. The warning time before critical load loss occurs is approximately 2 minutes, depending on battery capacity and the amount of loading.

If incoming power returns to within specified parameters, the UPS automatically returns to Normal mode and alarm indications clear. However, the process of returning to Normal mode is not instantaneous. The rectifier gradually draws increasing power from the incoming utility until Normal mode is achieved.

Monitoring and Controlling UPS Operation

After you start the UPS, no operator intervention is necessary except for periodic checks of the UPS status. Manual operation is required only during routine maintenance or service. Use the Monitor Panel and the Control Panel to monitor and control the UPS. Figure 6 shows the location of these two panels on the front of the UPS.

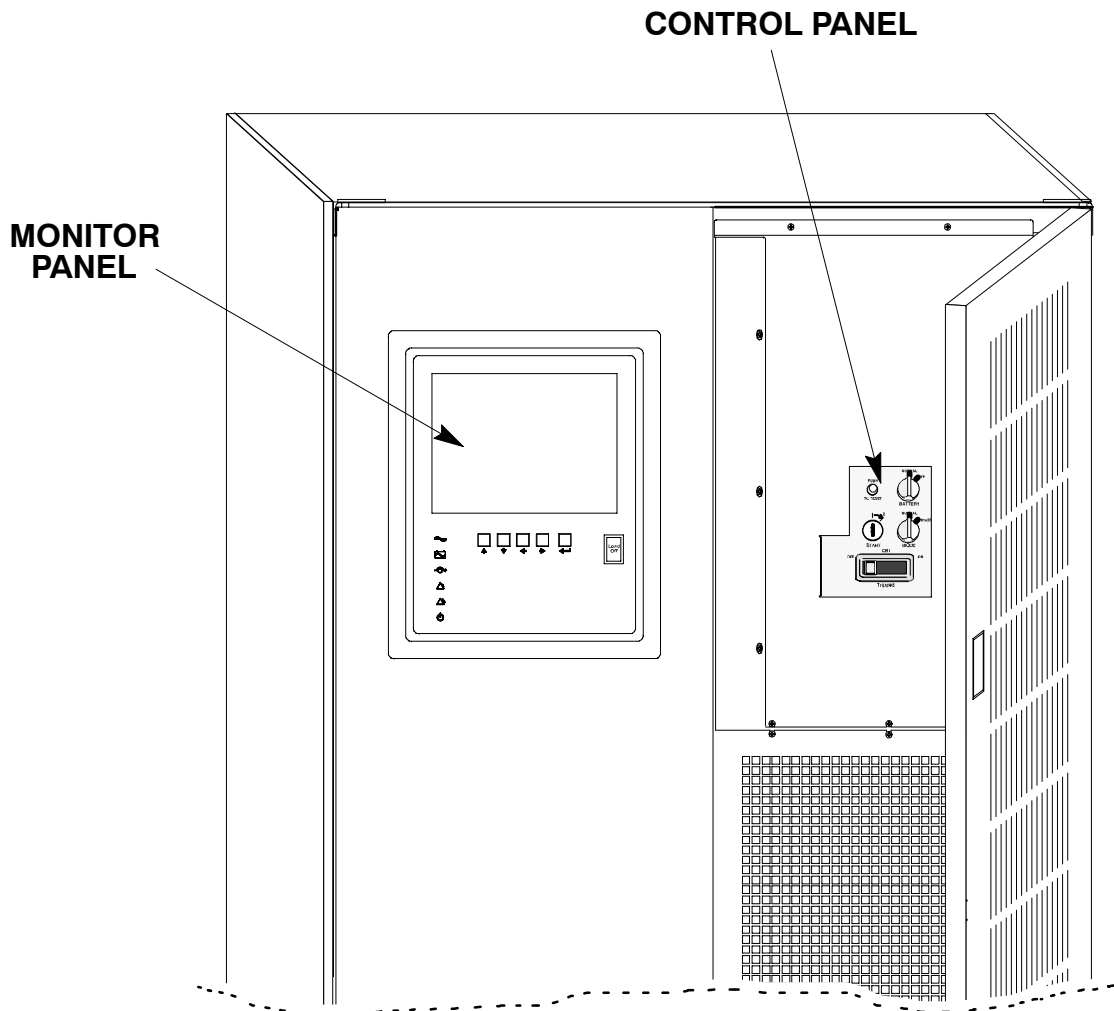

Figure 6. Location of the Monitor Panel and the Control Panel

The *Monitor Panel* on the left front of the UPS continually indicates the present mode of UPS operation. This panel contains an LCD screen, backlit status indicators, and the **LOAD OFF** pushbutton. Use the LCD screen on the Monitor Panel to view performance meters or graphic representations of UPS operation. The Monitor Panel is described in detail in Chapter 5, “Using the Monitor Panel.” A quick reference label describing how to use the Monitor Panel is located inside the UPS above the Control Panel.

Open the right front door of the UPS to view the *Control Panel* containing various controls and switches. These control power to and from the UPS, and allow you to change the UPS mode manually. The Control Panel is discussed in Chapter 4.

This Page Intentionally Left Blank.

4

Starting and Stopping the UPS

This chapter describes how to use the Control Panel to start and stop the UPS.

NOTE: Before starting the UPS, ensure all installation tasks are complete and a preliminary startup has been performed by authorized service personnel. The preliminary startup verifies all electrical interconnections to ensure the installation was successful and the UPS system operates properly.

Using the Control Panel

The Control Panel (see Figure 7) is inside the right door of the UPS cabinet. Although the Control Panel appears easy to use, you should read these instructions and thoroughly understand how the controls work before attempting to use them.

CAUTION:
Incorrect use of the power controls on the Control Panel can cause a loss of power to your equipment.

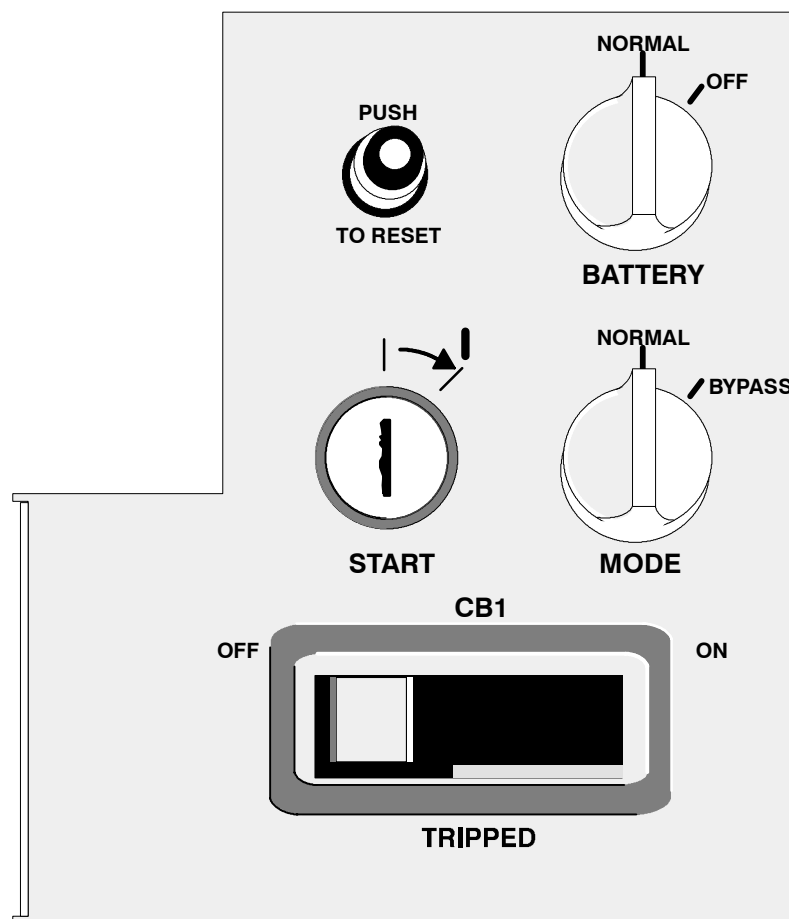

Figure 7. UPS Control Panel

The following describes the switches on the Control Panel (see Figure 7):

- The **MODE** switch is a two-position rotary switch that controls the manual transfer of the UPS to and from Bypass mode. The **MODE** switch is used to:
 - Place the critical load in Bypass mode when the UPS is operating in Normal mode and the bypass source is within acceptable limits. If the transfer does not occur within 2 seconds, an alarm sounds.
 - Prevent transfer to Normal mode when the UPS is in Bypass mode.
 - Shut down the *power processing unit* (inverter and rectifier) of the UPS.
- The **BATTERY** switch is a two-position rotary switch that allows you to manually enable or disable the battery contactor.
- The circuit breaker (**CB1**) switch controls the operation of the rectifier and inverter. If CB1 is on (closed), the rectifier turns on when the **START** switch is activated and the proper voltage is at the input terminals.
- The **PUSH TO RESET** pushbutton is described in the “Resetting the UPS System after Load Off” section of Chapter 12.
- The **START** switch activates the power controls on the Control Panel. The **START** switch is center-biased (the key will rest only in the upright position). Its operation is similar to that of an automobile ignition switch. After setting the operator controls, you turn the **START** switch to the right momentarily to activate the controls. When you release it, it returns to the upright position.

The following sections describe how to operate these controls to start, stop, or change the operating mode of the UPS.

To Place the UPS in Normal Mode:

1. Move the **CB1** switch to **ON**.
2. Turn the **BATTERY** switch to **NORMAL**.
3. Turn the **MODE** switch to **NORMAL**.
4. Be sure the Load Off **PUSH TO RESET** pushbutton is pressed in.
5. Turn the **START** switch to the right momentarily.

The rectifier turns on, then the inverter turns on. When the inverter reaches full voltage, it turns on and supplies power to the critical load. It takes less than 1 minute for the UPS to achieve Normal mode.

If a bypass source is available when you turn the **START** switch on, the critical load is immediately supplied by the bypass source in Bypass mode until the inverter turns on and the UPS transfers to Normal mode. The status indicators on the Monitor Panel indicate when the UPS is in Bypass mode and Normal mode.

To Shut Down the UPS from Normal Mode:

1. Turn the **MODE** switch to **BYPASS**.

The UPS switches to Bypass mode. If the bypass source is not available, the power processor remains on and an alarm sounds.

2. When the transfer is complete (the LCD screen reads "On Bypass"), move the **CB1** switch to **OFF**.

The bypass source supplies the critical load and the power processor de-energizes. The Bypass mode indicator illuminates on the Monitor Panel.

To Start the UPS in Bypass Mode:

If the power processing unit (PPU) of the UPS is not available and you need to energize your critical load right away, you can energize your critical load without the benefit of backup. To turn the UPS on in Bypass mode:

1. Turn the **MODE** switch to **BYPASS**. (The remaining switches can be in any position.)
2. Turn the **START** switch to the right momentarily.

Power to the critical load is supplied by the bypass source. No backup is available.

To Shut Down Power to the Critical Load While in Bypass Mode:

To perform maintenance or service on your critical load, you must shut it down first:

1. Turn off all equipment that is being powered through the UPS.
2. Press the **LOAD OFF** pushbutton on the Monitor Panel.

This Page Intentionally Left Blank.

5

Using the Monitor Panel

This chapter describes the Monitor Panel and how to monitor and control UPS operation. The Monitor Panel is a black rectangular area on the front of the UPS (see Figure 8).

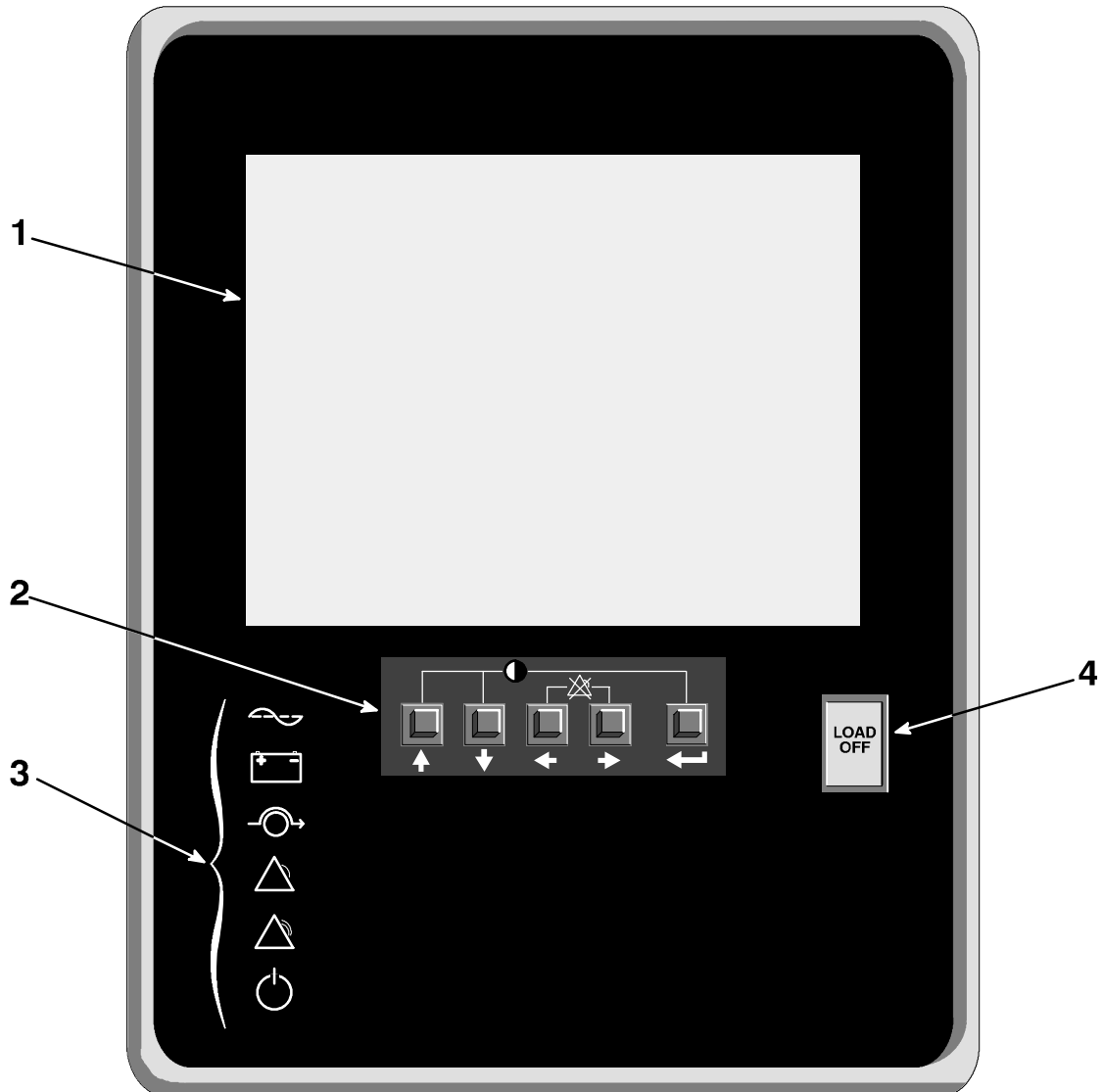

Figure 8. UPS Monitor Panel

The Monitor Panel contains a flat liquid crystal display (LCD) screen (1), a horizontal row of pushbuttons (2), a vertical column of backlit status indicators (3), and the red **LOAD OFF** pushbutton (4). A quick reference label describing how to use the Monitor Panel is located inside the UPS above the Control Panel. The following sections describe the Monitor Panel in detail.

Using the LCD Screen

The LCD screen at the top of the Monitor Panel provides an operator interface with the UPS. Figure 9 identifies the display fields discussed in the following sections.

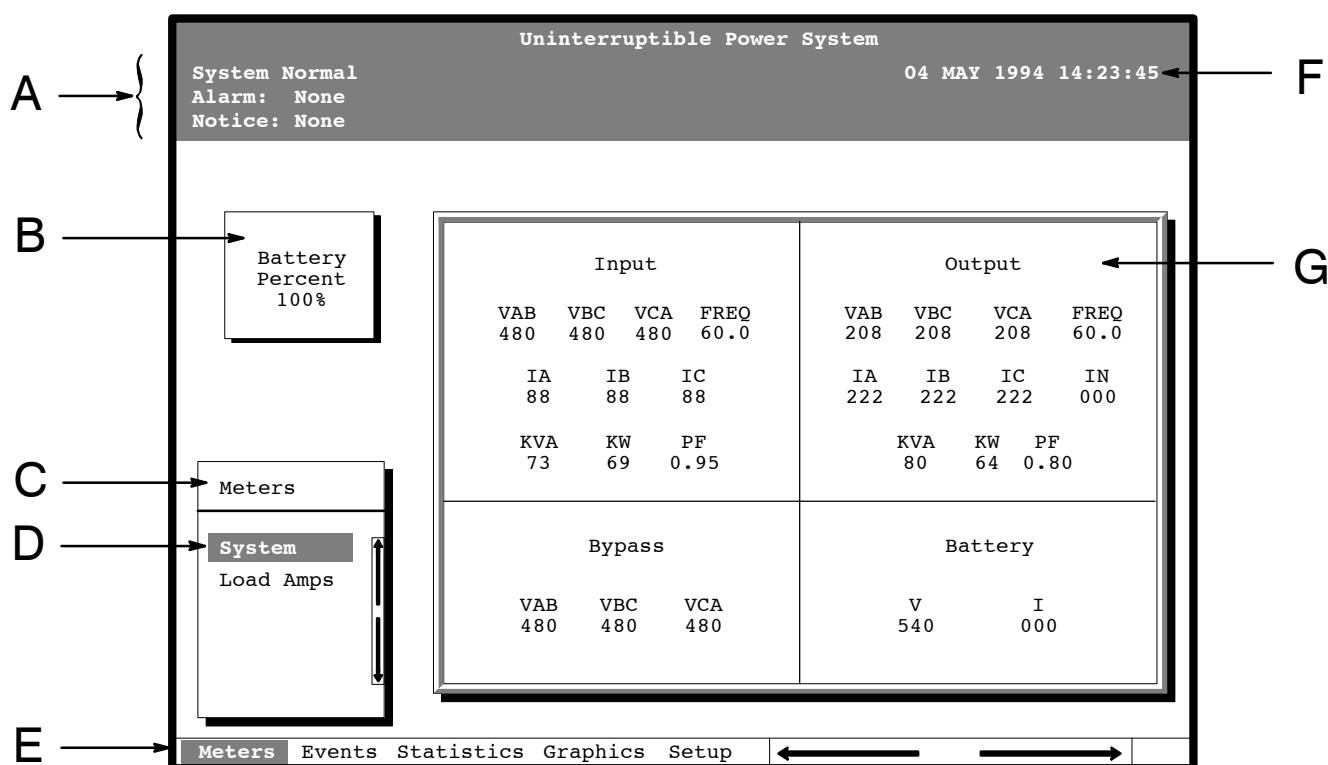

Figure 9. Parts of the LCD Screen (Typical for Powerware 9315 80 480/208V Unit)

- A** The *UPS status area* contains three lines that display the current state of the UPS. The first line shows the present operational mode of the UPS. The second line shows the highest level of the current active alarms, and the third line shows any notices the UPS has posted. (For more information about alarms and notices, refer to Chapter 11, “Responding to System Events.”)
- B** The *battery charge box* shows the percentage of battery capacity available.
- C** The *menu box* shows the currently selected menu and lists the options available on that menu. The title at the top of the menu box is also shown below on the menu bar (**E**). Press the \uparrow and \downarrow pushbuttons to scroll up and down through the options in the menu box.
- D** The currently selected *option* is highlighted in the menu box. Press the \uparrow and \downarrow pushbuttons to move the highlight up or down. The data in the information area (**G**) changes accordingly.
- E** The *menu bar* lists the titles of the menus. The title of the menu currently displayed in the menu box is highlighted. When you press the \leftarrow and \rightarrow pushbuttons to move the highlight left or right, the data in the menu box and the information area change accordingly.
- F** The *timestamp* shows the current date and time. This date and time are recorded in the Event Log when a notice or alarm is activated.

- G** The *information area* contains data about UPS status and operations. Select a menu option to display statistics or graphics.





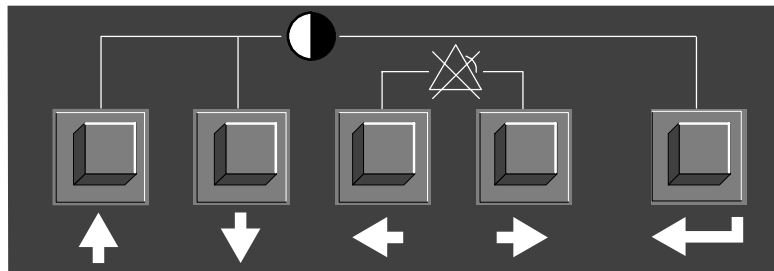

You can use the LCD screen and the pushbuttons beneath it to:

- Monitor UPS operation
- Look at a log of UPS events (alarms, notices, and commands).



Using the Pushbuttons

The *pushbuttons* below the LCD screen are labeled with arrows indicating their functions:



- Press the  and  pushbuttons to move through the options in a menu, or to scroll through the list of alarms and notices in the event log.
- Press the  and  pushbuttons to move through the menu titles on the menu bar. Press them simultaneously to silence the horn, or to test the lamps behind the status indicators.
- Press the  pushbutton to toggle the use of the  and  pushbuttons between the menu box and the information area.

Adjusting the Contrast

- Use the pushbuttons to adjust the contrast on the LCD screen. Hold down the  pushbutton, then press the  pushbutton to increase the contrast or the  pushbutton to decrease the contrast.

Using the Load Off Pushbutton

The **LOAD OFF** pushbutton is red and covered by a clear plastic shield. In an emergency, you can press this pushbutton to cut off utility power to the power processing unit of the UPS and to your critical load. For more information, refer to Chapter 12, “Using the **LOAD OFF** Pushbutton.”

CAUTION: All power to the critical load is lost when you press the LOAD OFF pushbutton. You should use the LOAD OFF pushbutton only when you want to de-energize the critical load.

Reading the Status Indicators

The six symbols on the left side of the monitor panel are *status indicators*. They are backlit by colored light emitting diode (LED) lamps, and they work in conjunction with the alarm horn to let you know the operating status of the UPS.

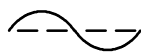

Normal

This green symbol is lit when the UPS is operating in Normal mode. The power processing unit (PPU) is supplying power to the critical load.

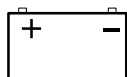

Battery

This yellow symbol is lit when the UPS is operating in Battery mode. Because Battery mode is a normal condition of the UPS, the Normal indicator also remains lit.





Bypass

This yellow symbol is lit when the UPS is operating in Bypass mode. The critical load is supported by the bypass source. The Normal indicator is not lit when the system is in Bypass mode.





Notice

This yellow symbol is lit when the system needs attention. The LCD screen shows all active notices. Some notices may be accompanied by an audible horn. To silence the horn, press the  and  pushbuttons simultaneously. The Notice indicator may be lit along with other indicators.



Alarm



This red symbol is lit when a situation requires immediate attention. The LCD screen shows the highest priority active alarms. All alarms are accompanied by an audible horn. To silence the horn, press the  and  pushbuttons simultaneously. The Alarm indicator may be lit along with other indicators.



Standby

This yellow symbol is lit when electricity is present in the PPU of the UPS and the Normal indicator is not lit. During normal startup, this indicator illuminates until the the UPS transfers to Normal mode, at which point the Normal indicator is lit. During normal shutdown, the Standby indicator is lit until all energy in the UPS is dissipated and shutdown is complete.

For more information about audible horns, refer to the “System Event Horns” section of Chapter 11.

To test the LED lamps behind the status indicators, press the  and  pushbuttons simultaneously for 3 seconds. All the indicators should light while you hold down these pushbuttons. If any indicator does not light, its LED may need to be replaced. Contact Customer Service if you have a problem with the indicator lamps.

Using the Menu Options

The UPS *menus* allow you to display data in the information area to help you monitor and control UPS operation. The following menus and options are available:

- **Meters** Displays UPS performance meters for the system or critical load.
- **Events** Displays the list of Active System Events and a historical log of system events.
- **Statistics** Displays statistical information about UPS operations for the battery, load, or line.
- **Graphics** Displays a real-time graphic representation of the flow of current through the internal UPS components.
- **Setup** Allows you to configure the UPS communications port and set the date and time for the timestamp.

Figure 10 shows the LCD screen as it appears when you first start the UPS. The Meters menu is displayed in the menu box, with the System option highlighted. In the information area, the system meters show their current readings.

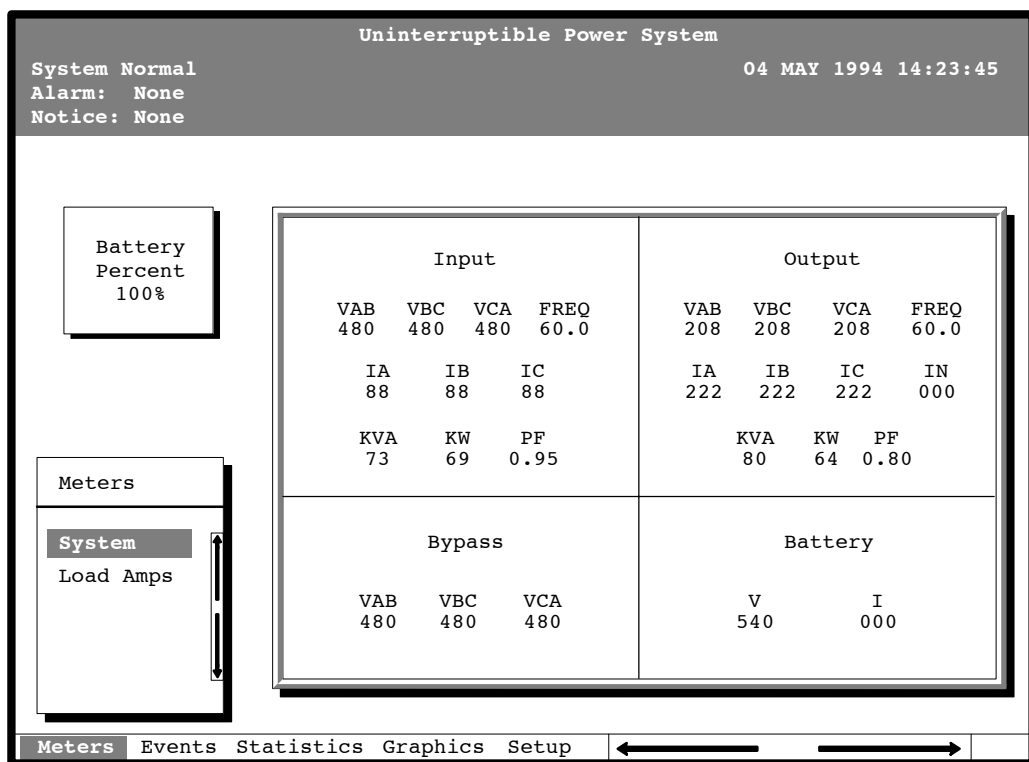

Figure 10. System Meters Screen (Typical for Powerware 9315 80 480/208V Unit)

The Input area shows the phase-to-phase voltage, frequency, and phase current of the incoming utility, followed by the KVA, KW, and power factor measurements. The output area shows the same information for the power being output by the UPS.

The Bypass area shows the phase-to-phase voltage of the bypass source. The Battery area displays the DC voltage (V) and the DC current (I).

Select **Load Amps** from the Meters menu to see a real-time bar graph of the output current of the UPS. The graph shows the current for each phase.

Figure 11 shows the Load Amps Meters screen.

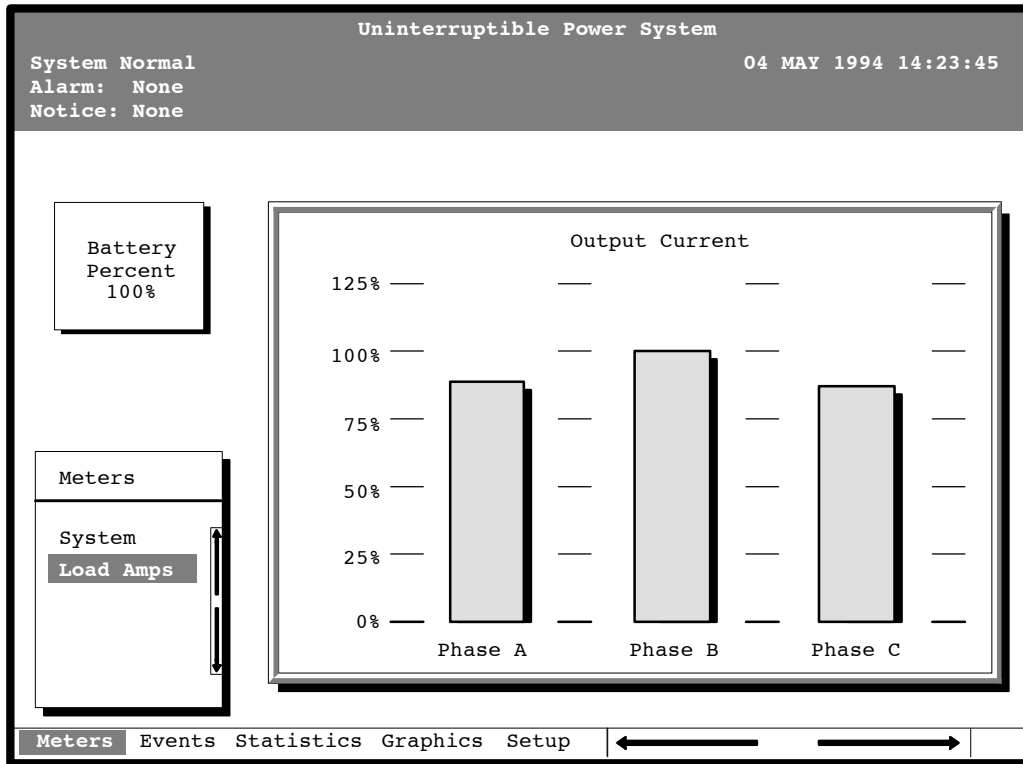

Figure 11. Load Amps Meters Screen

Select **History** from the Events menu to display the Event History Log. The Event History Log lists up to 400 system events in chronological order, with the most recent event listed last. The end of the log (the most recent events) appears when you display the screen, and you must scroll upward to view older event listings.

Figure 12 shows the Event History Log screen.

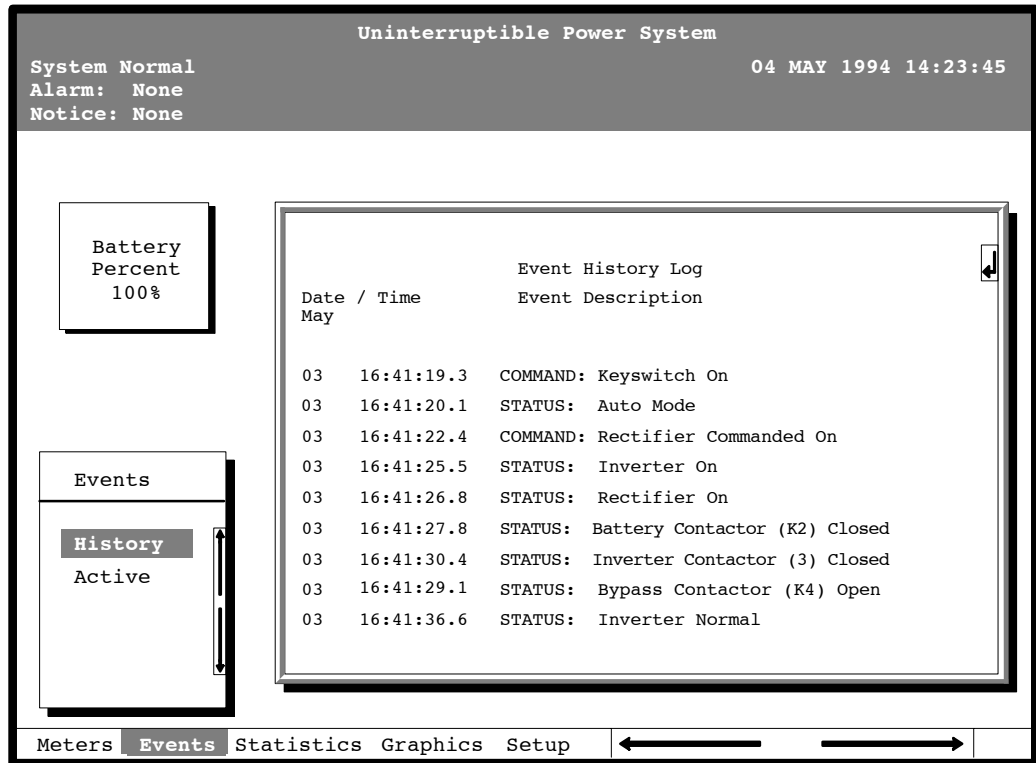

Figure 12. Event History Log Screen

A small return arrow (↩) appears in the upper right corner of the information area of the Event History Log screen. This arrow is a reminder that you can press the ↩ pushbutton on the Monitor Panel to toggle the scroll bar between the menu box and the information area. When the scroll bar is in the information area, the return arrow is in the menu box. When the scroll bar is in the menu box, the return arrow is in the information area.

When the scroll bar is in the information area, you can press the ⬆ and ⬇ pushbuttons to scroll through the Event History log.

Select **Active** from the Events menu to display a listing of all system events that are currently active. The most recent system event is listed first. As events clear, they are removed from the Active System Events listing.

Figure 13 shows the Active System Events screen.

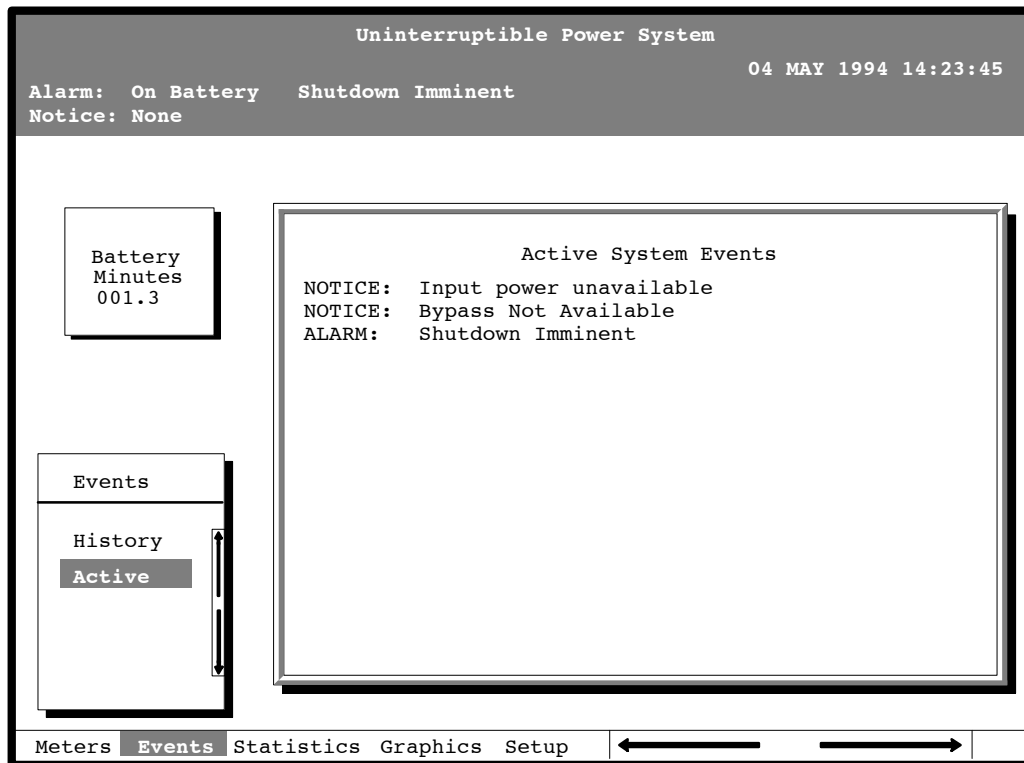

Figure 13. Active System Events Screen

Select **Unit** from the Statistics menu to display a listing of statistics about UPS operation.

Figure 14 shows the Unit Statistics screen.

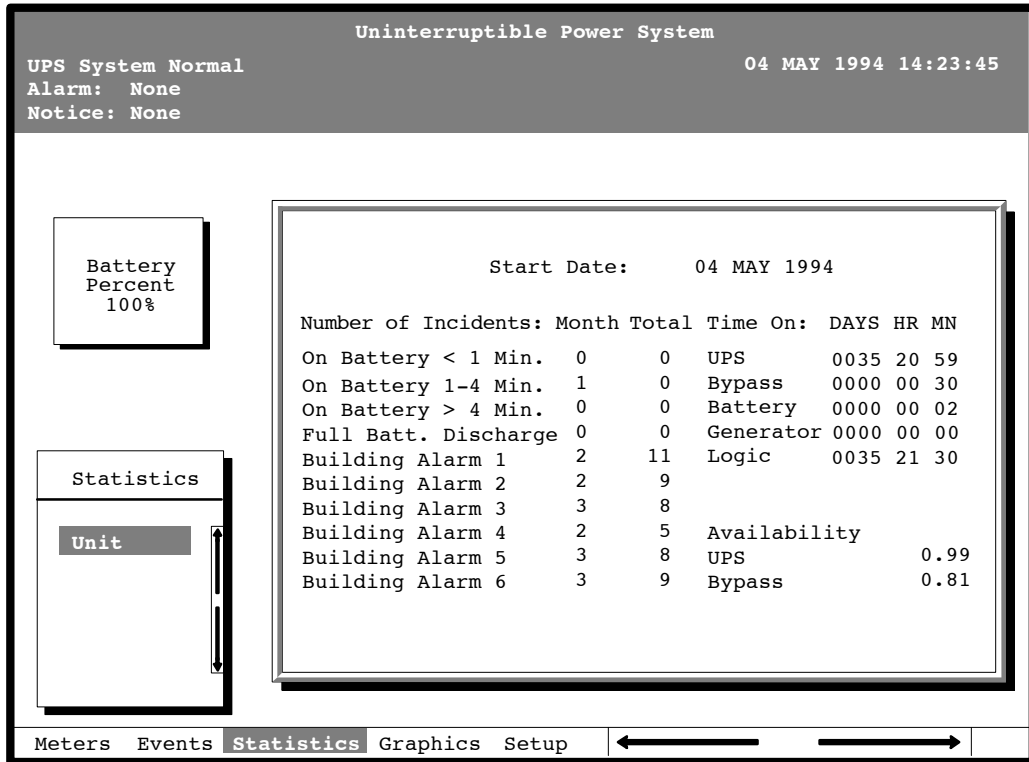

Figure 14. Unit Statistics Screen

The left column shows the number of UPS incidents for the current month and since the start date shown at the top of the screen. The top right column shows the time that the UPS was on bypass, battery, or generator, and the amount of time the UPS logic has been functioning since the start date. The lower right column shows the percent of availability of the UPS and the bypass source.

Select **Mimic** from the Graphics menu to display a real-time graphical representation of the flow of current through the UPS.

Figure 15 shows the Mimic screen.

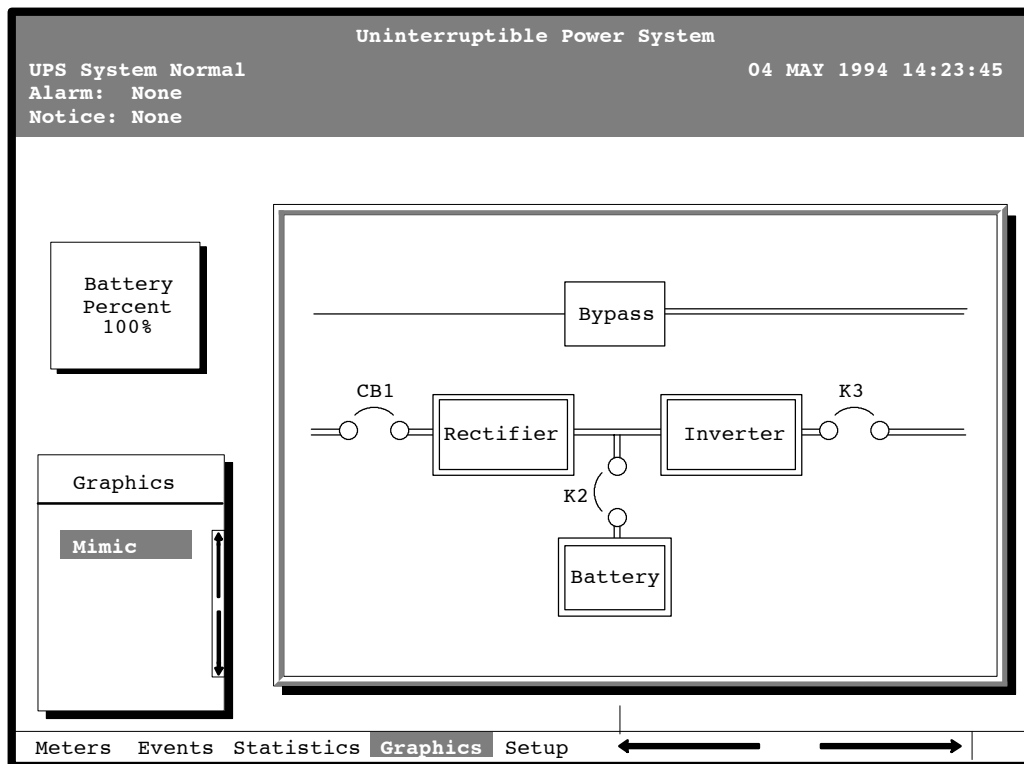

Figure 15. Mimic Screen

The Mimic screen shows the internal components of the UPS cabinet. The flow of current through the components is highlighted.

Select **Time** from the Setup menu to display the Time Setup screen. The Time Setup screen allows you to set the internal timestamp of the UPS. The timestamp is used for logging events in the Event History Log. Figure 16 shows the Time Setup screen.

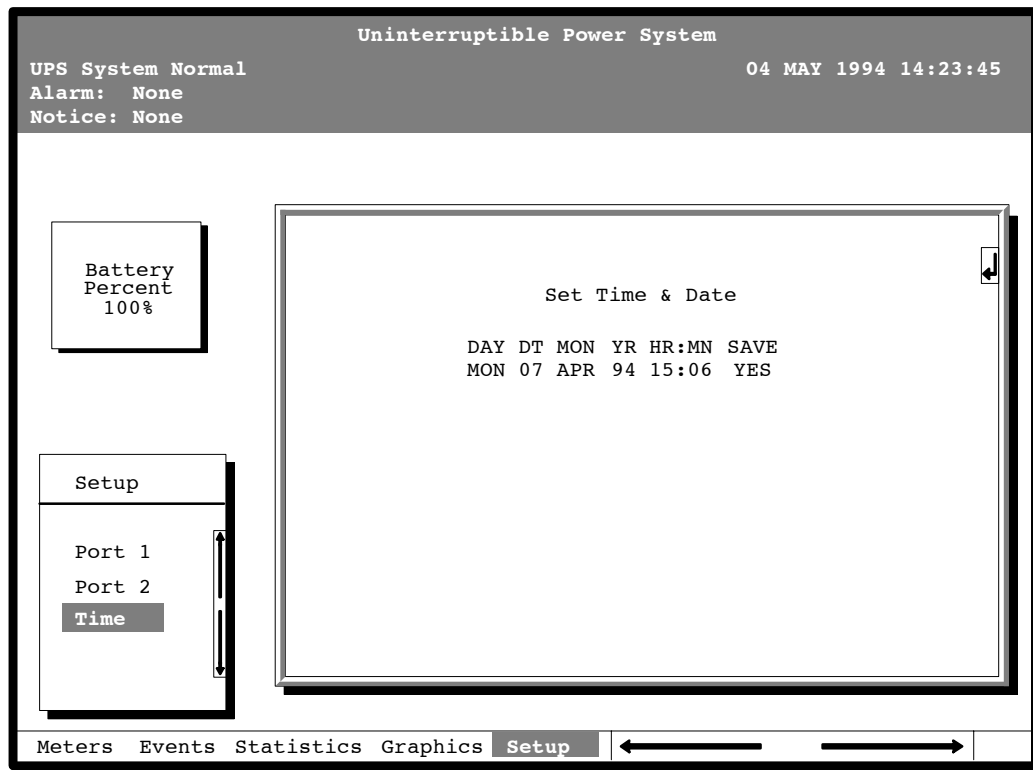







Figure 16. Time Setup Screen

The small return arrow () appears in the upper right corner of the Time Setup screen. This arrow is a reminder that you can press the  pushbutton on the Monitor Panel to toggle the pushbuttons between the menu box and the information area. When the scroll bar is in the information area, the return arrow is in the menu box. When the scroll bar is in the menu box, the return arrow is in the information area.

When the scroll bar appears in the information area, you can use the pushbuttons to change the timestamp settings. To change a setting in the timestamp, press the  and  pushbuttons to highlight the setting you want to change. To increase the setting (make it a higher value), press the  pushbutton. To decrease the setting (make it a lower value), press the  pushbutton. If you want to save the settings upon exit from this screen, be sure the **SAVE** field is set to **YES**.

Select **Port 1** or **Port 2** from the Setup menu to display one of the Port Setup screens. The Port Setup screens allow you to specify settings for the two serial communication ports on the UPS. Figure 17 shows the Setup Serial Port 1 screen.

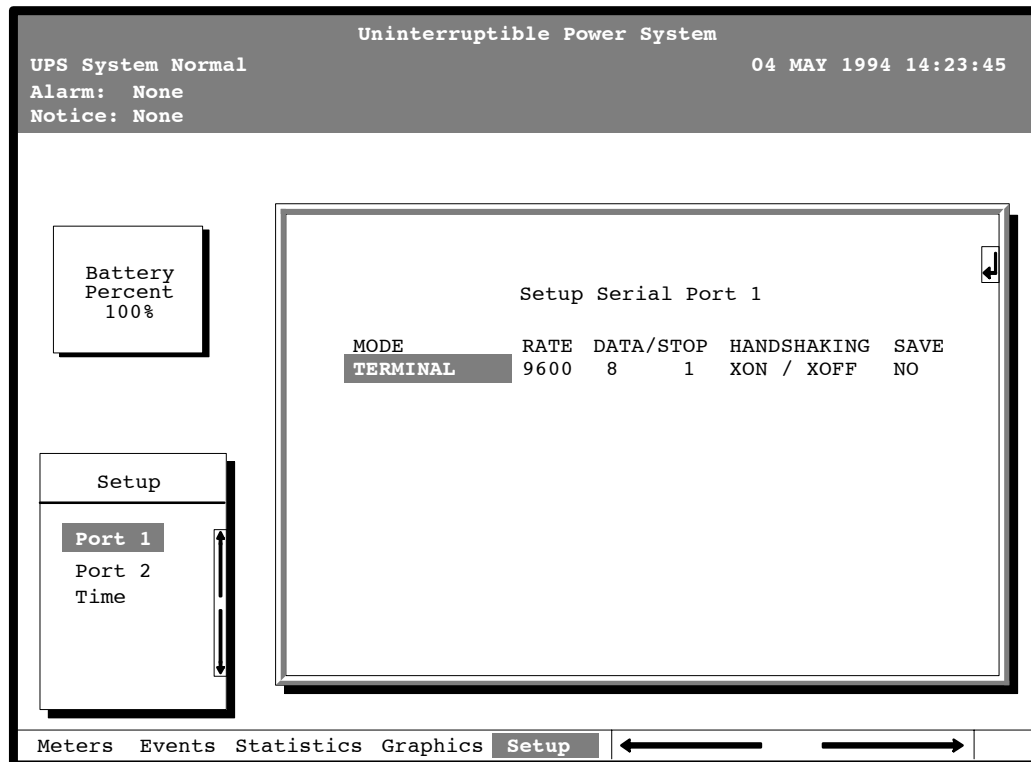







Figure 17. Port Setup Screen

The small return arrow () appears in the upper right corner of the Port Setup screen. This arrow is a reminder that you can press the  pushbutton on the Monitor Panel to toggle the pushbuttons between the menu box and the information area. When the scroll bar is in the information area, the return arrow is in the menu box. When the scroll bar is in the menu box, the return arrow is in the information area.

When the scroll bar appears in the information area, you can use the pushbuttons to change the port configuration. To change a setting, press the  and  pushbuttons to move the highlight to the setting you want to change. To scroll through the available options for that setting, press the  or  pushbutton. To save the settings upon exit from this screen, be sure the SAVE field is set to YES.

The setup screens for Port 1 and Port 2 are identical. For detailed information about configuring the serial ports, refer to Chapter 7, "Serial Communications."

6

Using Features and Options

The many standard features of your UPS provide consistent, economical, and dependable power protection. In addition, you can add available options and accessories to enhance the performance of your UPS system. This chapter provides detailed descriptions of some of the features and options introduced earlier in this manual.

Building Alarm Monitoring

This standard feature lets you connect the UPS to your building alarms, such as smoke detectors or overtemperature alarms. The terminals for external connections are located inside the UPS on the customer interface panel (see Figure 18).

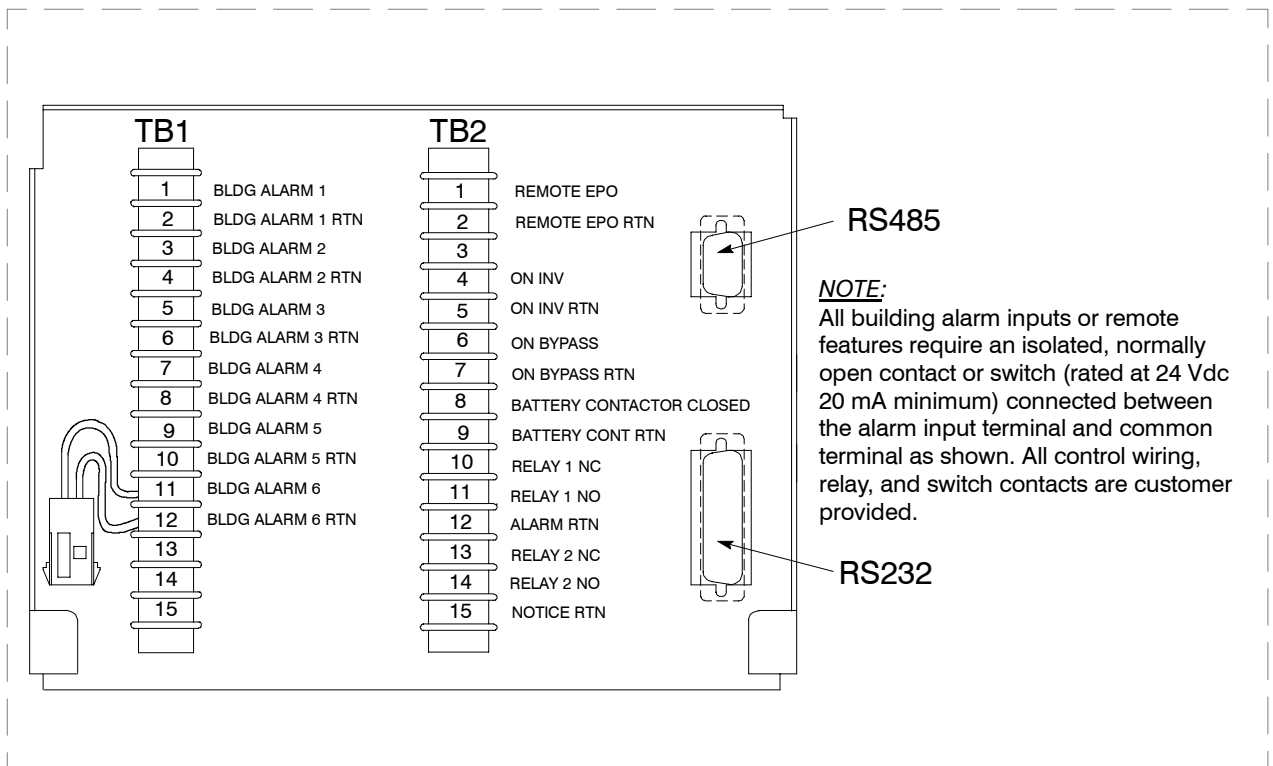

Figure 18. External Connections for Building Alarm Monitoring

Regardless of how you assign the building alarms, they display as Building Alarm 1, Building Alarm 2, Building Alarm 3, etc., on the LCD screen of the Monitor Panel. You should use twisted pair wires for each alarm input and common.

Summary Alarm Contacts

Two summary alarm contacts are provided as a standard feature on the UPS. The alarm contacts (one notice and one alarm) are located inside the UPS on the customer interface panel (see Figure 19).

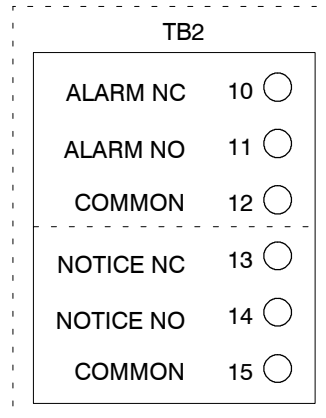

Figure 19. Summary Alarm Contacts

You can specify that each contact be either normally closed (NC) or normally open (NO). If the state of the contact changes from the state you specify as normal, an alarm is issued. You can connect these contacts to equipment at your facility (such as a light or an alarm bell) to let you know when an alarm is active on the UPS. This feature is useful if the UPS is located in a remote area where the UPS alarm horn may not be heard immediately.

CAUTION:
Contacts should not be operated in excess of 30 VAC or 42.4V peak AC or DC @ 1A maximum.

Remote Monitor Panel

As an option, you can install Remote Monitor Panels (RMPs) to monitor the operation of the UPS system from virtually any location within your facility, up to 500 feet from the UPS. Each RMP contains backlit status indicators and a local horn. You can flush-mount or surface-mount an RMP on a desktop, wall, or wherever you have a serial interface line. A maximum of two monitoring accessories (RMPs, Relay Interface Modules (RIMs), or Supervisory Contact Modules (SCMs)) can be installed. See Table 1 for the number of accessories permitted. Figure 20 shows an RMP.

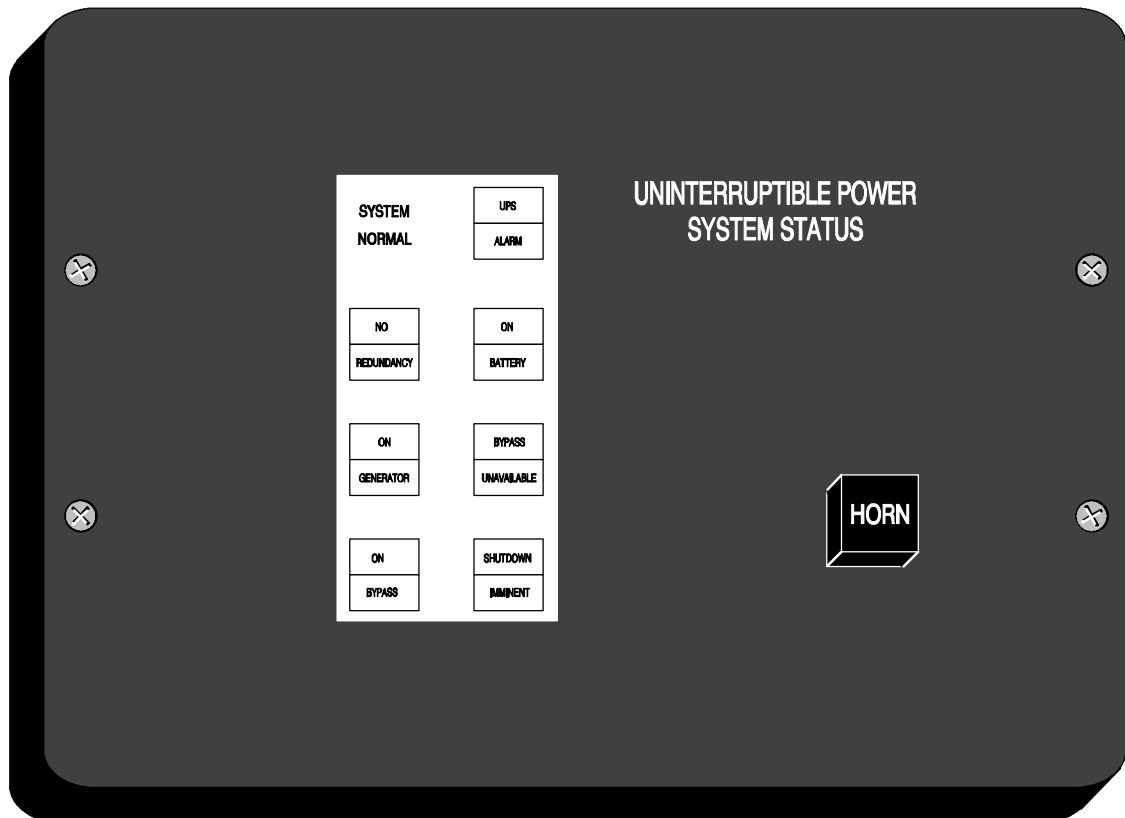

Figure 20. Remote Monitor Panel

Table 1. Optional Monitoring Accessories		
Number and Type of Accessories Permitted		
Remote Monitor Panel	Relay Interface Module	Supervisory Contact Module
2	—	—
—	2	—
—	—	2
1	1	—
1	—	1
—	1	1

The RMP contains a local horn and the following backlit status indicators:

SYSTEM NORMAL

The UPS is energized (either with utility power or battery backup) and is supplying conditioned power to the critical load.

NO REDUNDANCY

This indicator applies only to parallel systems when one cabinet is not functioning. This feature is not available on this system.

ON GENERATOR

This alarm means that the UPS input and bypass are being supplied by the power from the generator, instead of from the utility power.

ON BYPASS

The bypass source is supplying the critical load. Usually this means that the UPS is not energized. The load is not protected in Bypass mode, and a horn sounds after 30 seconds.

UPS ALARM

The UPS system is issuing an alarm. Conditions that affect the current UPS mode are indicated by the alarm lamps and horn on the UPS.

ON BATTERY

The UPS battery backup is supplying the critical load. The utility power is either interrupted or out of specification. The SYSTEM NORMAL indicator is also lit.

BYPASS UNAVAILABLE

The UPS system is in Normal mode, but a bypass source is not within specification. A horn sounds after 30 seconds.

SHUTDOWN IMMINENT

The UPS is preparing to shut down because the UPS is in Battery mode and the DC voltage is approaching its low limit. This light is accompanied by an audible alarm horn.

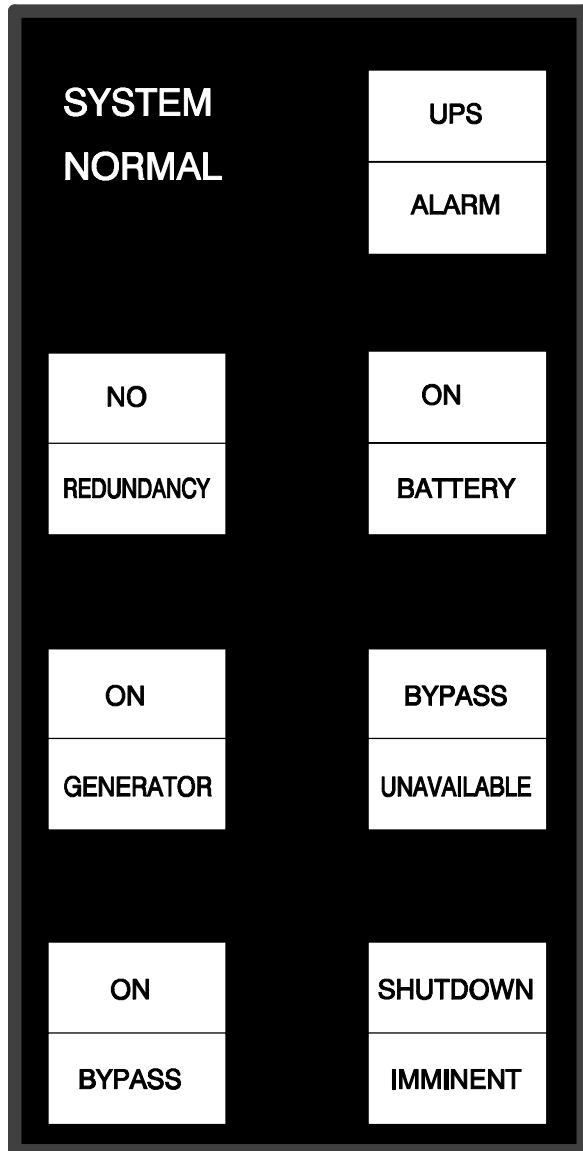

Battery Cabinets

You can enhance the protection time provided by your UPS by adding one or more battery cabinets. The battery cabinets provided by the UPS manufacturer are equipped with sealed lead-acid, maintenance-free batteries in a cabinet that matches the UPS. Each battery cabinet contains a battery circuit breaker. Several battery capacities are available.

The UPS battery cabinets can be paralleled. With this capability, you can increase your battery backup time by adding battery cabinets to your UPS system. Most UPS models can support up to four battery cabinets.

External Battery Disconnect

A breaker switch is located inside each battery cabinet supplied by the UPS manufacturer. However, due to space limitations, your battery cabinets may not be located in the same area as your UPS. An optional external DC circuit breaker provides a manual means of disconnecting a battery that is located remotely from the UPS. The circuit breaker is enclosed in a wall-mounted box. You can install it anywhere between the remote DC supply and the UPS, according to national and local codes.

The breaker switch should be set to ON for normal UPS operation when DC power is available at the UPS. When service personnel are performing maintenance on the UPS or battery cabinet, the switch should be set to OFF.

Relay Interface Module

An optional Relay Interface Module (RIM) uses relay contact closures to indicate the operating status and alarm condition of the UPS system. A maximum of two monitoring accessories (RMPs, RIMs, or SCMs) can be installed. See Table 1 for the number of accessories permitted. Figure 21 shows the RIM with its four 15-pin connectors labeled J1 through J4.

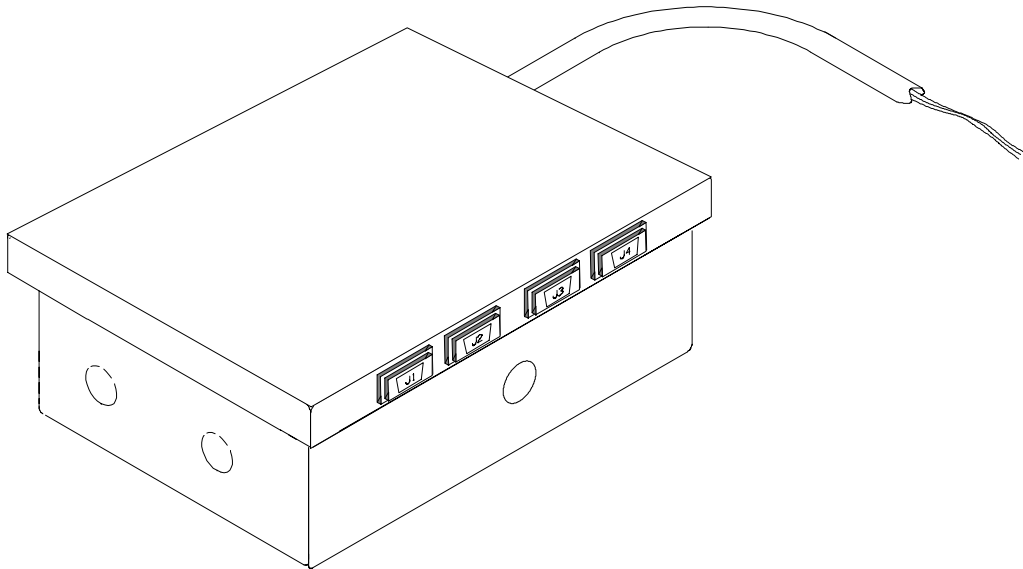

Figure 21. Relay Interface Module

The RIM can provide these signals:

- **UPS AVAILABLE** (pins 1 and 12) Contacts are closed when the UPS is offline.
- **UPS OFF LINE** (pins 3 and 13) Contacts are closed when the UPS is operating in Normal mode.
- **UTILITY FAILURE** (pins 6 and 15) Contacts are closed when Utility Failure is detected.
- **BATTERY WEAK** (pins 5 and 14) Contacts are closed when approximately 2 minutes of battery time is remaining, before the critical load is lost.

Supervisory Contact Module

An optional Supervisory Contact Module (SCM) establishes an interface between the UPS manufacturer's equipment and the customer's monitor. This interface allows the customer to monitor operational status of the UPS equipment. A maximum of two monitoring accessories (RMPs, RIMs, or SCMs) can be installed. See Table 1 for the number of accessories permitted. Figure 22 shows the SCM, input connections on TB1, and output connections on TB2.

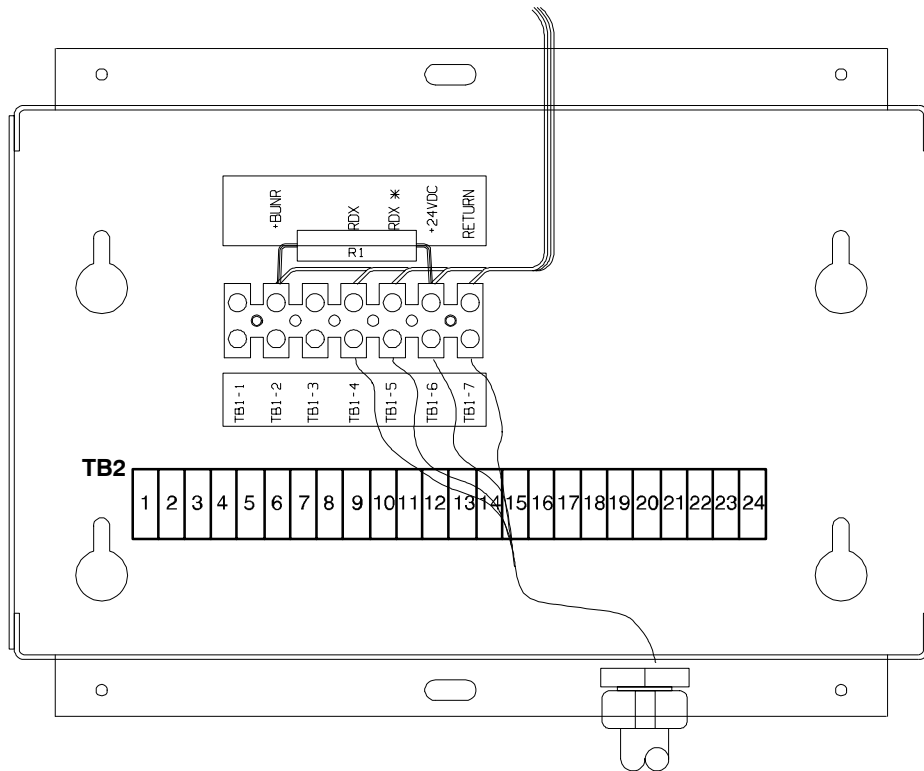

Figure 22. Supervisory Contact Module

The SCM provides signals for the following indications:

- **SYSTEM NORMAL** TB2-1 through TB2-3
- **NO REDUNDANCY** TB2-4 through TB2-6
- **ON GENERATOR** TB2-7 through TB2-9
- **BYPASS NOT AVAILABLE** TB2-10 through TB2-12
- **ON BATTERY** TB2-13 through TB2-15
- **UPS ALARM** TB2-16 through TB2-18
- **ON BYPASS** TB2-19 through TB2-21
- **SHUTDOWN IMMINENT** TB2-22 through TB2-24

Refer to Powerware 9315 Installation manual, Chapter 12, for TB2 contact configurations.

This Page Intentionally Left Blank.



Serial Communications

This chapter describes the serial communications feature of the Powerware® 9315 UPS. Two serial communications ports on the UPS let you connect equipment to view system event information.

The following sections describe the serial communications feature, and provide information about connecting hardware, setting up the ports, changing settings, and changing modes.

Locating the Communications Panel

The Communications Panel inside the UPS contains two serial communications ports, one DE-9 and one DB-25. The ports provide a computer interface to a Remote Monitor Panel (RMP), Relay Interface Module (RIM), or remote terminal and/or printer. The Communications Panel also contains terminals (TB1 and TB2) for connecting your equipment to the UPS. Figure 23 shows the location of these items inside the UPS.

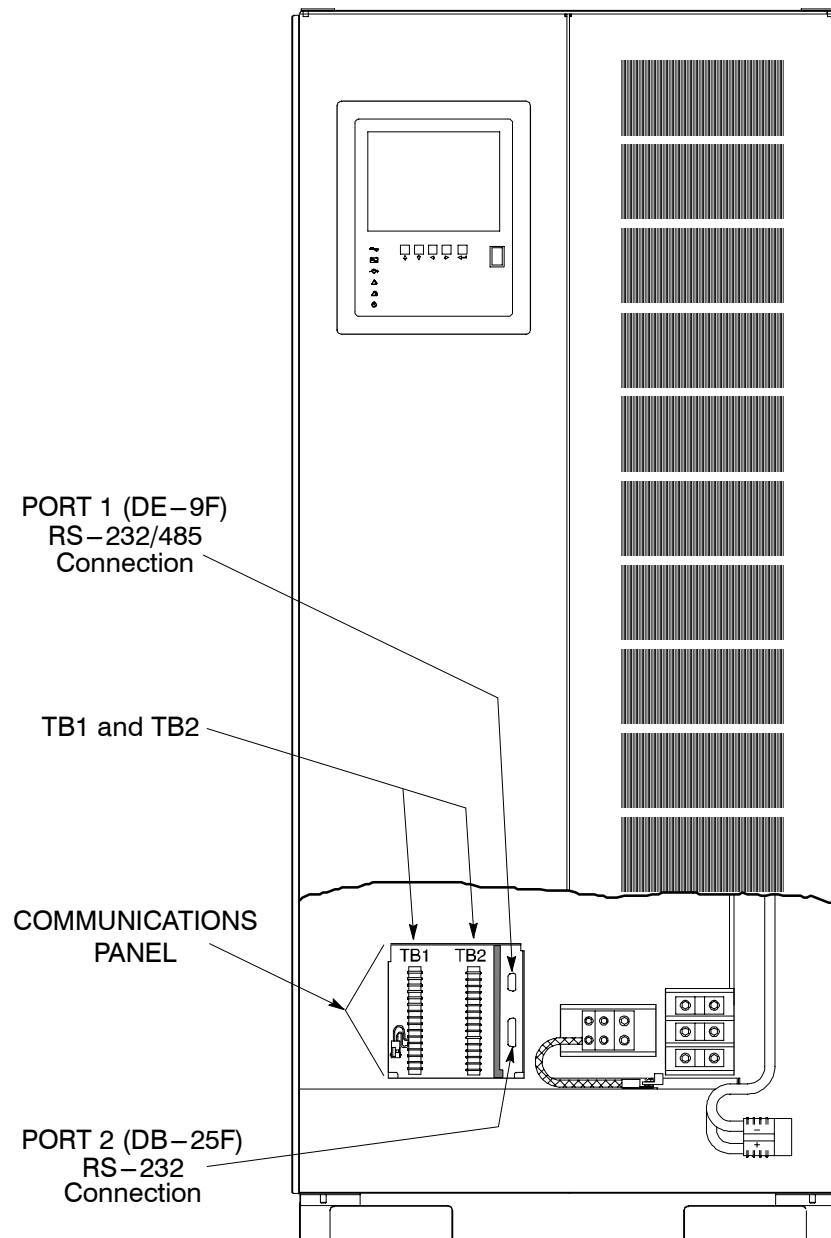

Figure 23. Location of Communications Ports on the UPS (Powerware 9315 80)

Connecting Equipment to a Serial Port

You can connect a wide variety of terminals, printers, and computers to each port, and configure the UPS as the Data Communication Equipment (DCE). Set up the remote equipment using the appropriate parameters for the mode you select. The following section provides more information about configuration.

The cables you use for connection depend on the equipment you are connecting to the UPS. Cables should be no longer than 16m (50 ft). The connectors for Port 1 and Port 2 on the Communications Panel in the UPS are female, so the cables should be male. Figure 24 shows the pin assignments for Port 1, and Table 2 describes them. Figure 25 shows the pin assignments for Port 2, and Table 3 describes them.

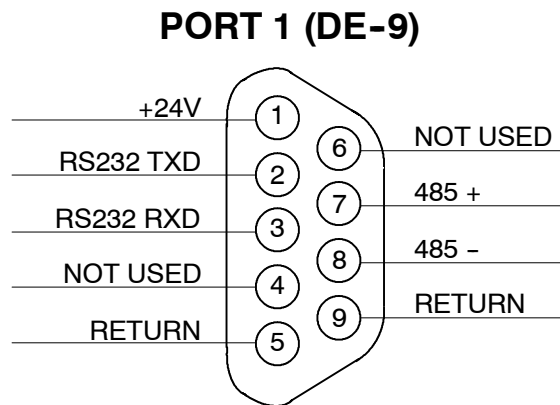

Figure 24. Port 1 Pin Assignments

Table 2. Pin Assignments for Port 1 (DE-9)			
Pin #	Symbol	Description	Comments
1	+24V	+ 24 volts DC	
2	TXD	Transmit Data	Input to UPS
3	RXD	Receive Data	Output from UPS
5	RTN	Return	
7	485+	RS485 + Data	
8	485-	RS485 - Data	
9	RTN	Return	

PORT 2 (DB-25)

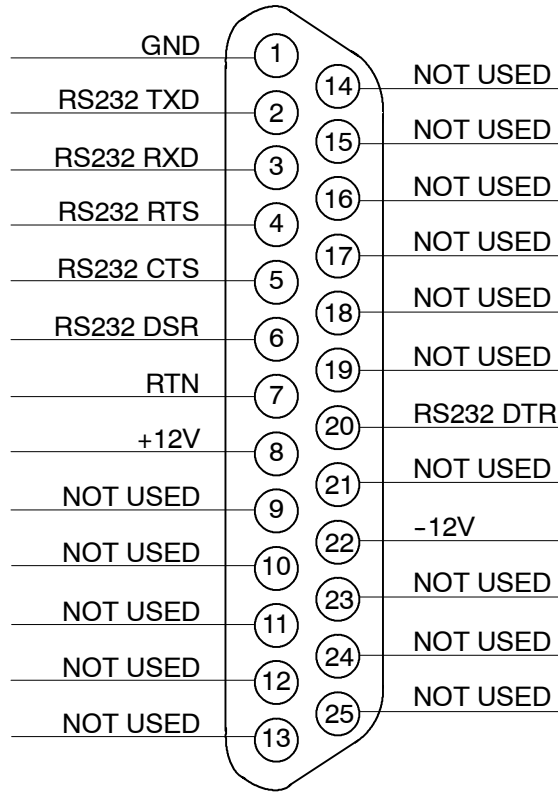

Figure 25. Port 2 Pin Assignments

Table 3. Pin Assignments for Port 2 (DB-25)			
Pin #	Symbol	Description	Comments
1	GND	Chassis Ground	
2	TXD	Transmit Data	Input to UPS
3	RXD	Receive Data	Output from UPS
4	RTS	Request to Send	Input to UPS
5	CTS	Clear to Send	Output from UPS
6	DSR	Data Set Ready	Output from UPS
7	RTN	Return	
8	+12V	+ 12 volts	Output from UPS – always true
20	DTR	Data Terminal Ready	Input to UPS – typically not used by UPS
22	-12V	- 12 volts	Output from UPS – always true
<i>NOTE: Pins 5 and 6 are tied together internally.</i>			

Configuring the Serial Ports

You must configure the port for communications using the LCD screen and pushbuttons on the UPS Monitor Panel.

Select **Port 1** or **Port 2** from the Setup menu to display one of the Setup Port screens. The screens for Port 1 and Port 2 are identical, and allow you to specify settings for the two serial communication ports. Figure 26 shows the Setup Serial Port 1 screen.

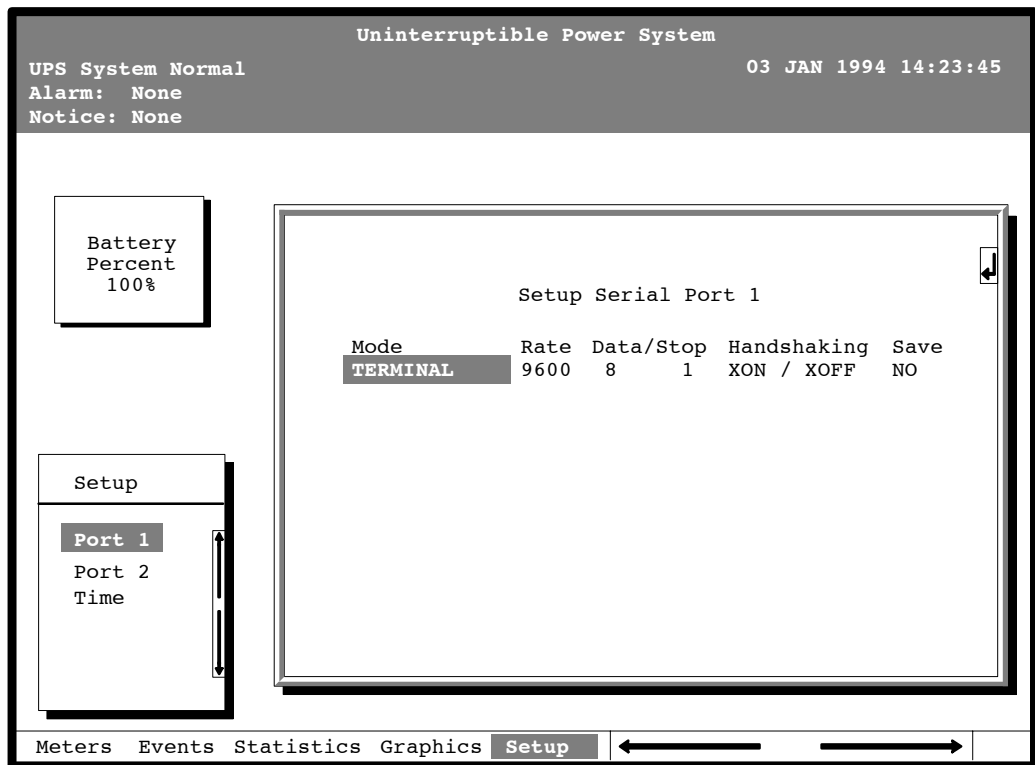

Figure 26. Setup Serial Port 1 Screen

A small return arrow (↵) appears in the upper right corner of the Setup Port screen. This arrow is a reminder that you can press the ↵ pushbutton on the Monitor Panel to toggle the pushbuttons between the menu box and the information area.

If the scroll bar is in the menu box, press the ↵ pushbutton to toggle to the information area. The first setting (Mode) is highlighted. Press the ← or → pushbutton to move the highlight to the setting you want to change. To scroll through the available options for that setting, press the ↑ or ↓ pushbutton.

To save the settings upon exit from this screen, be sure the Save field is set to YES.

Table 4 shows which options are available for each port. The sections that follow describe the configuration settings you can change.

Table 4. Options Available for Each Communication Port		
Port 1	Port 2	Options
X	X	Terminal Mode
		Calibration Mode
X	X	System Configuration
	X	Computer Mode
X		Remote Monitor Mode
X	X	Baud rate of 300, 1200, 2400, 4800, 9600, or 19,200
X	X	Data size/stop bits of 8/1 or 8/2
	X	Data size/stop bits of 7/1 or 7/2
X	X	Disabled handshaking
X	X	XON/XOFF handshaking

Mode

The operational mode of the port. Each communications port operates in one of the following modes:

- Terminal mode** System events are logged immediately as they occur.
- Calibration** Used only by service personnel.
- System Config.** Allows you to set building alarms, battery tests, etc. *(Check with your Sales or Service Representative for availability.)*
- Computer** Provides a proprietary Binary Computer Mode (BCM) Interface.
- Remote Monitor** Sends all system event information to an RMP, RIM, or Supervisory Contact Module (SCM). Available for Port 1 only.

Port 1 and Port 2 cannot be in the same mode simultaneously; they must always be operating in different modes. The modes are described later in this chapter.

Rate

The baud rate of the equipment connected to this port. The baud rate determines the speed of data transferred between the UPS and the connected equipment. For Remote Monitor mode, the baud rate must be set to 300. All other modes should operate at the highest baud rate available with the connected equipment. 300 baud is not recommended for any mode except Remote Monitor.

You can select a baud rate of 300, 1200, 2400, 4800, 9600, or 19,200.

Data/Stop

The data size and stop bits of the equipment connected to this port. These settings determine the number of bits transmitted per ASCII character. The data size and stop bits you specify depend on the configuration of your equipment.

For Port 1, the data size must be set to 8, with 1 or 2 stop bits. Settings of 7 data bits/1 stop bit and 7 data bits/2 stop bits are available for Port 2.

NOTE: *When connecting a computer running a terminal emulation program, you should set your equipment to NO PARITY.*

Handshaking

This setting controls handshaking. You can select XON/XOFF or Disabled for this setting.

Disabled (No Handshaking)

If handshaking is disabled, the UPS will transmit and receive data via the serial port, ignoring all inputs from handshaking lines.

XON/XOFF

If handshaking is enabled, the UPS uses special characters (XON and XOFF) to handshake with the host terminal. The XON character is defined to be ASCII value 11 hex, and the XOFF character is defined to be ASCII value 13 hex. Upon reception of an XOFF command, the UPS halts transmission until an XON command is received. In the same way, if the terminal receives an XOFF command, the UPS expects the terminal to halt transmission until the UPS sends an XON command.

Save

Set to YES to save any changes to configuration settings upon exit from the Setup screen. Set to NO if you do not want to save any changes.

Default Settings

The following are the default configuration settings for the serial communications ports:

Port 1 Remote Monitor 300 baud 8/1 Handshaking Disabled

Port 2 Terminal 9600 baud 8/1 Handshaking Disabled

Each communications port on the UPS operates in one of five modes which you select when configuring the port using the Setup Port screen.

Terminal Mode

In this mode, system events are continually logged through the serial port to the device connected to the port. Port 2 operates by default in Terminal mode.

The printed log entries contain a time and date stamp and the alarm text message. Terminal mode uses this format for printing alarm entries:

```
MMM DD HH:MM:SS.hh KYWD MESSAGE **** <CR> <LF>
```

<i>Symbol</i>	<i>Description</i>
MMM	Month (3 letters)
DD	Day (2 digits)
HH	Hour (2 digits)
MM	Minute (2 digits)
SS	Second (2 digits)
hh	Hundredths of Second (2 digits)
KYWD	Keyword (ALARM, NOTICE, COMMAND, or STATUS)
****	System Diagnostic Information
<CR>	Carriage Return Character (ASCII 13)
<LF>	Line Feed (ASCII 10)

An alarm message is prefixed by the word "CLEAR" whenever an alarm is entered into the Event History Log with a cleared status.

Printing Selected Information

If a port is operating in Terminal mode and is connected to a computer, you can use key combinations at any time to print only selected information:

Ctrl+P	Prints the entire log with a header
Ctrl+M	Prints the current system meters with a header
Ctrl+A	Prints all system information
Ctrl+B	Prints Battery Test Log

To use a key combination, hold down the Control key and press the letter key.

Entire Log (Ctrl + P)

This key sequence prints the entire Event History Log of the UPS at the time the data is requested. The printout begins with the oldest alarm entry in the queue and ends with the most recent. Any alarms that occur while the Event History Log is printing are included in chronological order.

The Event History Log lists up to 400 system events in chronological order with the most recent event listed last. Figure 27 shows a sample Event History Log printout.

```

                                Uninterruptible Power System

UPS System Normal                      03 JAN 1994 14:22:49
Alarm:  None
Notice: None

                                Event History Log

                                Event Description

MAY 12 16:41:19.3 COMMAND: Keyswitch On      0421
      12 16:41:29.1 STATUS:  Auto Mode        1000
      12 16:41:42.4 COMMAND: Rectifier Commanded On  2030
      12 16:42:05.5 STATUS:  Inverter On        2202
      12 16:42:46.8 STATUS:  Rectifier On
      12 16:43:15.8 STATUS:  Battery Contactor (K2) Closed
      12 16:43:42.4 STATUS:  Inverter Contactor (3) Closed
      12 16:44:29.1 STATUS:  Bypass Contactor (K4) Open  32
      12 16:44:36.6 STATUS:  Inverter Normal  4001

JUN 04 12:16:35.9 NOTICE:  Room High Temperature

```

Figure 27. Event History Log

Meters Printout (Ctrl + M)

This key sequence prints the current readings of the UPS system meters. The Input area shows the phase-to-phase voltage, frequency, and phase current of the incoming utility, followed by the kVA, kW, and power factor measurements. The output area shows the same information for the power being output by the UPS. The Bypass area shows the phase-to-phase voltage of the bypass source. The Battery area displays the DC voltage (V) and the DC current (I). Figure 28 shows a sample Meters printout.

Uninterruptible Power System							
UPS System Normal				03 JAN 1994 14:22:49			
Alarm: None							
Notice: None							
Input				Output			
VAB	VBC	VCA	FREQ	VAB	VBC	VCA	FREQ
480	480	480	60.0	208	208	208	60.0
IA	IB	IC		IA	IB	IC	IN
88	88	88		222	222	222	0
KVA	KW	PF		KVA	KW	PF	
73	69	0.95		80	64	0.80	
Bypass				Battery			
VAB	VBC	VCA		V	+	I	
480	480	480		540		0	

Figure 28. System Meters

System Information Printout (Ctrl + A)

This key sequence prints a listing of all available serial data. This printout contains the information shown on the Event History Log and Meters screens of the UPS (both Figures 27 and 28).

Battery Test Printout (Ctrl + B)

This key sequence prints the Battery Test Log. The log consists of a history of the last 30 battery tests that were run and the results of those tests. The most recent test will appear at the bottom of the log. Figure 29 shows a sample of the Battery Test Log.

```
Uninterruptible Power System
      UPS # 1
UPS System Normal           12 APR 95 15:39:31
Alarm:  None
Notice:  None

      Battery Test Log
Date/Time      Volts  Health  Data
AUG  14  23:45  498.0  1.00   0000
SEP  11  23:45  498.0  1.00   0000
OCT   9  23:45  498.0  1.00   0000
NOV  13  23:45  498.0  0.99   0000
DEC  11  23:45  498.0  0.99   0000
JAN   8  23:45  498.0  0.98   0000
FEB  12  23:45  498.0  0.98   0000
MAR  12  23:41  000.0  0.00   0003
APR   9  23:45  496.2  0.98   0000
```

Figure 29. Battery Test Log

The **Date/Time** field is the date and time of the battery test.

The **Volts** field is a measured value of the battery voltage during the test. This field will display 000.0 if the test did not run to completion.

The **Health** field is a relative measurement of your batteries condition. This number can be used to chart the condition of your batteries. If a sudden change of this number occurs relative to the previous test results, it is an indication that your batteries may need attention. This display is 0.00 if the test does not run to completion.

The **Data** field is a value to be used by your field service engineer to gain more information about the battery tests.

If the battery test does not complete, the Volts and Health field will read zero and the UPS Event History Log will report either Battery Test Failed, Battery Test Aborted (Load), or Battery Test Aborted (Utility). If the test ran to completion, Battery Passed Test will appear in the UPS Event History Log.

System Configuration

The System Configuration mode allows you to modify special functions in your UPS. These functions include programming of building alarms, customizing building alarm messages, adjusting the nominal output voltage, and scheduling battery tests. The menus provided and their function are described in this section.

System Configuration Mode Main Menu

When the System Configuration mode is selected with a terminal attached, you will be prompted to enter the password for this mode:

Please Enter Password:

The default password is EXIDE1. You may modify this password using the change password function in the following menu. When the valid password is entered, the main menu will be displayed:

Program Mode Main Menu

1. Program Building Alarms
2. Program Unit Name
3. Adjust Output Voltage
4. Change Password
5. Battery Test Setup
6. Modify Low Battery Time
7. Exit Program Mode

Enter Selection:

Program Building Alarms

This menu provides access to all the functions available in the system configuration mode. If 1 is entered at the prompt, you can program the building alarm functions:

Program Building Alarms

1. Enable/Disable Default Functions
2. Customize Alarm Messages
3. Return to Main Menu

Enter Selection:

Enable/Disable Default Functions

From this menu you may either enable the building alarms for general functions or special functions such as On Generator, Go To Bypass, and Go To UPS. You may also customize the alarm messages from this menu. When 1 is selected from this menu, the following menu is displayed:

Enable/Disable Default Functions

1. Enable/Disable Go To Bypass
2. Enable/Disable Go To UPS
3. Enable/Disable On Generator
4. Enable/Disable Building Alarm
5. Return to Program Building Alarms Menu

Enter Selection:

If you select entry 1–3 from this menu, the following menu will be displayed:

Enable/Disable (*Function*)

Enabled Building Alarm Number(s)

1 4

Enter E# to Enable Building Alarm Number #

Enter D# to Disable Building Alarm Number #

Enter <CR> for No Change

Enter Selection:

Where (*Function*) indicates the function the building alarm is being programmed for. The line following the Enabled Building Alarm Number(s) label indicates which building alarms are currently enabled for the function. (In this example, Building Alarms 1 and 4 are enabled.) A building alarm can only be programmed for one special function at a time from these menus. Enabling a building alarm for a special function automatically enables the alarm. If you disable a special function, the building alarm is also disabled.

If you select entry 4 from this menu, the following menu will be displayed:

Enable/Disable Building Alarm

Enabled Building Alarm Number(s)

1 4

Enter E# to Enable Building Alarm Number #

Enter D# to Disable Building Alarm Number #

Enter <CR> for No Change

Enter Selection:

The line following the Enabled Building Alarm Number(s) label indicates which building alarms are currently enabled. (In this example, Building Alarms 1 and 4 are enabled.)

Customize Alarm Messages

If Customize Alarm Messages is selected from the Program Building Alarm menu, you can select a custom message for a building alarm or disable a previously enabled building alarm custom message. When this entry is selected, the following menu is displayed:

```
Customize Alarm Messages
Enabled on Building Alarm Number(s)
2 3
```

Enter Building Alarm Number:

This example indicates that there are custom messages enabled for Building Alarms 2 and 3. When a building alarm number is entered, the message being used by the software is displayed (either a custom message or the default message indicated by the list of enabled custom messages). If 1 was entered at the prompt, the following will be displayed:

```
Building Alarm Active Message: Building Alarm 1 (default message)
```

```
Enter New Message or <CR> for No Change:
```

At this level you can enter a custom message, 30 characters maximum, to display when Building Alarm 1 is activated. If a custom message is entered to activate the building alarm, a custom message should also be entered to deactivate. After the message or a carriage return is entered, the following is displayed:

```
Building Alarm Clear Message: Clear Building Alarm 1 (default message)
```

```
Enter New Message or <CR> for No Change:
```

At this prompt, the user should enter the custom message for the building alarm deactivation state. When a message or a carriage return is entered, the following will be displayed:

```
Enter E to Enable Custom Message
```

```
Enter D to Disable Custom Message
```

```
Enter <CR> for No Change
```

```
Enter Selection:
```

If an E is entered at the prompt, the custom messages will be used for the building alarm. If a D is entered, the default messages will be used for the building alarm.

Program Unit Name

If Program Unit Name is selected from the main menu, the following is displayed:

```
Program Unit Name
```

```
Unit Name:
```

```
Enter New Name or <CR> No Change:
```

NOTE: Unit Name is 45 characters maximum

The current unit name is displayed. This name will be displayed on the second line of the display and in the headers of prints from Terminal mode. If a change is desired, the new unit name should be entered at the prompt. The unit name is 45 characters maximum and includes spaces and any punctuation. If the user wants to center the text portion of the name, the appropriate number of leading spaces should be included when entered.

Adjust Output Voltage

If Adjust Output Voltage is selected from the main menu, the following menu is displayed:

Adjust Output Voltage

Output Voltage Setup: 208

Output Voltage Range: 197 – 218

Enter Desired Output Voltage Setup:

The output voltage desired can then be entered or a carriage return for no change. Only values within the range will be accepted.

Change Password

If Change Password is selected from the main menu, the following menu is displayed:

Change Password

Enter New Password:

Verify New Password:

NOTE: Password must be six characters in length.

<CR> to return with no change.

The password will be changed if the user enters and verifies the password. The entry must be six characters.

Battery Test Setup

If Battery Test Setup is selected from the main menu, the following menu is displayed:

Battery Test Setup

1. Setup One-time Delayed Battery Test
2. Setup Monthly Battery Test
3. Setup Quarterly Battery Test
4. Cancel Pending Battery Test
5. Display Next Scheduled Battery Test
6. Return to Main Menu

Enter Selection:

This menu allows you to schedule, review schedule, or cancel pending battery tests. The following menu is displayed when 1–3 is selected:

Enter Starting Month (1–12):

Enter Day of Week, Sunday = 1, (1–7):

Enter Week of Month (1–5):

Enter Hour of Test (0–23):

Enter Minute of Test (0–59):

NOTE: Follow each entry with <CR>.

<CR> with no entry will return to Battery Test Setup Menu.

Enter the information at the prompt with a carriage return to schedule the battery test.

If entry 4 is selected from the Battery Test Setup menu, you will be prompted to enter “Y” to cancel all pending tests. This selection will only cancel pending tests and will not stop a test currently in progress.

If entry 5 is selected from the Battery Test Setup menu, and if a Battery Test is scheduled, the following menu is displayed:

Next Battery Test Scheduled

WK DAY MON HR:MN

4 FRI MAR 15:34

NOTE: Enter <CR> to return to Battery Test Setup Menu.

If 5 is selected and there are no tests scheduled, the following will be displayed:

No Battery Test Scheduled

Enter <CR> to return to Battery Test Setup Menu

NOTE: The unit will only perform one battery test in any 24 hour period.

Modify Low Battery Time

This menu allows you to modify the low battery time warning. When selected, the following menu will be displayed:

Modify Low Battery Time

Low Battery Time (Minutes): 004

Enter New Low Battery Time:

NOTE: *Low Battery Time should be no greater than 999. Enter <CR> to return with no change.*

Enter the new time desired to change the warning level.

Calibration Mode

Calibration mode is used by factory and field service personnel to calibrate system meters. Factory test engineers calibrate the UPS meters prior to shipping so the UPS arrives at your site correctly calibrated. After use, field service personnel may need to use Calibration mode to recalibrate one or more meter settings.

NOTE: *Calibration mode is for use by service personnel ONLY. To prevent inadvertent modification, this mode can be accessed only by trained personnel.*

Computer Mode

This mode provides a computer interface which gives your system compatibility with system monitoring and network products. For a list of products available, contact your sales representative.

Remote Monitor Mode

This mode provides the interface for the RMP, RIM, or SCM described earlier.

This Page Intentionally Left Blank.



Remote Notification provides the user with the option of receiving alarms and notices at a remote location. Remote Notification also provides some basic controls that can be performed remotely on the UPS. Remote Notification operates through a standard computer modem. Using the Terminal mode, the user calls the UPS to perform basic monitoring and control. In the event of a UPS alarm or notice, the user is notified at the remote location. The UPS calls, through the modem, to the user's computer or pager and leaves a message.

Remote Notification is an extension of the Terminal mode with the additional support algorithms necessary to control an external modem (refer to Chapter 7, "Serial Communications"). Connection to the UPS is made when a user calls the UPS on the phone. The user has exactly the same capabilities as if using a terminal connected directly to the UPS RS-232 port. Remote Notification differs from the basic Terminal mode with the addition of Call Answer, Call Out, and Housekeeping functions. The Call Answer function allows the user to call into the UPS from a remote location and enter Terminal mode. The Call Out function allows the UPS to be configured to call either a remote computer or numeric paging service over the phone line. Call Out allows the UPS to call a remote computer and leave a one-line descriptive message of the alarm or notice condition. Numeric paging support allows the UPS to call a paging service and send numeric messages. The Housekeeping function maintains the link between the UPS and modem.

Remote Notification Features

Remote Notification provides the UPS with the capability to utilize a standard off-the-shelf PC modem as a telephone interface. The features provided by this option are as follows:

- Call out to a remote terminal or pager based on programmable events and alarms.
- Two separate, programmable notification groups (phone numbers).
- Programmable number of redial attempts.
- Programmable time delay between call out attempts.
- Automatic answering (user configurable) for access to the Terminal mode of the UPS.
- Remote and local ability to clear Call Out alarms and events.
- Error detection and correction for misconfigured and disconnected modems.
- Uses standard modems and cables available at your local computer supply center.

Description of Operation

The Remote Notification option performs three basic functions: Call Answer into Terminal mode, Call Out to a remote terminal, and Housekeeping. Remote Notification also allows access to any functions available in the Terminal mode from a remote computer or terminal.

Call Answer

To use the Call Answer function, the modem is configured to automatically answer by having the user program the S0 register of the modem to a non-zero number. When the modem receives a call, the UPS is alerted to wait for a connect signal from the modem. When the modem answers and finishes handshaking, the UPS acknowledges the modem connect signal and allows the caller into the Terminal mode (refer to Chapter 7, “Serial Communications”). In this mode, the user can request four items and perform one command:

NOTE: *The brackets ([]) in the following steps indicate standard keyboard characters.*

- Display all screens (^B, ^M, ^P). Press and hold [CTRL], then press [A].
- Display battery test results by pressing and holding [CTRL], then pressing [B].
- Display meters screen by pressing and holding [CTRL], then pressing [M].
- Display event history by pressing and holding [CTRL], then pressing [P].
- Reset Call Out Alarms by pressing and holding [CTRL], then pressing [R].

The Reset Call Out Alarms command causes the UPS to cease Call Out attempts on a currently active alarm and resets that alarm call. Refer to the “Call Out” section of this chapter for more information.

Call Out

The Call Out function contains programmable alarms and status events (refer to Chapter 11, “Responding to System Events”). The notification groups tell the UPS to notify a remote computer or pager for each selected event. Refer to the “Configuring the Modem” section of this chapter for information on the modem configuration. Refer to the “User-Selected Events” section of this chapter to note which events are designated as group one or two. These events are selected when the UPS is purchased. The Call Out function activates as follows:

- A UPS alarm or notice occurs that is programmed to cause a Call Out.
- The UPS takes the modem off the hook and sends a command to the modem to call the notification groups (phone numbers) required. The command sent to the modem for group one is “ATDTS0” and “ATDTS1” for group two. This allows the user to program the phone numbers into the modem.

- The UPS logs a successful notify to the event log when the remote computer or modem answers and leaves an event message with the following format.

nnn<space>mmm<LF><CR> where:

nnn	=	The telephone number of the UPS (20 characters maximum)
<space>	=	ASCII space character (0x20)
mmm	=	Event message for notice or alarm (40 characters maximum)
<LF>	=	ASCII line feed character (0x0A)
<CR>	=	ASCII carriage return character (0x0D)

If calling a pager service and the service answers, the UPS delays momentarily and then dials the pager number. Refer to the “Configuring the Modem to Call a Numeric Pager” section of this chapter for more information on configuring a modem to dial a pager.

NOTE: *Because the pager service is not a modem, the UPS does not know if its message got through; therefore, the UPS continues to call the pager service for a programmed number of times or until a call-in reset is performed. An unsuccessful notify event is logged into the UPS event log for each attempted call out.*

If the phone number that the UPS is calling does not answer, the UPS delays for a time period (programmable from 1 to 60 minutes) and then reattempts the call. If answered, the UPS ceases further attempts to call. Each call group can be programmed for a separate number of attempts to call and delay between calls. Each unsuccessful attempt to call causes an unsuccessful notify event to be logged into the UPS event log.

If both call groups are active, the UPS alternates between calling the groups. The Call Out process can be terminated at any time by calling into the UPS and sending the reset command (press and hold [CTRL] and press [R]) or by turning the key switch on the front of the UPS.

Housekeeping

When the modem is idle, the UPS “pings” (tests for connection) the modem by sending an “AT” to the modem at five-minute intervals. If the modem does not respond correctly, by sending either “OK” or “0” to the UPS, the UPS attempts to re-initialize the modem. After a successful re-initialization, the UPS returns to the Housekeeping function. If the re-initialization is unsuccessful, two more attempts to re-initialize the modem are made before the UPS disables all Call Out attempts. Re-initialization is then attempted every ten minutes or until the communications mode is changed by the UPS front panel controls (or the modem re-initializes). For each unsuccessful attempt, the UPS logs a modem failure event into the event log. When the modem link is confirmed, the UPS communications resume normal operation and Call Out is enabled.

Hardware Requirements

The following hardware components are required to connect the Remote Notification function.

- Modem: Basic external PC modem supporting the following AT commands.
 - E0 – Do not echo characters in command state.
 - M0 – Turn speaker off.
 - N0 – Handshake only at speed specified by S37.
 - Q0 – Return result codes in both originate and answer mode.
 - V0 – Display result codes as numbers.
 - X0 – Provide basic result codes: CONNECT, NO CARRIER, and RING.
 - &A0 – Connect as answering modem when auto-answering.
 - &D0 – Ignore status of DTR signal.
 - &K0 – Disable local flow control.
 - &Q5 – Communicate in error control mode.

NOTE: Consult the modem manufacturer's manual to confirm that the above commands are supported by your modem.

- Standard serial cable with a male DB25 connector on both ends.
- DB25 null modem adapter.

All the above items can be acquired at your local computer products supply store.

An alternative to purchasing a cable is to build your own serial cable using the following pin out description:

Male DB25	Male DB25
pin 7	pin 7
pin 2	pin 2
pin 3	pin 2

Configuring the Modem

The modem must be configured by the user before connecting to the UPS. In addition, the modem must be programmed with the Call Out telephone numbers in order to operate the Remote Notification option.

To configure the modem, connect the serial port of a standard PC computer to the modem through the serial cable. Run a terminal emulation program on the computer. Test the connection to the modem by typing [A], [T] and [ENTER]. The modem should respond with either “OK” or “0” (zero). If the modem does not respond, consult the modem manufacturer’s manual to confirm your setup. If the modem still does not respond, then seek technical assistance from your modem manufacturer.

After connection, perform “Basic Modem Configuration” and the remaining sections of this chapter.

Basic Modem Configuration

The basic modem configuration consists of establishing the default operating parameters for the modem and saving them to the modem memory. This procedure sets up the modem for all operations. The configuration procedure is as follows:

1. Connect the modem to the PC through the serial port as described in the modem manufacturer’s manual.

NOTE: The brackets ([]) in the following steps indicate characters that require keying in prior to pressing [ENTER].

2. Key in [A], [T], then press [ENTER].
3. Confirm that the modem responds with “OK” or “0” (zero).
4. Key in [A], [T], [&], [F], then press [ENTER].
5. Confirm that the modem responds with “OK” or “0” (zero).
6. Key in [A], [T], [Q], [0] (zero), [V], [0] (zero), [M], [0] (zero), [N], [0] (zero), [X], [0] (zero), [&], [A], [0] (zero), [&], [D], [0] (zero), [&], [K], [0] (zero), [&], [Q], [5]. Verify that the display reads “ATQ0V0M0N0X0&A0&D0&K0&Q5”, then press [ENTER].
7. Confirm that the modem responds with “OK” or “0” (zero).
8. Key in [A], [T], [&], [W], [0] (zero), then press [ENTER].
9. Confirm that the modem responds with “OK” or “0” (zero).
10. Key in [A], [T], [&], [Y], [0] (zero), then press [ENTER].
11. Confirm that the modem responds with “OK” or “0” (zero).

Configuring the Modem to Call a Remote Computer

To configure the modem to call a remote computer, perform the following procedure:

NOTE: Perform this procedure only after completing “Basic Modem Configuration” section of this chapter.

The brackets ([]) in the following steps indicate characters that require keying in prior to pressing [ENTER].

1. Connect the modem to the PC through the serial port as described in the modem manufacturer’s manual .
2. Key in [A], [T], then press [ENTER].
3. Confirm that the modem responds with “OK” or “0” (zero).

NOTE: In steps 4 and 5, the “xxxxxx” is the phone number of a remote computer. The phone number should include all local line and long distance access numbers needed to dial out. This number is limited to 32 characters. Placing a “T” at the beginning of the number informs the modem to use tone dialing. For example, use “9” if needed for an outside line, “1” for long distance + (Area Code) + Number or whatever access codes are needed to dial the call directly. Add a “,” in the number anywhere that a delay is needed. This will cause a one-second delay. More than one delay may be added to the number; for example, enter “AT&Z0=T,9,,1 (Area Code) (Phone Number)”.

4. To program a group one number, key in [A], [T], [&], [Z], [0] (zero), [=], [T], [,], [xxxxxxx], then press [ENTER].
5. To program a group two number, key in [A], [T], [&], [Z], [1], [=], [T], [,], [xxxxxxx], then press [ENTER].
6. Confirm that the modem responds with “OK” or “0” (zero).
7. Key in [A], [T], [&], [W], [0] (zero), then press [ENTER].
8. Confirm that the modem responds with “OK” or “0” (zero).
9. Connect a telephone line to the modem and test the modem by keying in [A], [T], [D], [S], [0] (zero), then pressing [ENTER].
10. The modem dials the telephone number stored in step 4 or 5. (The number is displayed on the terminal screen as it is dialed.) Repeat steps 4 (or 5) through 9 as necessary to modify the telephone number.
11. Confirm that the modem responds with “1” (one) when the connection is made.

NOTE: To set up a group one or group two pager number, refer to “Configuring the Modem to Call a Numeric Pager” section of this chapter.

Configuring the Modem to Call a Numeric Pager

To configure the modem to call a numeric pager system, perform the following procedure.

NOTE: Perform this procedure only after completing “Basic Modem Configuration” section of this chapter.

The brackets ([]) in the following steps indicate characters that require keying in prior to pressing [ENTER].

1. Connect the modem to the PC through the serial port as described in the modem manufacturer’s manual .
2. Key in [A], [T], then press [ENTER].
3. Confirm that the modem responds with “OK” or “0” (zero).

NOTE: In steps 4 and 5 the “xxxxxx” is the pager system number and “yyyyyy” is the numeric message (usually a phone number). The three “[,]” provide a delay while the pager system computer answers. The “xxxxxx” entry should include all local line and long distance access numbers needed to dial out, as well as the pause necessary between dialing the pager service and sending the pager the numeric message. This number is limited to 32 characters. Placing a “T” at the beginning of the number informs the modem to use tone dialing. For example, use “9” if needed for an outside line, “1” for long distance + (Area Code) + Number or whatever access codes are needed to dial the call directly. Add a “,” in the number anywhere that a delay is needed. This causes a one-second delay. More than one delay may be added to the number; for example, enter “AT&Z0=T,9,,1 (Area Code) (Phone Number) (Pauses) (Numeric Message)”. For areas with pulse dialing, the “T” should be inserted before the numeric message to switch to tone dialing. The numeric message can only be delivered using tone dialing. Keying in the “#” (pound) character at the end of the numeric message is very important. It prevents the pager service from picking up on the modem hang-up commands and sending additional characters.

4. To program a group one number, key in [A], [T], [&], [Z], [0] (zero), [=], [T], [,], [xxxxxx], [,], [,], [,], [yyyyyy], [#], then press [ENTER].
5. To program a group two number, key in [A], [T], [&], [Z], [1], [=], [T], [,], [xxxxxx], [,], [,], [,], [yyyyyy], [#], then press [ENTER].
6. Confirm that the modem responds with “OK” or “0” (zero).
7. Key in [A], [T], [&], [W], [0] (zero), then press [ENTER].
8. Confirm that the modem responds with “OK” or “0” (zero).
9. Connect a telephone line to the modem and test the modem by keying in [A], [T], [D], [S], [0] (zero), then pressing [ENTER].
10. The modem dials the telephone number stored in step 4 or step 5. (The number is displayed on the terminal screen as it is dialed.) Confirm that the pager receives the message. Repeat steps 4 (or 5) through 9 as required to modify the telephone number and message.

NOTE: To set up a group one or group two number to call a computer, refer to “Configuring the Modem to Call a Remote Computer” section of this chapter.

Configuring the Modem to Answer Incoming Calls

To configure the modem to answer incoming calls, perform the following procedure.

NOTE: *Calling into the UPS does not present any type of security risk. There are no commands that can be executed via the call-in feature except those available to the Terminal mode.*

1. Connect the modem to the PC through the serial port as described in the modem manufacturer's manual .

NOTE: *The brackets ([]) in the following steps indicate characters that require keying in prior to pressing [ENTER].*

2. Key in [A], [T], then press [ENTER].
3. Confirm that the modem responds with "OK" or "0" (zero).
4. Key in [A], [T], [S], [0] (zero), [=], [2], then press [ENTER].
5. Confirm that the modem responds with "OK" or "0" (zero).
6. Key in [A], [T], [S], [0] (zero), [?], then press [ENTER].
7. Confirm that the modem responds with "OK" or "0" (zero) and a value of "002".
8. Connect a telephone line to the modem. Test the modem by using another PC equipped with a modem to dial the first modem.
9. Confirm that the UPS modem responds with "2" when the phone is ringing, and a "1" after the UPS modem has answered and the carrier has been detected.
10. Key in [A], [T], [&], [W], [0] (zero), then press [ENTER].
11. Confirm that the modem responds with "OK" or "0" (zero).

Final Modem Configuration

The final step in configuring the PC modem for use with the UPS is to turn off the echo feature of the modem. Perform the following procedure.

NOTE: The brackets ([]) in the following steps indicate characters that require keying in prior to pressing [ENTER].

1. Connect the modem to the PC as described in the modem manufacturer's manual.
2. Key in [A], [T], then press [ENTER].
3. Confirm that the modem responds with "OK" or "0" (zero).
4. Key in [A], [T], [E], [0] (zero), then press [ENTER].
5. Confirm that the modem responds with "OK" or "0" (zero).
6. Key in [A], [T], then press [ENTER].
7. Confirm that the modem responds with "OK" or "0" (zero) and that the "AT" is not echoed back to the terminal.
8. Key in [A], [T], [&], [W], [0] (zero), then press [ENTER].
9. Confirm that the modem responds with "OK" or "0" (zero).

UPS Setup Configuration

Connect the modem to the UPS by connecting one end of the serial cable to the UPS Port 2 DB–25F connector and the other to the modem (refer to Chapter 7, “Serial Communications”). If using a standard serial cable, a null modem adapter is required for the connection to the modem.

The Powerware 9315 UPS can only use serial Port 2, DB–25F, for the Remote Notification option. This connection is located in the serial communications panel at the base of the UPS cabinet, behind the front door.

The modem operates at only one baud rate because there is no handshaking between the modem and the UPS. Select the lowest common baud rate (less than or equal to 2400 baud) compatible with the capability of the UPS interface equipment. For example, if the computer only has a 2400 baud modem, then the UPS should be set for 2400 baud. Remember, the remote computer modem can always slow down to the UPS baud rate, e.g., a 14400 baud modem can run at 2400 baud, but a 2400 baud modem cannot run at 14400 baud.

Following the instructions in Chapter 5, “Using the Monitor Panel” and Chapter 7, “Serial Communications”, use the LCD screen and pushbuttons on the Monitor Panel to access the setup screen and configure Port 2 as follows.

NOTE: *The modem should be connected to the UPS as described in the modem manufacturer’s manual before configuring the UPS communications port.*

<MODE>	Remote Notify
<RATE>	The baud rate at which the modem will communicate to other modems, 2400 baud maximum.
<DATA/STOP>	8 1 Standard 8 data bits, 1 stop bit, no parity.
<HANDSHAKING>	Disabled
<SAVE>	Yes. To save new configuration.

The handshaking feature listed is for UPS-to-terminal handshaking, not UPS-to-modem handshaking. Setting the handshaking to “modem” has no effect. If the remote terminal has buffering problems because of excessive data transfer rate from the UPS, XON/XOFF handshaking can be selected to resolve this issue. The user must make sure that the modem (not the remote terminal) at the remote terminal end of the connection is configured for either hardware handshaking or none at all. This is required so that the modem does not attempt to trap the XON/XOFF characters and prevent them from being transmitted to the UPS.

User-Selected Events

Insert a check at each alarm or notice in the appropriate Group 1 or Group 2 block to indicate the configuration of your UPS.

INVERTER MESSAGES – ALARMS	Group 1	Group 2	INVERTER MESSAGES – NOTICES	Group 1	Group 2
Inverter AC Over Voltage			Inv. Logic Power Failed		
Inverter AC Under Voltage			Bypass AC Over Voltage		
Inverter Calibration Required			Bypass AC Under Voltage		
Inverter Contactor (K3) Failed			Bypass is Not Available		
Inverter DC Over Voltage			Bypass Mode		
Inverter Failure			Bypass Over Frequency		
Inverter Over Frequency			Bypass Under Frequency		
Inverter Phase Rotation			Input Breaker (CB1) Open		
Inverter Setup Required			Battery Contactor (K2) Open		
Inverter Under Frequency			Battery DC Under Voltage		
100% Overload Shutdown			Battery Discharged		
125% Overload Shutdown			Battery Not Charged		
Over Temperature Shutdown			Battery Voltage Low		
Shutdown Imminent			Phase A Current Limit		
Load Off			Phase B Current Limit		
Bypass Contactor (K4) Failed			Phase C Current Limit		
Bypass Control Failed					
Bypass Phase Rotation					
Go To Bypass Active					
Battery Contactor (K2) Failed					
Battery Ground Fault					

RECTIFIER MESSAGES – ALARMS	Group 1	Group 2	RECTIFIER MESSAGES – NOTICES	Group 1	Group 2
Input Phase Rotation			Battery Test Failed		
Over Temperature			DC Voltage High		
Over Temperature Warning			DC Voltage Low		
Rectifier Calibration Required			Equalizing Battery		
Rectifier DC Over Voltage			Input AC Over Voltage		
Rectifier DC Under Voltage			Input AC Under Voltage		
Rectifier Failure			Input Over Frequency		
Rectifier Setup Required			Input Transient		
Temperature Sensor Failure			Input Under Frequency		
			Input/Battery Current Limit		
			Logic Power Failed		
			Power Supply Over Voltage		
			Power Supply Under Voltage		
			Rectifier 1.12		
			Reduced Input Current Limit		
			Testing Battery		

MONITOR MESSAGES – ALARMS	Group 1	Group 2	MONITOR MESSAGES – NOTICES	Group 1	Group 2
Battery Test Failed			Battery Passed Test		
Battery Test Failed			Battery Test Aborted (load)		
Fan Failure			Battery Test Aborted (utility)		
Load Over 100%			Battery Test Requires Calibration		
Load Over 125%			Battery Time Low		
Monitor Calibration Required			Building Alarm 1 Active		
Monitor Setup Required			Building Alarm 2 Active		
Overload Warning			Building Alarm 3 Active		
Power Supply Failure			Building Alarm 4 Active		
			Building Alarm 5 Active		
			Building Alarm 6 Active		
			Inverter Network Down		
			Monitor Logic Pwr Fail		
			Monitor Network Down		
			No Active Events		
			Output AC Over Voltage		
			Output AC Under Voltage		
			Output Over Frequency		
			Output Under Frequency		
			Power Off Switch		
			Rectifier Network Down		
			Testing Battery		
			Three Wire AC Over Voltage		
			Three Wire AC Under Voltage		
			Three Wire Over Freq.		
			Three Wire Under Freq.		

9

Maintaining the UPS System

The components inside the UPS cabinet are secured to a sturdy metal frame that is supported by the UPS magnetics. This design allows authorized service personnel to remove repairable components with very little disassembly. All repairable parts and assemblies are located in the front of the UPS, allowing all routine maintenance and servicing to be performed with front panel access.

You must schedule periodic performance checks of your UPS to keep it running properly. Regular routine checks of operation and system parameters will enable your UPS system to function efficiently for many trouble-free years.

Important Safety Instructions

Remember that your UPS is designed to supply power **EVEN WHEN DISCONNECTED FROM THE UTILITY POWER**. The UPS interior is unsafe until the DC power source is disconnected and the electrolytic capacitors are discharged. After disconnecting the utility power and the DC power, authorized service personnel should wait at least 5 minutes before attempting internal access to the UPS system.

WARNING:
LETHAL VOLTAGE PRESENT. This unit should not be operated with the cabinet doors open or protective panels removed. Do not make any assumptions about the electrical state of any cabinet in the UPS system.

WARNING:
Battery cabinet maintenance or battery replacement should be performed by authorized service personnel only. Keep unauthorized personnel away from battery cabinets.

Since each battery cabinet is an energy source in itself, opening the Battery Circuit Breaker does not de-energize the voltage within the battery cabinet. **DO NOT ATTEMPT TO ACCESS ANY INTERNAL AREA OF THE BATTERY CABINET YOURSELF. VOLTAGES ARE ALWAYS PRESENT IN THE BATTERY CABINET.** If you suspect that a battery cabinet needs service, you should contact your local field service office.

If the cabinet requiring service was not provided by the UPS manufacturer, refer to the battery cabinet manufacturer's operating manual for instructions on battery cabinet installation and maintenance, or contact your local field service office.

Observe these precautions when working on or around battery cabinets:

- Remove watches, rings, or other metal objects.
- Use tools with insulated handles.
- Wear rubber gloves and boots.
- Do not lay tools or metal parts on top of batteries or battery cabinets.
- Disconnect the charging source prior to connecting or disconnecting terminals.
- Determine if the battery is inadvertently grounded. If it is, remove the source of the ground. Contact with any part of a grounded battery can result in electrical shock. The likelihood of such shock will be reduced if such grounds are removed during installation and maintenance.
- When replacing batteries, use the same number of sealed, lead-acid batteries.
- Proper disposal of batteries is required. Refer to your local codes for disposal requirements.

WARNING:
HAZARDOUS WASTE. Do not incinerate or dispose of batteries indiscriminately. Observe local and national codes.

WARNING:
Do not dispose of battery or batteries in a fire. The battery may explode.

Do not open or mutilate the battery or batteries. Released electrolyte is harmful to the skin and eyes, and may be toxic.

A battery can cause electrical shock, burn from high short-circuit current, or fire. Observe proper precautions.

ATTENTION:
Une batterie peut présenter un risque de choc électrique, de brûlure, ou d'incendie. Suivre les précautions qui s'imposent.

- Pour le remplacement, utiliser le même nombre et modèle des batteries.
- L'élimination des batteries est réglementée. Consulter les codes locaux à cet effet.



Performing Preventive Maintenance

The UPS requires very little preventive maintenance. However, the UPS should be inspected periodically to verify that the unit is operating normally and that the batteries are in good condition.

Perform the following checks DAILY:

- Check the area surrounding the UPS. Ensure the area is not cluttered, allowing free access to the unit.
- Ensure the air intakes (vents on the front doors) and exhaust opening (on top of the UPS cabinet) are not blocked.
- Ensure there is at least six inches of clearance behind the unit for proper air circulation.
- Ensure the operating environment is within the parameters specified in Chapter 10, "Product Specifications."
- Ensure the UPS is in Normal mode (Normal status indicator is lit). If an alarm lamp is lit or the Normal status indicator is not lit, contact Customer Support.

Perform the following checks MONTHLY:

- Ensure all status indicator lamps are operative. (Press the  and  pushbuttons simultaneously to test the lamps.)
- Monitor system parameters as described in Chapter 5, "Using the Monitor Panel."
- Check the air filters (located behind the front doors) and replace them as necessary. The filter size is 16 in. x 20 in. x 1 in.
- Record the results of your checks and any corrective actions in a suitable log.

ANNUAL maintenance:

Annual preventive maintenance should be performed only by authorized service personnel familiar with maintenance and servicing of the UPS system. Contact your nearest field service office for more information about service offerings.

BATTERY maintenance:

Contact your nearest field service office for battery maintenance. Battery replacement and maintenance should be performed only by authorized service personnel.

Maintenance Training

A basic training course, available from Powerware Corporation, gives you a competent working knowledge of UPS operation and teaches you how to perform first level corrective maintenance. For more information about training and other services, contact the Powerware Training Coordinator in Raleigh, North Carolina, or call Powerware Corporation field service at **1-800-843-9433**.

This Page Intentionally Left Blank.

10

Product Specifications

The UPS systems are housed in freestanding, double-front cabinets with safety shields behind the doors. The UPS systems are available in both 50 Hz and 60 Hz, with various output power ratings. Smaller models within a system may be upgraded in the field to larger models:

System	Models	Notes
Powerware® 9315 40	40 kVA & 30 kVA	50 Hz or 60 Hz (400V models only)
Powerware® 9315 50	50 kVA, 40 kVA & 30 kVA	60 Hz only
Powerware® 9315 65	65 kVA & 50 kVA	50 Hz or 60 Hz (400V models only)
Powerware® 9315 80	80 kVA, 65 kVA & 50 kVA	50 Hz or 60 Hz models
Powerware® 9315 125	100 kVA & 125 kVA	50 Hz or 60 Hz (400V models only)
Powerware® 9315 130	100 kVA & 130 kVA	50 Hz or 60 Hz (400V models only)
Powerware® 9315 150	100 kVA, 125 kVA & 150 kVA	50 Hz or 60 Hz models
Powerware® 9315 160	100 kVA, 130 kVA & 160 kVA	50 Hz or 60 Hz models

The following sections detail the input, output, environmental, and battery specifications for the UPS.

System Input

Operating Input Voltage	400 VAC for operation from 340 VAC to 440 VAC (50/60 Hz) 208 VAC for operation from 177 VAC to 229 VAC (60 Hz only) 220 VAC for operation from 187 VAC to 242 VAC (60 Hz only) 480 VAC for operation from 408 VAC to 528 VAC (60 Hz only) 400 VAC for operation from 340 VAC to 440 VAC (60 Hz only) 600 VAC for operation from 510 VAC to 600 VAC (60 Hz only)
Operating Input Frequency Range	± 3 Hz of nominal (50 Hz or 60 Hz)
Operating Input Current	<u>Battery Charge:</u> 125% of full load for overload + battery charge Actual load + 25% of full load for battery charge <u>Reduced for Generator:</u> Adjustable, set to 102%
Input Current Harmonic Content	10% maximum over zero to full load based on 10% THD at full load (with input filter option installed)
Power Walk-In	Typically 15–20 second rectifier ramp-up to full utility load
Power Factor	Minimum 0.9
Line Surges	6 kV OC, 3 kA SC per ANSI 62.41 and IEC 801–4

System Output

Rectifier/Charger Capacity	115% for 160 kVA models 125% for 100–150 kVA models
DC Filtering	Ripple voltage less than 0.5% peak to peak
UPS Output Capacity	100% current at 0.8 power factor
Output Voltage Regulation	1% (10% to 100% load)
Output Voltage Adjustment	400 VAC nominal, adjustable from 375 VAC to 420 VAC (50/60 Hz) 208 VAC nominal, adjustable from 196 VAC to 220 VAC (60 Hz only) 220 VAC nominal, adjustable from 208 VAC to 232 VAC (60 Hz only) 480 VAC nominal, adjustable from 452 VAC to 508 VAC (60 Hz only) 600 VAC nominal, adjustable from 570 VAC to 630 VAC (60 Hz only) 400 VAC nominal, adjustable from 395 VAC to 420 VAC (60 Hz only)
Output Voltage Harmonic Content	3% max THD, 2% max single (for linear load)
Output Voltage Balance	2% for 100% maximum load imbalance
Output Voltage Phase Displacement	2° for 100% maximum load imbalance
Output Transients	± 5% for 100% load step or removal
Frequency Regulation	± 0.005 Hz free running
Synchronous to Bypass	Bypass within voltage limits of +5%, –8% of output setting; bypass within ± 0.5 Hz
Frequency Slew Rate	1 Hz per second maximum
Overload Capability	125% for 10 minutes 150% for 10 seconds 1000% for 10 cycles with bypass
Maximum Output Capability	300% peak for 10 cycles without bypass

Environmental Specifications

Operating Temperature	0 to 40°C without derating. However, operating at or near 40°C will adversely affect battery life (refer to your battery specifications for more information). The recommended operating temperature is 25°C.
Operating Altitude	Maximum 1500m (5000 ft) at 40°C without derating
Storage Temperature	-20 to +70°C (prolonged storage above 40°C will cause rapid battery self-discharge)
Relative Humidity (operating and storage)	95% maximum noncondensing
Acoustical Noise	65 dBA at a 1m distance
EMI Supression	Meets FCC Part 15, Subpart J, for class A devices
Electrostatic Discharge (ESD) Immunity	Meets IEC 801-2 specifications. Withstands up to 25 kV without damage and with no disturbance or adverse effect to the critical load.
System Efficiency at Full Unity Power Factor Load and Nominal Input Voltage	<p><u>400V, 600V Models:</u> Note: The 208 systems use an input auto transformer option that reduces system efficiency by 1% to 2%. The optional input isolation transformer option reduces system efficiency by 3%.</p> <p><u>480V Models:</u> 92%</p>

Battery Specifications

These specifications are for batteries supplied by the UPS manufacturer in line-up-and-match cabinets:

Battery Type	Sealed, maintenance-free, high rate discharge, lead-acid cells
Nominal Battery String Voltage	480 VDC (240 cells) for Powerware® 9315 50, 80, 150, 160 420 VDC (210 cells) for Powerware® 9315 40, 65, 125, 130
Float Charging	2.25 VDC per cell (540 VDC based on 240 cells) (420 VDC based on 210 cells)
Equalizing Charge	2.35 VDC per cell, set to 2.25 VDC at factory
Battery Charge Current Limit	Limited to 25% of full, regardless of actual load on inverter

This Page Intentionally Left Blank.

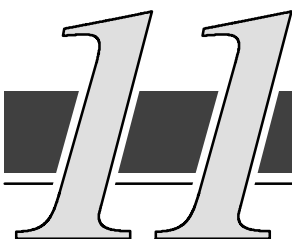

Responding to System Events

When the UPS system is running in Normal mode, it continually monitors itself and the incoming utility power. In Battery or Bypass modes, the UPS may issue alarms to let you know exactly what event caused the change from Normal mode. System events can be indicated by horns, lights on the UPS, or both.

Select **Active** from the Events menu on the LCD screen to look at the Active System Events screen. This screen shows any currently active alarms, notices, or commands.

System Event Horns

The system event horn beeps according to the type of event it is signifying:

- When the UPS detects an alarm that requires your attention, the horn beeps at 1/2-second intervals.
- When a notice occurs, the horn beeps at 2-second intervals.
- If the battery contactor is open and the Bypass mode is unavailable, the horn beeps every 4 seconds.

System Event Lights

The status indicators on the UPS Monitor Panel work in conjunction with the event horn to let you know when the UPS is operating in any mode other than Normal. Only the Normal indicator is visible during normal UPS operation. The others light to indicate alarms or events. When an alarm occurs, you should first check these indicators to see what type of event has taken place. (For descriptions of the status indicators, refer to the “Reading the Status Indicators” section of Chapter 5.)

System Event Messages

When a system event occurs, a message is added to the Event History Log. A message may also appear on the Monitor Panel of the UPS. The Event History Log contains all system event messages, whether or not they were displayed on the Monitor Panel.

INVERTER MESSAGES – ALARMS	INVERTER MESSAGES – NOTICES
Inverter DC Over Voltage Clear Inverter DC Over Voltage	Bypass AC Over Voltage Clear Bypass AC Over Voltage
Inverter AC Over Voltage Clear Inverter AC Over Voltage	Bypass AC Under Voltage Clear Bypass AC Under Voltage
Inverter AC Under Voltage Clear Inverter AC Under Voltage	Bypass Over Frequency Clear Bypass Over Frequency
Inverter Over Frequency Clear Inverter Over Frequency	Bypass Under Frequency Clear Bypass Under Frequency
Inverter Under Frequency Clear Inverter Under Frequency	Battery DC Under Voltage Clear Battery DC Under Voltage
Over Temperature Shutdown	Battery Not Charged Clear Battery Not Charged
100% Overload Shutdown	Bypass is Not Available Bypass is Available
125% Overload Shutdown	Input Breaker Open
Battery Cont. (K2) Failure	Inv. Logic Power Failure Clear Inv. Logic Pwr Fail.
Bypass Cont. (K4) Failure	Phase A Current Limit Phase B Current Limit Phase C Current Limit
Bypass Control Failure	Load Transferred to Bypass
Inverter Cont. (K3) Failure	
Inverter Failure	
Load Off	
Inverter Cont. (K3) Open	
Bypass Cont. (K4) Failure	

INVERTER MESSAGES -- COMMANDS	INVERTER STATUS MESSAGES
Bypass Mode Normal Mode	Inverter On Inverter Off
Keyswitch On	Battery Contactor (K2) Closed Battery Contactor (K2) Opened
Inverter Commanded On Inverter Commanded Off	Total Battery Discharge
	Bypass Contactor (K4) Closed Bypass Contactor (K4) Opened
	Input Breaker (CB1) Closed Input Breaker (CB1) Opened
	Inverter Contactor (K3) Closed Inverter Contactor (K3) Opened
	Inverter Shutdown
	Inverter Normal
	Load Transferred to Bypass
	Auto Mode

RECTIFIER MESSAGES -- ALARMS	RECTIFIER MESSAGES -- NOTICES
Rectifier DC Over Voltage Clear Rectifier DC Over Voltage	Input AC Over Voltage Clear Input AC Over Voltage
Rectifier DC Under Voltage Clear Rectifier DC Under Voltage	Input AC Under Voltage Clear Input AC Under Voltage
Rectifier Over Temperature Clear Rectifier Over Temperature	Input AC Over Frequency Clear Input AC Over Frequency
Rct. Over Temperature Warning Clear Rct. Over Temp. Warning	Input AC Under Frequency Clear Input AC Under Frequency
Rct. Temp. Sensor Failure Clear Rct. Temp. Sensor Failure	Rct. Logic Pwr Supply OV Clear Rct. Logic Pwr Sply OV
Rectifier Failure	Rct. Logic Pwr Supply UV Clear Rct. Logic Pwr Sply UV
Rectifier Alarm	Rectifier DC Too Low
	Input Voltage Transient
	Rct. Logic Pwr Fail. Clear Rct. Logic Pwr Fail.
	Battery Current Limit Clear Battery Current Limit
	DC Too High

RECTIFIER MESSAGES -- COMMANDS	RECTIFIER STATUS MESSAGES
Rectifier Commanded On Rectifier Commanded Off	Rectifier On Rectifier Off
	Rectifier Shutdown

MONITOR PANEL ALARMS	MONITOR PANEL NOTICES
Load Over 100% Clear Load Over 100%	Output AC Over Voltage Clear Output AC Over Voltage
Overload 100% Clear Overload 100%	Output AC Under Voltage Clear Output AC Under Voltage
Overload 125% Clear Overload 125%	Output Over Freq. Clear Output Over Freq.
Power Supply Failure Clear Power Supply Fail.	Output Under Frequency Clear Output Under Frequency
Fan Failure Clear Fan Failure	3W AC Over Voltage Clear 3W AC Over Voltage
	3W AC Under Voltage Clear 3W AC Under Voltage
	3W Over Frequency Clear 3W Over Frequency
	3W Under Frequency Clear 3W Under Frequency
	Power Fail Clear Power Fail
	Power Off Switch
	Building Alarm 1 Clear Building Alarm 1
	Building Alarm 2 Clear Building Alarm 2
	Building Alarm 3 Clear Building Alarm 3
	Building Alarm 4 Clear Building Alarm 4
	Building Alarm 5 Clear Building Alarm 5
	Building Alarm 6 Clear Building Alarm 6
	Rectifier Network Down Rectifier Network Clear
	Inverter Network Down Inverter Network Clear
	Monitor Network Down Monitor Network Clear

12 Using the **LOAD OFF** Pushbutton

Load Off is initiated by the covered, red **LOAD OFF** pushbutton on the Monitor Panel. This pushbutton is protected by a clear plastic shield to prevent accidental activation. In an emergency, you can press this pushbutton to instantaneously open the input breaker and interrupt UPS output. The UPS is cut off from utility power, and your critical load is de-energized. All power to the critical load is lost. The UPS (including Bypass) remains locked off until you reset the **LOAD OFF** pushbutton.

WARNING:

All power to the critical load is lost when you press this pushbutton. You should use this feature only in an emergency or when you want to de-energize the critical load.

To restart the UPS after pressing the **LOAD OFF** pushbutton, follow the procedure “Resetting the UPS System after Load Off” of this chapter before starting the UPS.

NOTE: *The Remote Emergency Load Off option functions the same way as the **LOAD OFF** pushbutton on the Monitor Panel.*

To Use the **LOAD OFF** Pushbutton:

1. Raise the clear plastic shield covering the red **LOAD OFF** pushbutton on the Monitor Panel.
2. Press the **LOAD OFF** pushbutton.
The breaker and contactors open (you can hear them opening). The **CB1** switch trips, and the Load Off **PUSH TO RESET** pushbutton on the UPS Control Panel pops out. The UPS system shuts down.

Resetting the UPS System after Load Off

CAUTION:

Do not attempt to restart the system after Load Off until the cause of the emergency has been identified and cleared.

The Load Off **PUSH TO RESET** pushbutton is a small white button on the UPS Control Panel. The **PUSH TO RESET** pushbutton pops out and the **CB1** switch trips when the **LOAD OFF** pushbutton on the Monitor Panel is activated.

To reset the UPS system:

1. Press the Load Off **PUSH TO RESET** pushbutton until it clicks in and remains recessed.
2. Move the **CB1** switch from the center (tripped) position to **OFF**. The switch should be difficult to move from the **TRIPPED** position.
3. The UPS system is now reset. To restart the UPS system, follow the procedure in Chapter 4, “Starting and Stopping the UPS.”

This Page Intentionally Left Blank.