



ИБП Eaton 9130 Marine 1kVA - Eaton 9130M UPS (1000-3000 VA) - Листовка описания и специфика

Постоянная ссылка на страницу: <https://eaton-power.ru/catalog/eaton-9130-marine/eaton-9130-marine-1kva/>

Eaton 9130M UPS

1000/2000/3000 VA



Multilingual LCD

Advanced vessel or rig power protection for:

- Bridge systems
- Navigation systems
- Communication systems
- Small computer and automation systems



Double conversion UPS

Qualified design for marine and offshore environment

- DNV and ABS type approved UPS
- Hardened mechanical design
- Easy to install, mounting rails can be bolted or welded to the deck/bulk head or shelf
- Vibration absorbers under the cabinet

Maximum availability

- Double conversion on-line UPS with automatic by-pass and power factor correction
- Possibility to add more runtime at any time with up to four external hot-swappable battery modules to run systems for hours if necessary.
- Enables prolonged runtime of essential equipment during power outages by allowing for orderly, remote shutdown of non-critical systems and processes thanks to a capability to control load segments.
- Continuous power supply: Batteries can be swapped without ever having to shut down connected equipment.
- Internal automatic static bypass switch
- ABM® technology charges batteries only when necessary, preventing batteries corrosion and prolonging batteries service life by up to 50%.

Outstanding versatility

- Format: Compact tower format design allows installation on the deck or on shelf
- Enhanced configuration capability through easily navigated multilingual graphical display.
- Adapted for use in the ungrounded electrical distribution systems (IT mains)
- Compatible with high power factor loads: Eaton 9130M is rated for 0.9 power factor (1000 VA/900 W, 2000 VA/1800 W and 3000 VA/2700 W)
- Configurable to frequency converter operation (50 → 60Hz and 60 → 50Hz)
- Connectivity options are available for almost any network environment.



Powering Business Worldwide

Eaton 9130M UPS



1. Multilingual graphical LCD display
2. Panel for replacing batteries
3. 1 USB port + 1 serial port
4. 1 Relay Output + 1 EPO connector
5. EBM battery unit connector
6. Load segments
7. Communication card slot

TECHNICAL SPECIFICATIONS

General	
User interface	Graphical LCD with blue backlight and text in English, French, German, Russian and Spanish
LEDs	Four status-indicating LEDs
Topology	True online, double-conversion
Diagnostics	Full system self-test
UPS bypass	Automatic bypass
Electrical Input	
Nominal voltage	220–240V
Voltage range	up to 120-276 VAC (depending on load level)
Frequency range	40-70 Hz (50/60 Hz)
Electrical Output	
Power factor	0.9
Voltage	±3 % of nominal regulation (on utility and battery)
Frequency regulation	±3 Hz online
Load crest factor	3 to 1

Communications	
Ports	RS-232 and USB HID port as standard
Relay output	Common alarm standard
Optional communication cards (BD Slot)	SNMP/Web card for monitoring in SNMP-based networks, monitoring through Web browser interface. Relay card for integration to industrial environment and BMS, remote shutdown for IBM AS/400 systems
Environmental	
Audible noise	<50 dB
Ambient operating	0°C to +40°C
Storage temperature	-20°C to +40°C with batteries and -25°C to +55°C without batteries
Relative humidity	5–90% non-condensing
Compliance with standards	
Safety	IEC/EN 62 040-1-1
Performance	IEC/EN 62 040-3
EMC	IEC/EN62040-2, (Emissions, Category C1; Immunity, Category C2), IEC/EN 60945
Approvals	CE, GS, DNV, ABS

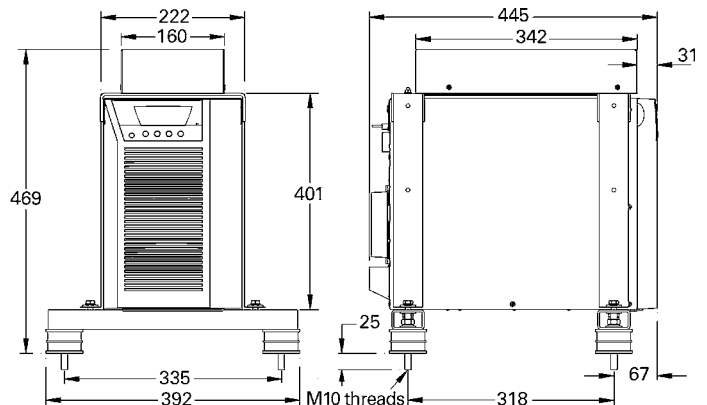
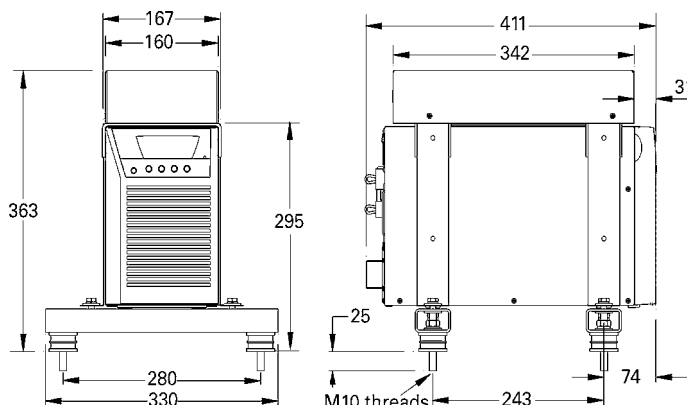

Description	Part number	Dimensions HxWxD*	Weight*
Eaton 9130 1kVA Marine	103007846-6591	363x330x411 mm	20 kg
Eaton 9130 2kVA Marine	103007847-6591	469x392x445 mm	33 kg
Eaton 9130 3kVA Marine	103007848-6591	469x392x445 mm	33 kg

* with Installation kit and filter assembled

Options	Part number
9130-1kVA Marine filter	1029424
9130-2kVA Marine filter	1031246
9130-3kVA Marine filter	1029425
9130-1kVA Installation kit	1029426
9130-3kVA Installation kit	1029427
PW9130N1000T-EBM	103006438-6591
PW9130N3000T-EBM	103006440-6591
2m EBM Cable for 1kVA	152602868-001
2m EBM Cable for 2-3kVA	152602870-001
Marine UPS requires Installation kit for DNV and ABS approval and Marine filter (EMC) for IEC/EN 60945 compliance	

BATTERY RUNTIMES*	Internal batteries		+1 EBM		+2 EBMs		+3 EBMs		+4 EBMs	
	100% Load	50% Load	100% Load	50% Load	100% Load	50% Load	100% Load	50% Load	100% Load	50% Load
Eaton 9130 1000 Marine	6	19	31	68	51	111	82	192	100	246
Eaton 9130 2000 Marine	11	27	44	95	79	168	115	258	161	336
Eaton 9130 3000 Marine	6	15	21	60	51	100	66	169	93	215

* Runtimes are shown at a 0.9 power factor. Backup times are approximate and may vary with equipment, configuration, battery age, temperature, etc.

www.eaton.com/powerquality/marine

