



ИБП Eaton 9155 Marine 10 kVA - Eaton 9155 Marine and 9355 Marine UPS 8-15 kVA - Листовка

Постоянная ссылка на страницу: <https://eaton-power.ru/catalog/eaton-9155-marine/eaton-9155-marine-10-kva>

Eaton 9155M and 9355M UPS

8 - 15 kVA



Advanced vessel or rig power protection for:

- Navigation systems
- Communication systems
- Ship automation
- Computer systems
- Integrated bridge

EATON

Powering Business Worldwide

Double conversion UPS

Qualified design for marine and offshore environment

- DNV type approved UPS
- BV type approved UPS
- ABS design assessed
- Compact design for saving space
- Easy to install, mounting rails can be bolted or welded to the deck/bulk head
- IP22 protection class
- Vibration absorbers under and at the back of the cabinet
- Maintenance from the front

Premium power performance

- Double conversion provides the highest level of protection available by isolating the output power from all input anomalies.
- Active power factor correction (PFC) provides 0,99 input power factor and less than 4,5% ITHD, thus eliminating interference with other critical equipment in the same network and enhancing compatibility with generators.
- The UPS is optimized for protecting modern 0,9 p.f. rated IT equipment without the need to oversize.

True reliability

- Patented Powerware HotSync® technology makes it possible to parallel up to four UPSs to increase availability or add capacity. The technology enables load sharing without any communication line, thus eliminating single point of failure.
- ABM® technology charges batteries only when necessary, preventing batteries corrosion and prolonging batteries service life by up to 50%.
- Internal automatic static bypass switch
- Internal mechanical bypass switch

Extensive configurability

- Configurable to frequency converter operation (50 → 60Hz and 60 → 50Hz)
- A multilingual graphical LCD display makes possible to monitor the UPS status easily.
- Wide software and connectivity options provide monitoring, management and shutdown capabilities over network.

Cost savings and sustainability

- Small footprint saves valuable space in ship and rig installations.
- Possibility for internal transformer or batteries eliminate the need for costly and space-consuming external cabinets.
- A single technical platform used in Eaton's UPS products guarantee easy upgrades and similarity in service, thus lowering total cost of ownership.
- A range of service agreement options can be easily customized for customers' needs and budget.
- Eaton uses sustainable materials and highly efficient manufacturing technology, thus generating dramatic savings in carbon footprint as compared to competitive UPS systems.

Eaton 9155M/9355M UPS 8-15 kVA

TECHNICAL SPECIFICATIONS

UPS output power rating (0,9 p.f.)

kVA	8	10	12	15
kW	7,2	9	10,8	13,5

General

Efficiency in double conversion mode (full load)	92% (without transformer)
Efficiency in double conversion mode (half load)	90% (without transformer)
Distributed paralleling with Hot Sync technology	4
Field upgradeable	yes
Inverter/rectifier topology	transformer-free IGBT with PWM
Audible noise	<50 dB
Colour	RAL 7035

Input

Nominal voltage rating (configurable)	380, 400, 415 V 50/60 Hz
With internal transformer	(9155): e.g. 230, 400, 440, 480, 690V
With external transformer	(9355): e.g. 230, 400, 440, 480, 690V
Input voltage range	Low -20% at 100% load/-50% at 50% load without battery discharge; High +10% /max +20%
Input frequency range	45-65 Hz
Input power factor	0,99
Input ITHD	less than 4,5%
Soft start capability	Yes
Internal backfeed protection	Yes

Output

Nominal voltage rating (configurable)	380, 400, 415 V 50/60 Hz
With external transformer	(9155): e.g. 230, 400, 440, 480, 690V
With internal transformer	(9355): e.g. 230, 400, 440, 480, 690V

Output UTHD	<3% (100% linear load); <5% (reference non linear load)
Output power factor	0,9 (e.g. 9 kW at 10 kVA)
Permitted load power factor	0,7 lagging - 0,8 leading

Battery

Type	Maintenance free VRLA batteries, NiCd
Charging method	ABM technology or Float
Temperature compensation	Optional
Battery nominal voltage (lead-acid)	384 V (32x12 V, 192 cells)
Charging current / Model	Default 3 A *Max 30 A

*May be limited by maximum UPS input current rating

Accessories

Isolation transformer, long-life batteries, external battery cabinets, UPS Center (input, bypass, distribution), X-Slot connectivity (Web/SNMP, ModBus/Jbus, Relay, Hot Sync, ViewUPS-X remote display), Hot Sync parallel tie cabinet, integrated manual bypass, external maintenance bypass switch

Communications

X-Slot	2 communication bays
Serial ports	1 available
Relay inputs/outputs	2/1 programmable

Compliance with standards

Safety	IEC 62040-1, IEC 60950-1
EMC	IEC 62040-2, IEC 60945
Performance	IEC 62040-3
Approvals	CE, DNV Type Approval, BV Type Approval and ABS PDA
Other classification survey reports	On request

Stand-alone UPS with 1-phase input

Description	Rating	Dimensions (HxWxD)	Weight with input transformer (net/gross)
9155-8-ST-M	8 kVA / 7.2 kW	960x313x714 (+150 mm)	170/190 kg
9155-10-ST-M	10 kVA / 9 kW	960x313x714 (+150 mm)	170/190 kg

Stand-alone UPS with 3-phase input

Description	Rating	Dimensions (HxWxD)	Weight with input transformer (net/gross)
9155-8-NT-M	8 kVA / 7.2 kW	960x313x714 (+150 mm)	170/190 kg
9155-10-NT-M	10 kVA / 9 kW	960x313x714 (+150 mm)	170/190 kg
9155-12-NT-M	12 kVA / 10.8 kW	960x313x714 (+150 mm)	170/190 kg
9155-15-NT-M	15 kVA / 13.5 kW	960x313x714 (+150 mm)	170/190 kg

External battery cabinets

Description	Rating	Back-up	Dimensions (HxWxD)	Weight (net/gross)
9X55-BAT-M-64x7Ah	2x32x7 Ah	See runtime spec.	880x347x718 (+150 mm)	217/237 kg
9X55-BAT-M-96x7Ah	3x32x7 Ah	See runtime spec.	1278x347x718 (+150 mm)	323/348 kg

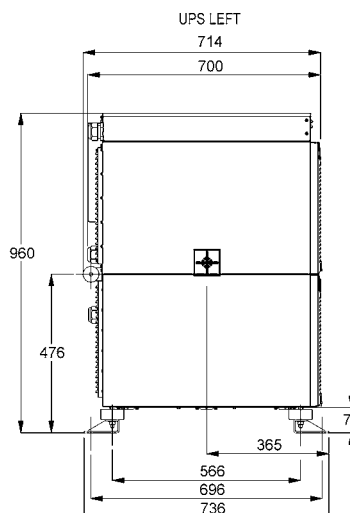
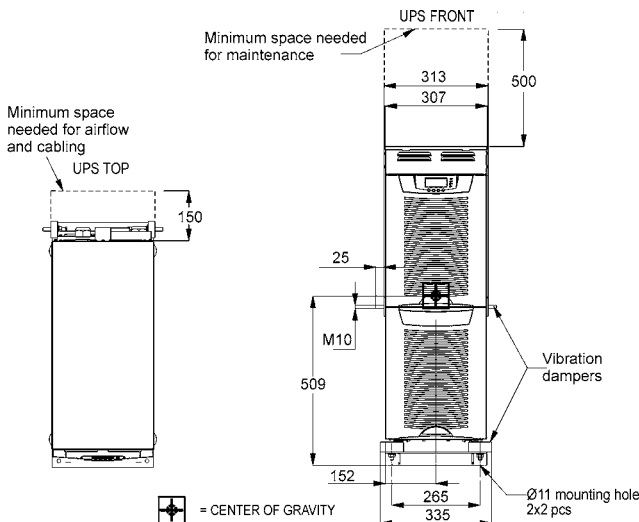

TYPE APPROVED PRODUCT