



ИБП Eaton Powerware 9390-120-U-4x0 - Установка и управление системой Sync Control для ИБП Ea

Постоянная ссылка на страницу: <https://eaton-power.ru/catalog/eaton-9390/9390-120-u-4x0/>

Eaton® 9390 UPS, 9395 UPS, and 9395 SSBM

**Sync Control
Installation and Operation Manual**



Powering Business Worldwide

Eaton® 9390 UPS, 9395 UPS, and 9395 SSBM

**Sync Control
Installation and Operation Manual**



Powering Business Worldwide

IMPORTANT SAFETY INSTRUCTIONS SAVE THESE INSTRUCTIONS

This manual contains important instructions that you should follow during installation and maintenance of the UPS and batteries. Please read all instructions before operating the equipment and save this manual for future reference.

CONSIGNES DE SÉCURITÉ IMPORTANTES CONSERVER CES INSTRUCTIONS

Ce manuel comporte des instructions importantes que vous êtes invité à suivre lors de toute procédure d'installation et de maintenance des batteries et de l'onduleur. Veuillez consulter entièrement ces instructions avant de faire fonctionner l'équipement et conserver ce manuel afin de pouvoir vous y reporter ultérieurement.

Eaton and X-Slot are registered trademarks of Eaton Corporation or its subsidiaries and affiliates. National Electric Code and NEC are a registered trademarks of National Fire Protection Association, Inc. All other trademarks are property of their respective companies.

©Copyright 2005–2011 Eaton Corporation, Raleigh, NC, USA. All rights reserved. No part of this document may be reproduced in any way without the express written approval of Eaton Corporation.

Table of Contents

1	Introduction	1-1
1.1	Conventions Used in This Manual	1-2
1.2	Safety Warnings	1-3
1.3	For More Information	1-4
1.4	Getting Help	1-4
2	Installation Plan and Unpacking	2-1
2.1	Creating an Installation Plan	2-1
2.2	Preparing the Site	2-1
2.2.1	Environmental and Installation Considerations	2-1
2.2.2	Eaton Sync Control Wiring Preparation	2-4
2.3	Inspecting and Unpacking the Eaton Sync Control	2-4
3	Installation	3-1
3.1	Installation and Wiring with an Eaton 9390 UPS	3-1
3.2	Installation and Wiring with an Eaton 9395 UPS	3-8
3.3	Installation and Wiring with an Eaton 9395 SBM	3-16
4	Operating Instructions	4-1
4.1	Startup for UPS Systems Equipped with an Eaton Sync Control	4-1
4.2	Understanding Eaton Sync Control Operation	4-1
4.3	Operation	4-3
4.4	Maintenance Operations	4-5
5	Warranty	5-1

List of Figures

Figure 1-1.	Eaton Sync Control	1-1
Figure 1-2.	Eaton Sync Control with Door Open	1-2
Figure 2-1.	Eaton Sync Control Dimensions – Front View	2-2
Figure 2-2.	Eaton Sync Control Dimensions – Side Views	2-3
Figure 3-1.	Typical Eaton Sync Control Wiring Terminal Locations	3-2
Figure 3-2.	Eaton Sync Control TB1 Terminal Block Detail	3-4
Figure 3-3.	Eaton 9390 UPS (40–80 kVA) Interface Locations for Eaton Sync Control	3-5
Figure 3-4.	Eaton 9390 UPS (100–160 kVA) Interface Locations for Eaton Sync Control	3-6
Figure 3-5.	TB6 Terminal Block Detail	3-7
Figure 3-6.	Mini CSB Interface Terminals	3-7
Figure 3-7.	Eaton 9395 UPS (225–275 kVA) Interface Locations for Eaton Sync Control	3-10
Figure 3-8.	Eaton 9395 UPS and Plus 1 UPS (450–550 kVA) Interface Locations for Eaton Sync Control	3-11
Figure 3-9.	Eaton 9395 UPS and Plus 1 UPS (650–825 kVA) Interface Locations for Eaton Sync Control	3-12
Figure 3-10.	Eaton 9395 UPS (1000–1100 kVA) Interface Locations for Eaton Sync Control	3-13
Figure 3-11.	Industrial Relay Card End View for AS400	3-14
Figure 3-12.	Industrial Relay Card Terminals for AS400	3-14
Figure 3-13.	Relay Interface Card	3-15
Figure 3-14.	SBM Control Pan Interface Terminal Locations	3-18
Figure 3-15.	TB1 and TB2 Interface Terminal Detail	3-19
Figure 3-16.	TB4 and TB5 Interface Terminal Detail	3-19
Figure 3-17.	Terminal Block TB2 Connector Assignments	3-20
Figure 3-18.	Terminal Block TB3 Connector Assignments	3-20
Figure 3-19.	SBM to UPS Interconnection System Control Wiring	3-21
Figure 4-1.	Typical Eaton Sync Control Block Diagram with a Eaton 9390 UPS, Eaton 9395 UPS, or 9395 SSBM.	4-2
Figure 4-2.	Synchronization Reference Control	4-3
Figure 4-3.	Eaton Sync Control Controls and Indicators	4-4

Chapter 1

Introduction

The Eaton® Sync Control maintains the critical load outputs of either two separate single Eaton 9390 UPS or Switchboard System Bypass Module (SSBM) systems or two separate single Eaton 9395 UPS or SSBM systems in synchronization. Use of the Eaton Sync Control provides the uninterrupted transfer of the load from one load bus to another by means of downstream, dual-source, solid-state, transfer switches. Without the load sync option, the two system output (critical load) buses could become out of phase with each other. This condition occurs if suitable bypass sources are not available or if the bypass sources feeding each system are not in sync with each other. Examples of this condition are two systems supplied by separate diesel generator sets, or the bypass sources for the two systems are lost.

Figure 1-1 shows the front view and Figure 1-2 shows the interior view of the Eaton Sync Control.

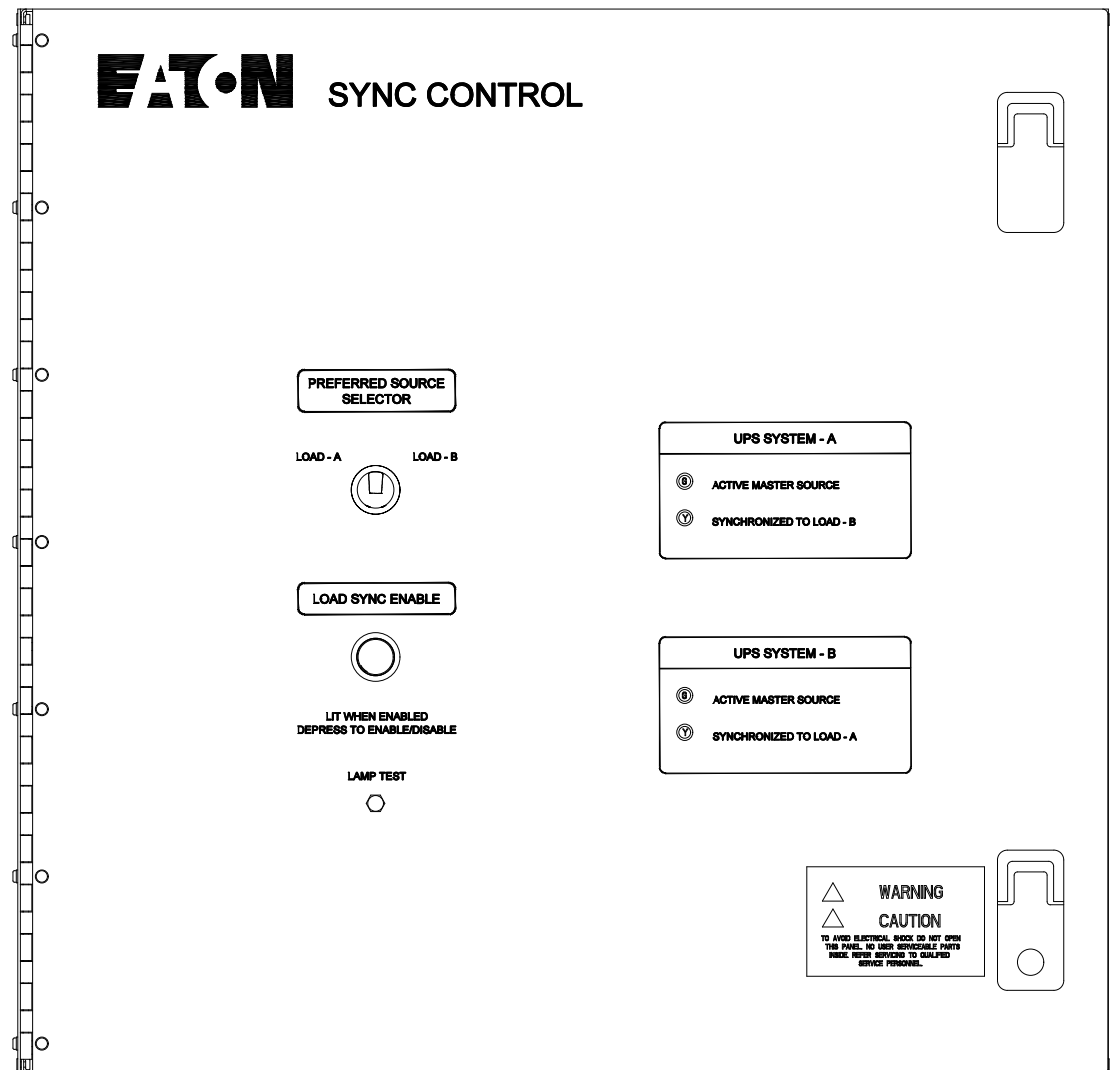

Figure 1-1. Eaton Sync Control

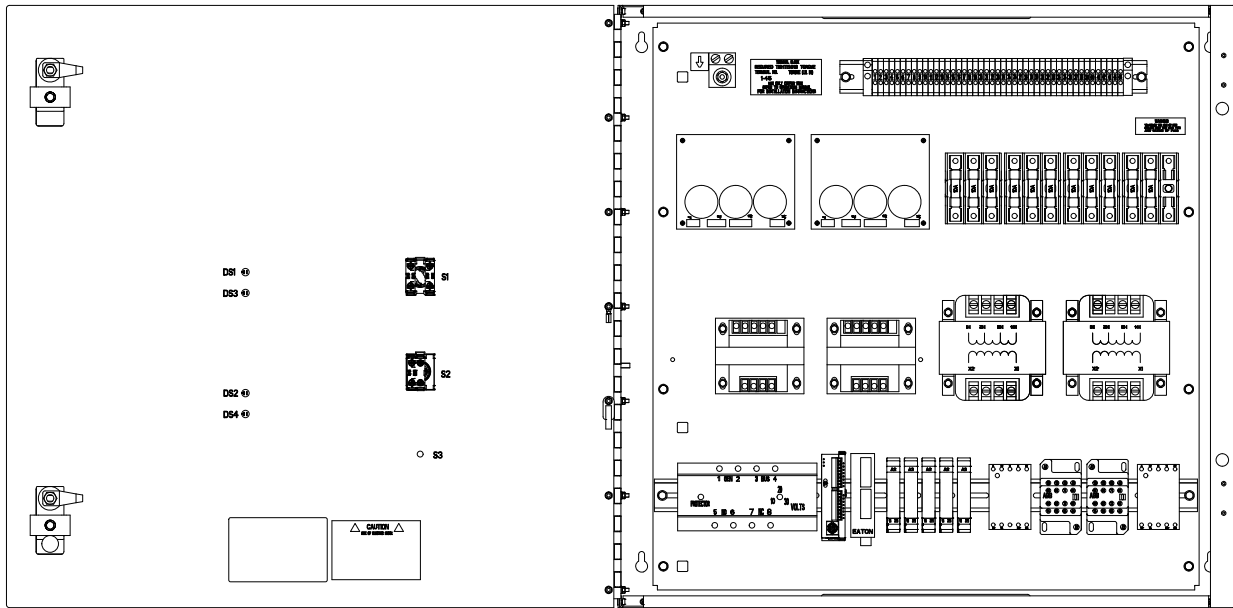

Figure 1-2. Eaton Sync Control with Door Open

1.1 Conventions Used in This Manual

This manual uses these type conventions:

- **Bold type** highlights important concepts in discussions, key terms in procedures, and menu options, or represents a command or option that you type or enter at a prompt.
- *Italic type* highlights notes and new terms where they are defined.
- **Screen type** represents information that appears on the screen or LCD.

Icon	Description
	Information notes call attention to important features or instructions.
[Keys]	Brackets are used when referring to a specific key, such as [Enter] or [Ctrl].

In this manual, the term *UPS* refers only to the UPS cabinet and its internal elements. The term *UPS system* refers to the entire power protection system – the UPS cabinet, the battery cabinet, and options or accessories installed.

1.2 Safety Warnings

IMPORTANT SAFETY INSTRUCTIONS SAVE THESE INSTRUCTIONS

This manual contains important instructions that should be followed during installation and maintenance of the UPS or SBM and batteries. Please read all instructions before operating the equipment and save this manual for future reference.

The UPS or SBM cabinet is designed for industrial or computer room applications, and contains safety shields behind the doors. However, these units comprise a sophisticated power system and should be handled with appropriate care.

DANGER



The UPS or SBM contain **LETHAL VOLTAGES**. All repairs and service should be performed by **AUTHORIZED SERVICE PERSONNEL ONLY**. There are **NO USER SERVICEABLE PARTS** inside the UPS or SBM.

WARNING



- The UPS system contains its own energy source (batteries). The output terminals may carry live voltage even when the UPS is disconnected from an AC source.
- To reduce the risk of fire or electric shock, install this UPS or SBM in a temperature and humidity controlled, indoor environment, free of conductive contaminants. Ambient temperature must not exceed 40°C (104°F). Do not operate near water or excessive humidity (95% maximum). These systems are not intended for outdoor use.
- Ensure all power is disconnected before performing installation or service.

CAUTION



- Keep the UPS or SBM doors closed to ensure proper cooling airflow and to protect personnel from dangerous voltages inside the unit.
- Do not operate the UPS or SBM close to gas or electric heat sources.
- The operating environment should be maintained within the parameters stated in this manual.
- Keep surroundings uncluttered, clean, and free from excess moisture.
- Observe all DANGER, CAUTION, and WARNING notices affixed to the inside and outside of the equipment.

1.3 For More Information

Refer to the following manuals for additional information:

- *Eaton 9390 UPS (40–80 kVA) Installation and Operation Manual*
- *Eaton 9390 UPS (100–160 kVA) Installation and Operation Manual*
- *Eaton 9395 UPS (225–275 kVA) Installation and Operation Manual*
- *Eaton 9395 Plus 1 UPS (225–275 kVA) Installation and Operation Manual*
- *Eaton 9395 UPS (300 kVA) Installation and Operation Manual*
- *Eaton 9395 550/275 UPS (225–550 kVA) Installation and Operation Manual*
- *Eaton 9395 UPS and Plus 1 UPS (450–550 kVA) Installation and Operation Manual*
- *Eaton 9395 UPS and Plus 1 UPS (650–825 kVA) Installation and Operation Manual*
- *Eaton 9395 UPS (1000–1100 kVA) Installation and Operation Manual*
- *Eaton 9395 SBM Installation and Operation Manual*

These manuals describe:

- UPS or SBM cabinet, optional components, and accessory installation instructions, including site preparation, planning for installation, and wiring and safety information. Detailed illustrations of cabinets and optional accessories with dimensional and connection point drawings are provided.
- UPS or SBM operation, including cabinet controls, functions of the unit, standard features and optional accessories, procedures for starting and stopping the UPS or SBM, and information about maintenance and responding to system events.
- Communication capabilities of the UPS or SBM system.

Visit www.eaton.com/powerquality or contact Eaton service representative for information on how to obtain copies of these manuals.

1.4 Getting Help

If help is needed with any of the following:

- Scheduling initial startup
- Regional locations and telephone numbers
- A question about any of the information in this manual
- A question this manual does not answer

Please call the Help Desk at:

United States:	1-800-843-9433 or 1-919-870-3028
Canada:	1-800-461-9166 ext 260
All other countries:	Call your local service representative

Chapter 2

Installation Plan and Unpacking

The Eaton Sync Control is shipped as a separate item and can be mounted on any surface that can safely bear its weight. See paragraph 2.2 for weight, dimensions, and wiring preparation.

2.1 Creating an Installation Plan

Before installing the UPS system, read and understand how this manual applies to the system being installed. Use the procedures and illustrations in the following chapters to create a logical plan for installing the system.



NOTE Startup and operational checks must be performed by an authorized Eaton Customer Service Engineer, or the warranty terms as specified on page 5-1 become void. This service is offered as part of the sales contract for the UPS. Contact service in advance (usually a two-week notice is required) to reserve a preferred startup date.

2.2 Preparing the Site

For the Eaton Sync Control to operate at peak efficiency, the installation site should meet the environmental parameters outlined in the applicable Eaton 9390 or Eaton 9395 UPS or SSBM installation and operation manual listed in paragraph 1.3.

2.2.1 Environmental and Installation Considerations

The life of the Eaton Sync Control is adversely affected if the system is not installed in a temperature and humidity controlled indoor area free of conductive contaminants.

Failure to follow guidelines may void your warranty.

The UPS equipment operating environment must meet the weight requirements shown in Table 2-1 and the size requirements shown in Figure 2-1 and Figure 2-2. Dimensions are in millimeters (inches).

Table 2-1. Equipment Weight

Model	Weight kg (lb)	
	Shipping	Installed
Eaton Sync Control	45.4 (100)	36.3 (80)

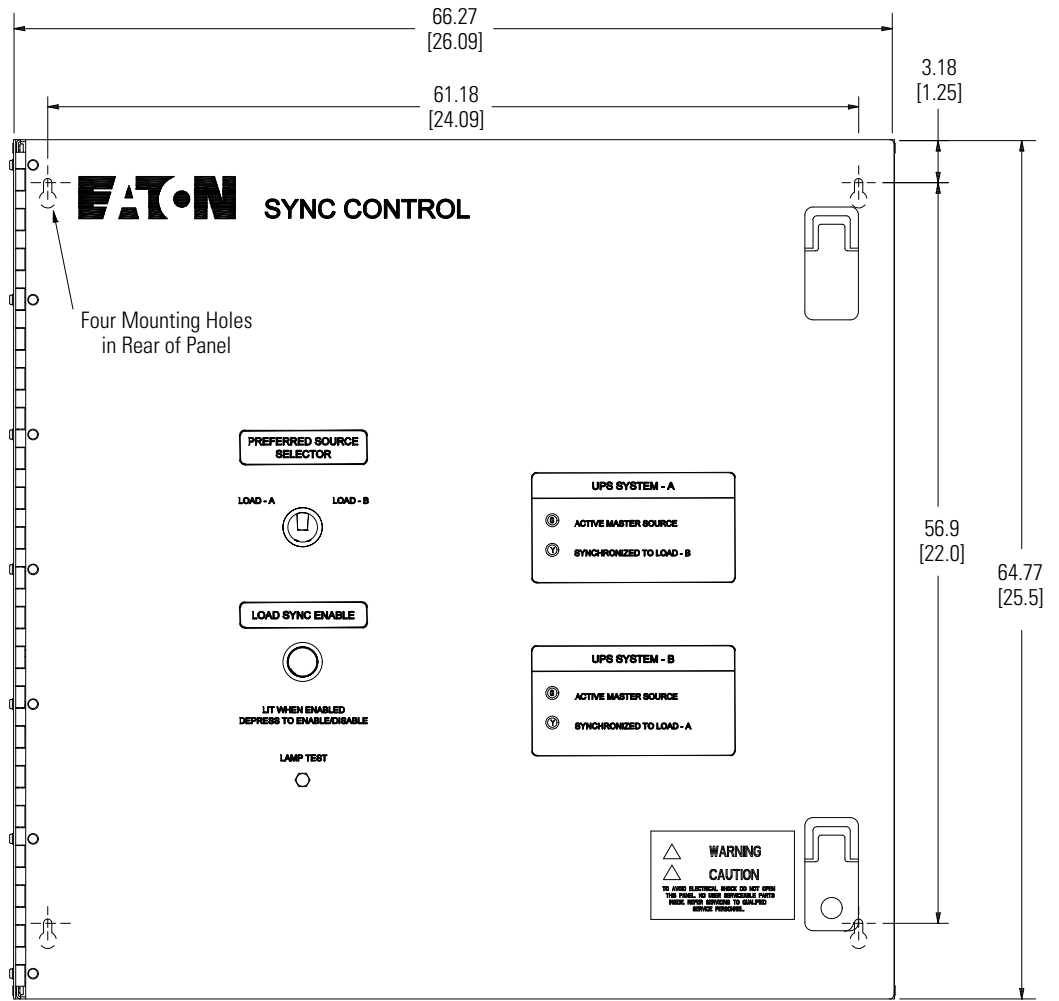

FRONT VIEW

Dimensions are in millimeters [inches].

Figure 2-1. Eaton Sync Control Dimensions – Front View

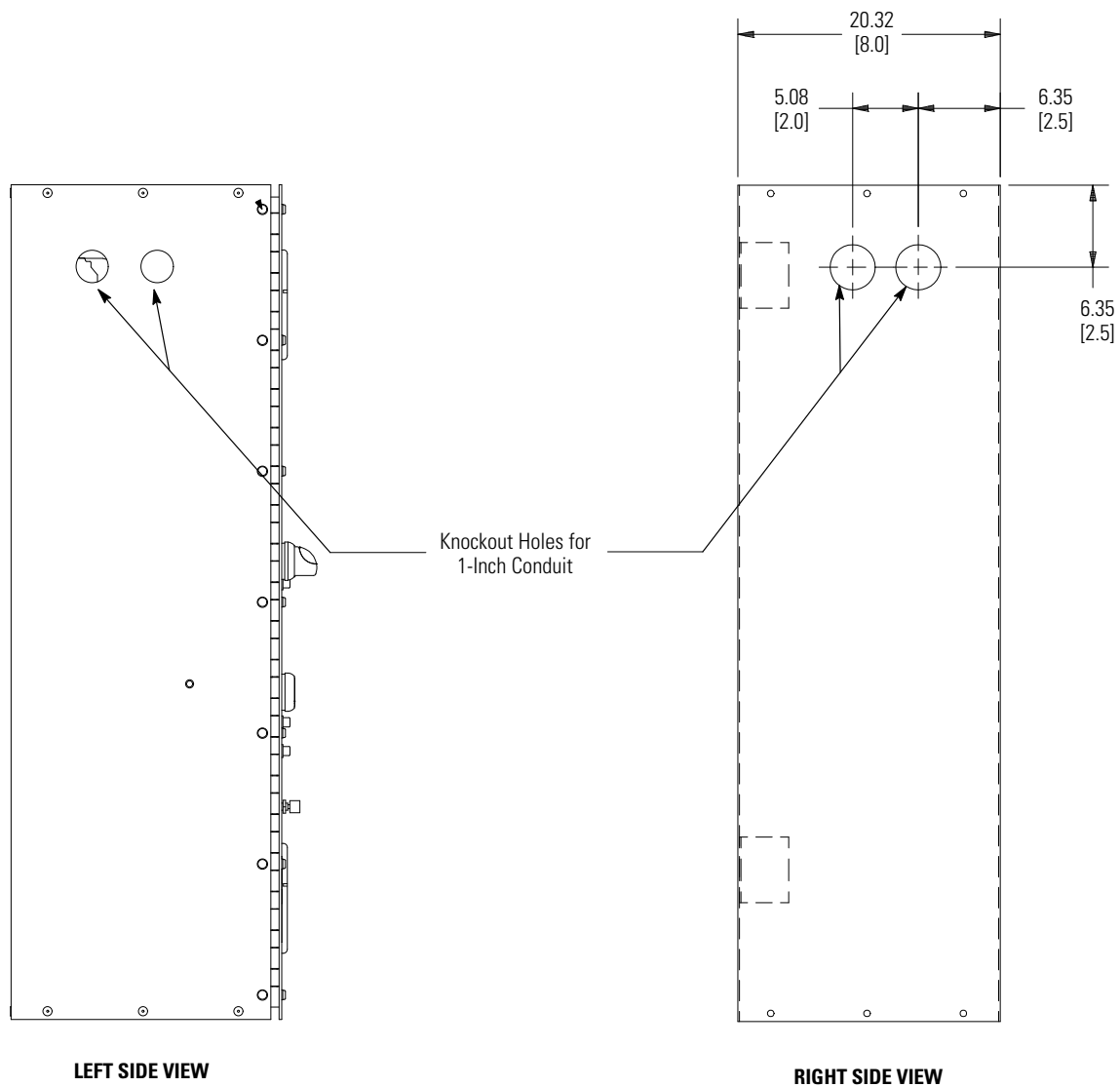

Dimensions are in millimeters [inches].

Figure 2-2. Eaton Sync Control Dimensions – Side Views

2.2.2 Eaton Sync Control Wiring Preparation

Read and understand the following notes while planning and performing the installation:

- Refer to national and local electrical codes for acceptable external wiring practices.
- Material and labor for external wiring requirements are to be provided by designated personnel.
- For external wiring, use 90°C copper wire with a minimum insulation rating of 600V. If wire is run in an ambient temperature greater than 30°C, higher temperature wire and/or larger size wire may be necessary. See the applicable wiring information in Table 3-1 for the Eaton 9390 UPS, Table 3-2 for the Eaton 9395 UPS, and Table 3-4 for the Eaton 9395 SSBM.
- Use 14 AWG wiring with a minimum insulation rating of 600V for interconnections between the Eaton Sync Control, the UPS, and the customer remote monitoring system.
- Use Class 1 wiring methods (as defined by the NEC®) for interface wiring up to 30V. The wire should be rated at 24V, 1A minimum.
- Use Class 2 wiring methods (as defined by the NEC) for interface wiring from 30 to 600V. The wire should be rated at 600V, 1A minimum and 12 AWG maximum.
- Sync Control dry contacts are rated at 250 Vac/Vdc at 6A per contact (maximum load).
- When installing external wiring between the Eaton Sync Control and the UPS or SSBM, conduit must be installed between the Sync Control and the UPS or SSBM cabinet.
- The Eaton Sync Control can be installed up to a maximum of 152.4m (500 ft) from the Eaton 9390 UPS, Eaton 9395 UPS or Eaton 9395 SSBM system.

CAUTION



When connecting the bypass and load voltage from another model UPS to an Eaton 9390 or Eaton 9395 UPS using the Eaton Sync Control accessory, use Phase A, Phase B, and Neutral connections from the other UPS. DO NOT connect the other model UPS Phase C bypass and load voltage to the Sync Control connection point when connecting to an Eaton 9390 UPS or Eaton 9395 UPS.

2.3 Inspecting and Unpacking the Eaton Sync Control

The unit arrives covered with protective packaging material.

1. Carefully inspect the outer packaging for evidence of damage during transit.

CAUTION



Do not install a damaged cabinet. Report any damage to the carrier and contact your Eaton service representative immediately.

2. Remove the protective cardboard covering from the Eaton Sync Control by cutting where indicated using a knife blade no longer than 25 mm (1").
3. Remove the plastic bag and foam packing material, and discard or recycle them in a responsible manner.



WARNING

- Only qualified service personnel (such as a licensed electrician) shall perform the electrical installation. Risk of electrical shock.
- Shut down all sources of power to the Eaton 9390 UPS or Eaton 9395 UPS or SSBM system before connecting the control wiring to the Eaton Sync Control enclosure and UPS. Hazardous voltages exist inside the UPS or SSBM and in the Eaton Sync Control enclosure. Check all terminal conductors with a known serviceable voltmeter before connecting the wiring.

Once the Eaton Sync Control has been moved to its installed location, unpacked, and inspected, it is ready for installation and wiring.

Use the applicable procedure from the following list to install the Eaton Sync Control to the UPS:

- With an Eaton 9390 UPS, proceed to paragraph 3.1.
- With an Eaton 9395 UPS, proceed to paragraph 3.2.
- With an Eaton 9395 SSBM, proceed to paragraph 3.3.

3.1 Installation and Wiring with an Eaton 9390 UPS



NOTE When installing wiring connections, conduit must be installed between the Eaton Sync Control and the UPS cabinet.

To install and wire:

1. Install the Eaton Sync Control panel to the selected mounting location.

See Figure 2-1 on page 2-2 for mounting hole dimensions and Figure 2-2 on page 2-3 for conduit entrance locations.

2. Unfasten the front door latches and swing the door open.
3. Complete all control wiring interconnections using Table 3-1 for wiring requirements.

Figure 3-1 shows the Eaton Sync Control TB1 terminal block and ground terminal locations. Figure 3-2 shows the TB1 terminal block wiring detail.

Figure 3-3 and Figure 3-4 show the typical locations of the UPS TB1, TB2, and TB6 interconnect terminal blocks. Figure 3-5 shows the TB6 detail.

Refer to the applicable Eaton 9390 UPS Installation and Operation Manual listed in paragraph 1.3 for UPS cabinet terminal locations and assignments, termination requirements, conduit landing locations, and terminal access instructions.

4. Verify the jumper is installed between Sync Control terminal TB1-40 and TB1-41 (see Figure 3-2).
5. When all wiring is complete, close the door and secure the latches.

CAUTION



When connecting the bypass and load voltage from another model UPS to an Eaton 9390 UPS using the Eaton Sync Control accessory, use Phase A, Phase B, and Neutral connections from the other UPS. DO NOT connect the other model UPS Phase C bypass and load voltage to the Sync Control connection point when connecting to an Eaton 9390 UPS.

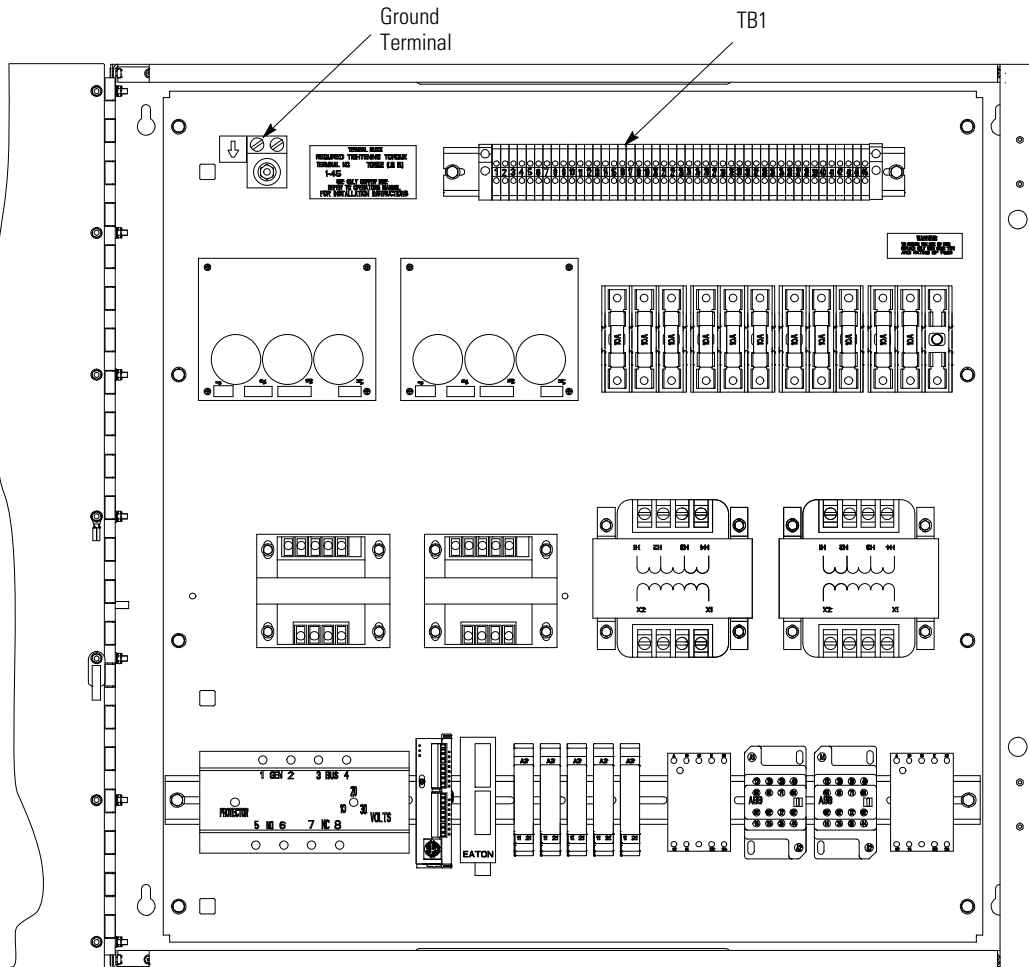
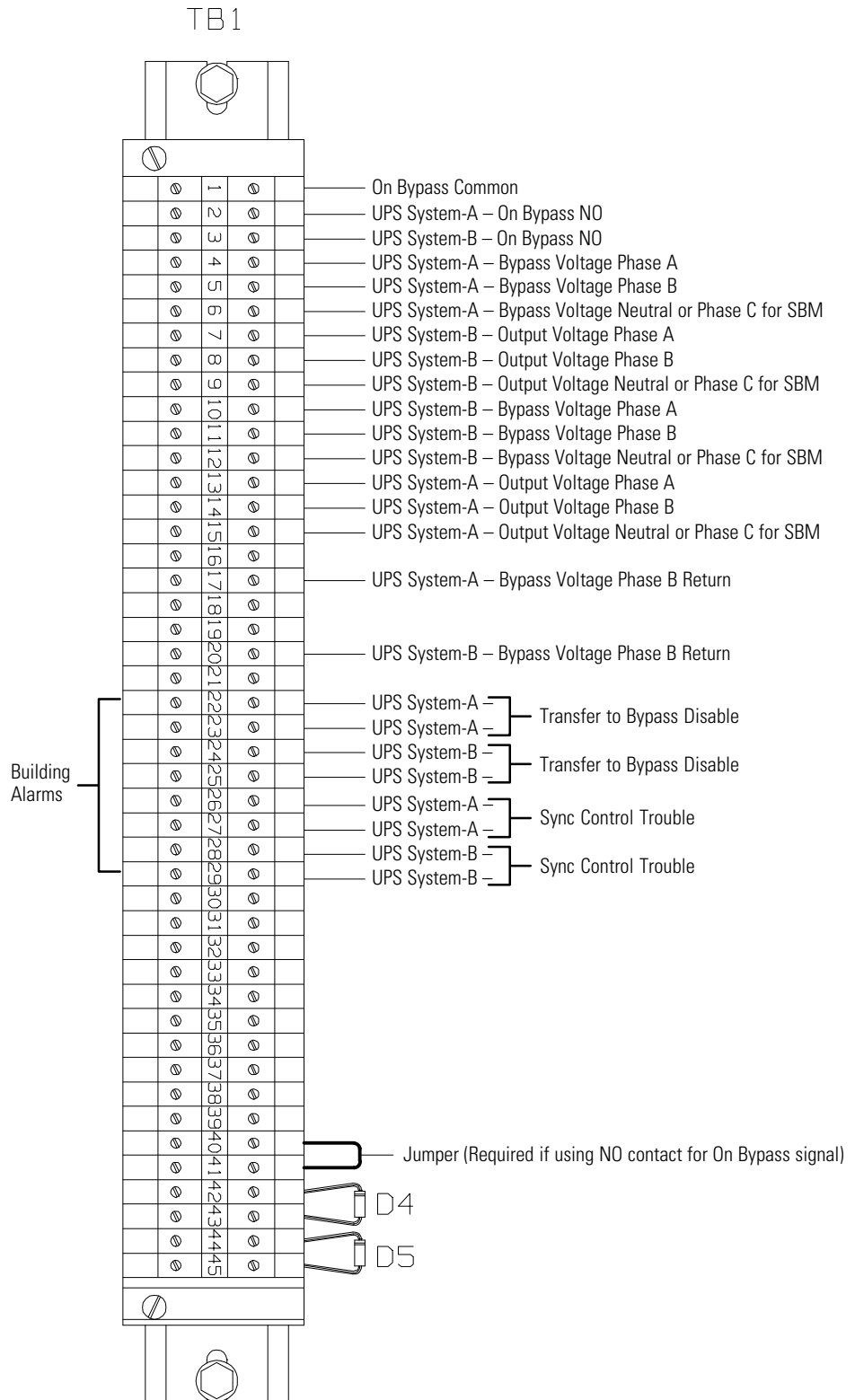

Figure 3-1. Typical Eaton Sync Control Wiring Terminal Locations

Table 3-1. Eaton 9390 UPS System Control Wiring Interconnections

From UPS System-A	To Sync Control	Function	Note
TB6-1	TB1-4	Bypass Voltage Phase A	14 AWG Twist Together
TB6-2	TB1-5	Bypass Voltage Phase B	
TB6-3	TB1-6	Bypass Voltage Neutral	
TB6-4	TB1-13	Output Voltage Phase A	14 AWG Twist Together
TB6-5	TB1-14	Output Voltage Phase B	
TB6-6	TB1-15	Output Voltage Neutral	
TB6-9	TB1-17	Bypass Voltage Phase B Return	14 AWG
P5-5	TB1-22	Transfer to Bypass Disable (24 Vdc)	14 AWG
P5-6	TB1-23	Transfer to Bypass Disable Return (24 Vdc)	Twist Together
P5-7	TB1-26	Sync Control Trouble (24 Vdc)	14 AWG
P5-8	TB1-27	Sync Control Trouble Return (24 Vdc)	Twist Together
TB-4 (Relay Interface Card)*	TB1-1	On Bypass Common	14 AWG
TB-6 (Relay Interface Card)*	TB1-2	On Bypass NO	Twist Together
OR			
J2-5 (Industrial Relay Card)*	TB1-1	On Bypass Common	14 AWG
J2-6 (Industrial Relay Card)*	TB1-2	On Bypass NO	Twist Together
From UPS System-B	To Sync Control	Function	Note
TB6-1	TB1-10	Bypass Voltage Phase A	14 AWG Twist Together
TB6-2	TB1-11	Bypass Voltage Phase B	
TB6-3	TB1-12	Bypass Voltage Neutral	
TB6-4	TB1-7	Output Voltage Phase A	14 AWG Twist Together
TB6-5	TB1-8	Output Voltage Phase B	
TB6-6	TB1-9	Output Voltage Neutral	
TB6-9	TB1-20	Bypass Voltage Phase B Return	14 AWG
P5-5	TB1-24	Transfer to Bypass Disable (24 Vdc)	14 AWG
P5-6	TB1-25	Transfer to Bypass Disable Return (24 Vdc)	Twist Together
P5-7	TB1-28	Sync Control Trouble (24 Vdc)	14 AWG
P5-8	TB1-29	Sync Control Trouble Return (24 Vdc)	Twist Together
TB-4 (Relay Interface Card)*	TB1-1	On Bypass Common	14 AWG
TB-6 (Relay Interface Card)*	TB1-3	On Bypass NO	Twist Together
OR			
J2-5 (Industrial Relay Card)*	TB1-1	On Bypass Common	14 AWG
J2-6 (Industrial Relay Card)*	TB1-3	On Bypass NO	Twist Together

* Both relay Interface card (RIC) and the Industrial Relay Card (IRC) shall be set up / verified for RMP by the Eaton Field Service Engineer.



NOTE Any unused Building Alarm(s) may be used.

Figure 3-2. Eaton Sync Control TB1 Terminal Block Detail

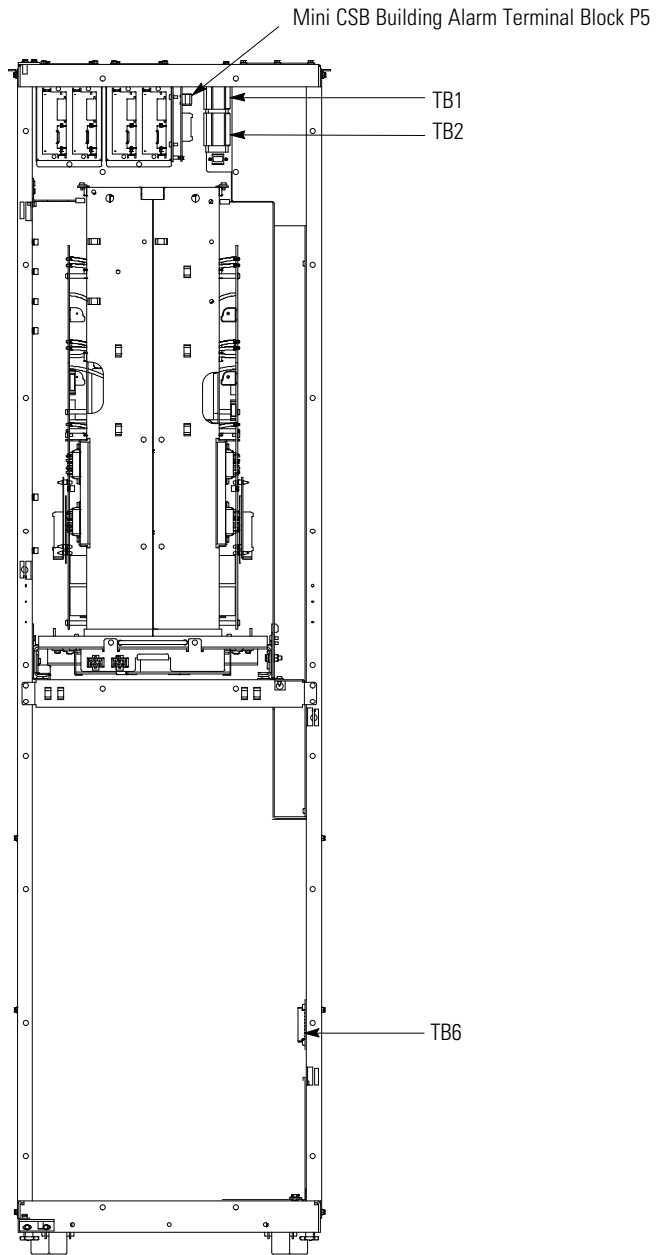

Figure 3-3. Eaton 9390 UPS (40–80 kVA) Interface Locations for Eaton Sync Control

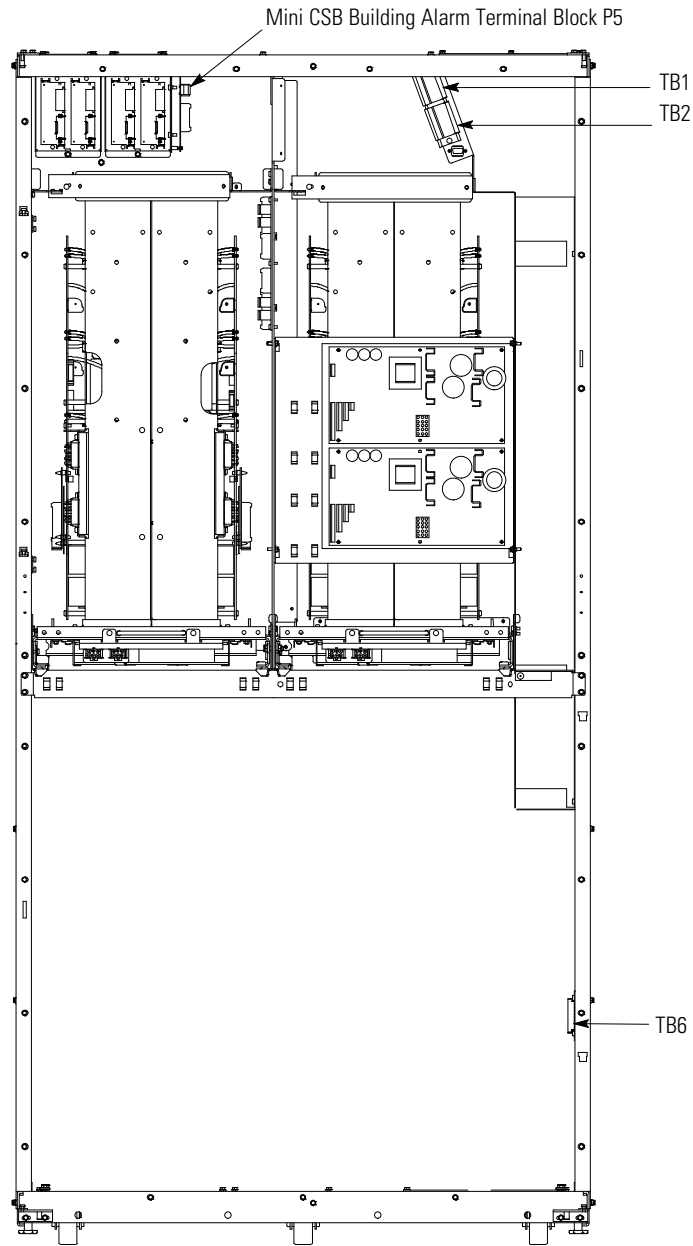

Figure 3-4. Eaton 9390 UPS (100–160 kVA) Interface Locations for Eaton Sync Control

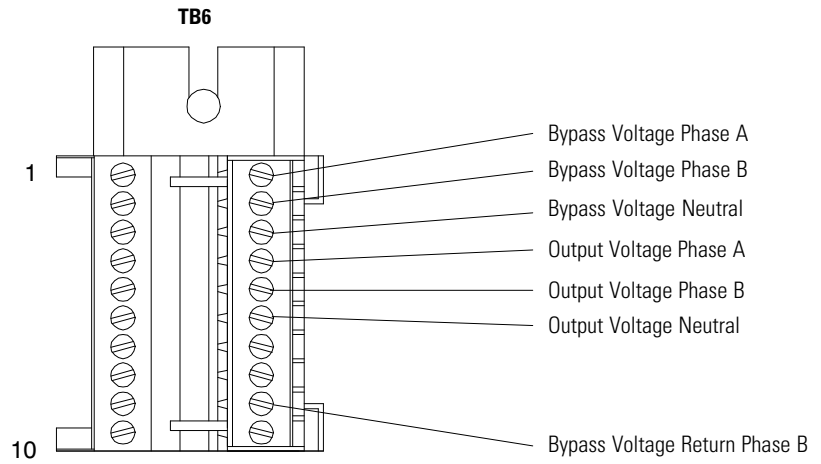

Figure 3-5. TB6 Terminal Block Detail

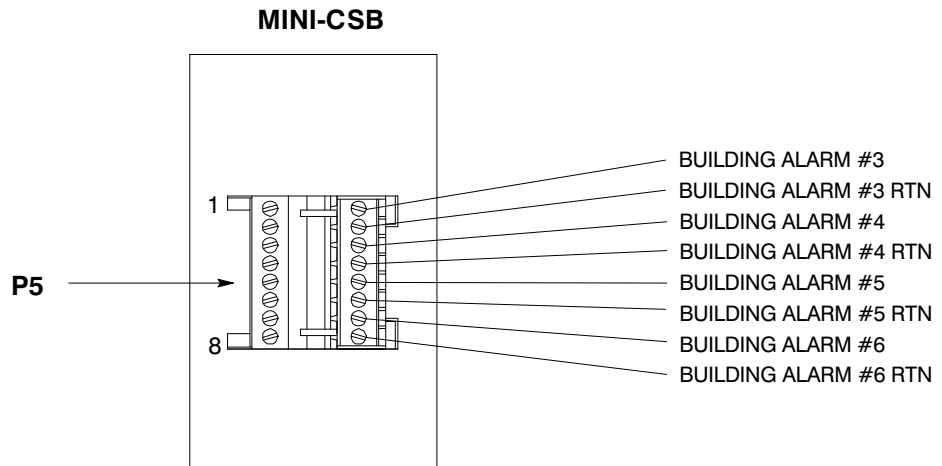

Figure 3-6. Mini CSB Interface Terminals

3.2 Installation and Wiring with an Eaton 9395 UPS



NOTE When installing wiring connections, conduit must be installed between the Eaton Sync Control and the UPS cabinet.

To install and wire:

1. Install the Eaton Sync Control panel to the selected mounting location.
See Figure 2-1 on page 2-2 for mounting hole dimensions and Figure 2-2 on page 2-3 for conduit entrance locations.
2. Unfasten the front door latches and swing the door open.
3. Complete all control wiring interconnections using Table 3-2 for wiring requirements.

Figure 3-1 shows the Eaton Sync Control TB1 terminal block and ground terminal locations. Figure 3-2 shows the TB1 terminal block wiring detail.

Figure 3-7 through Figure 3-10 show the typical locations of the UPS TB3, TB6, and X-Slot® Communication bays. Figure 3-5 shows the TB6 detail.

Refer to the applicable Eaton 9395 UPS Installation and Operation Manual listed in paragraph 1.3 on page 1-4 for UPS cabinet terminal locations and assignments, termination requirements, conduit landing locations, and terminal access instructions.



NOTE Complete the wiring to the X-Slot Relay Interface Card or Industrial Relay Card terminals before installing the cards in the Communication Bay in each of the UPS cabinets.

4. Route wires through the strain relief bushing and connect to the terminals on the X-Slot Relay Interface Card in each of the UPS cabinets (see Figure 3-13).
5. Install the X-Slot Relay Interface Card or Industrial Relay Card into an open X-Slot communication bay on the front of the UPS (see Figure 3-7, Figure 3-8, Figure 3-9, or Figure 3-10). Refer to the applicable Eaton 9395 UPS Installation and Operation Manual listed in paragraph 1.3 on for UPS cabinet access instructions.
6. Verify the jumper is installed between Sync Control terminal TB1-40 and TB1-41 (see Figure 3-2).
7. When all wiring is complete, close the door and secure the latch.

CAUTION



When connecting the bypass and load voltage from another model UPS to a Eaton 9395 UPS using the Eaton Sync Control accessory, use Phase A, Phase B, and Neutral connections from the other UPS. DO NOT connect the other model UPS Phase C bypass and load voltage to the Sync Control connection point when connecting to an Eaton 9395 UPS.

Table 3-2. Eaton 9395 UPS System Control Wiring Interconnections

From UPS System-A	To Sync Control	Function	Note
TB6-1	TB1-4	Bypass Voltage Phase A	14 AWG Twist Together
TB6-2	TB1-5	Bypass Voltage Phase B	
TB6-3	TB1-6	Bypass Voltage Neutral	
TB6-4	TB1-13	Output Voltage Phase A	14 AWG Twist Together
TB6-5	TB1-14	Output Voltage Phase B	
TB6-6	TB1-15	Output Voltage Neutral	
TB6-9	TB1-17	Bypass Voltage Phase B Return	14 AWG
TB3-1	TB1-22	Transfer to Bypass Disable (24 Vdc)	14 AWG Twist Together
TB3-2	TB1-23	Transfer to Bypass Disable Return (24 Vdc)	
TB3-3	TB1-26	Sync Control Trouble (24 Vdc)	14 AWG Twist Together
TB3-4	TB1-27	Sync Control Trouble Return (24 Vdc)	
TB-4 (Relay Interface Card)*	TB1-1	On Bypass Common	14 AWG Twist Together
TB-6 (Relay Interface Card)*	TB1-2	On Bypass NO	
OR			
J2-5 (Industrial Relay Card)*	TB1-1	On Bypass Common	14 AWG Twist Together
J2-6 (Industrial Relay Card)*	TB1-2	On Bypass NO	
From UPS System-B	To Sync Control	Function	Note
TB6-1	TB1-10	Bypass Voltage Phase A	14 AWG Twist Together
TB6-2	TB1-11	Bypass Voltage Phase B	
TB6-3	TB1-12	Bypass Voltage Neutral	
TB6-4	TB1-7	Output Voltage Phase A	14 AWG Twist Together
TB6-5	TB1-8	Output Voltage Phase B	
TB6-6	TB1-9	Output Voltage Neutral	
TB6-9	TB1-20	Bypass Voltage Phase B Return	14 AWG
TB3-1	TB1-24	Transfer to Bypass Disable (24 Vdc)	14 AWG Twist Together
TB3-2	TB1-25	Transfer to Bypass Disable Return (24 Vdc)	
TB3-3	TB1-28	Sync Control Trouble (24 Vdc)	14 AWG Twist Together
TB3-4	TB1-29	Sync Control Trouble Return (24 Vdc)	
TB-4 (Relay Interface Card)*	TB1-1	On Bypass Common	14 AWG Twist Together
TB-6 (Relay Interface Card)*	TB1-3	On Bypass NO	
OR			
J2-5 (Industrial Relay Card)*	TB1-1	On Bypass Common	14 AWG Twist Together
J2-6 (Industrial Relay Card)*	TB1-3	On Bypass NO	

* Both relay Interface card (RIC) and the Industrial Relay Card (IRC) shall be set up / verified for RMP by the Eaton Field Service Engineer.

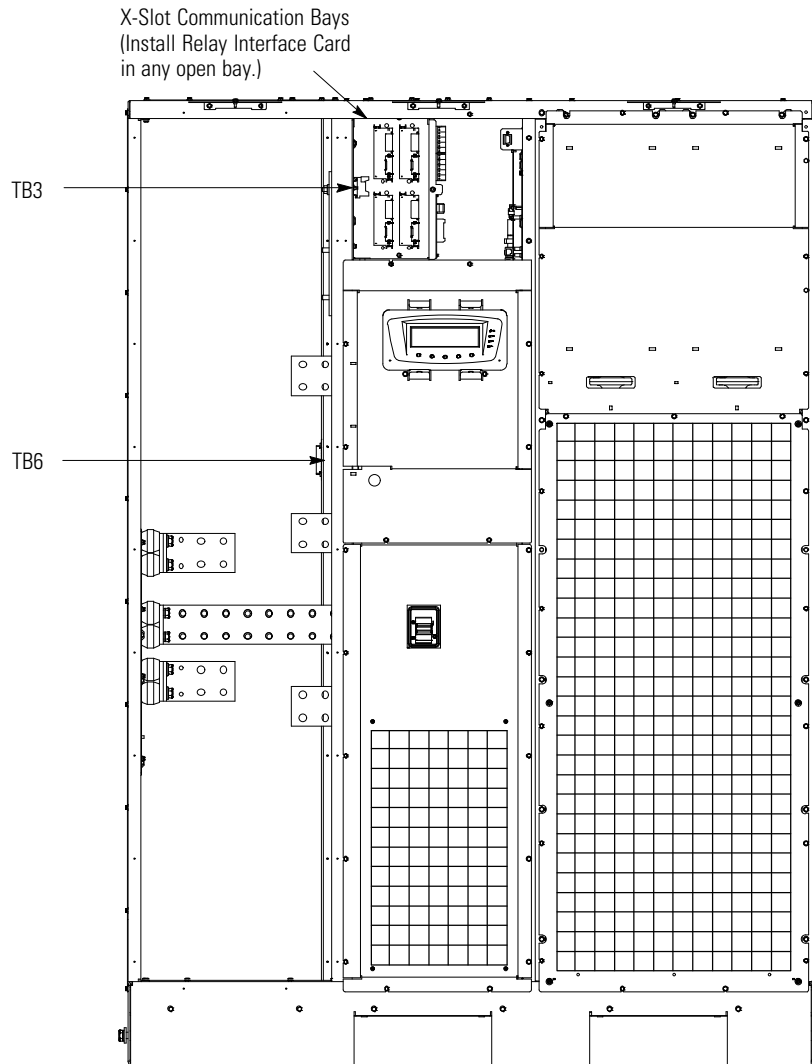

NOTE Interface connections are located in the same positions on the 9395 550/275 UPS (225-550 kVA) and the 9395 UPS (300 kVA).

Figure 3-7. Eaton 9395 UPS (225–275 kVA) Interface Locations for Eaton Sync Control

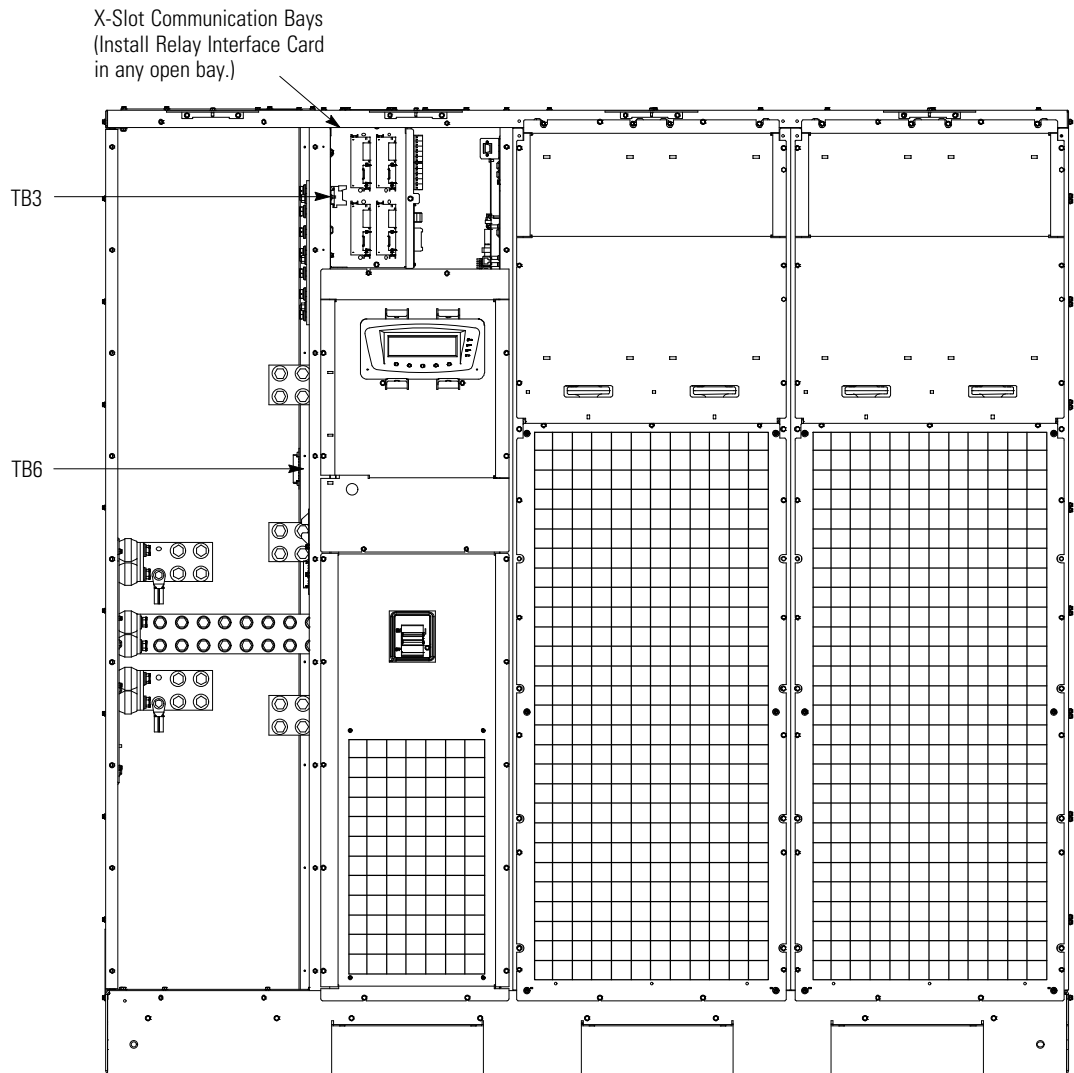

NOTE Interface connections are located in the same positions on the 9395 Plus 1 UPS (225-275 kVA).

Figure 3-8. Eaton 9395 UPS and Plus 1 UPS (450–550 kVA) Interface Locations for Eaton Sync Control

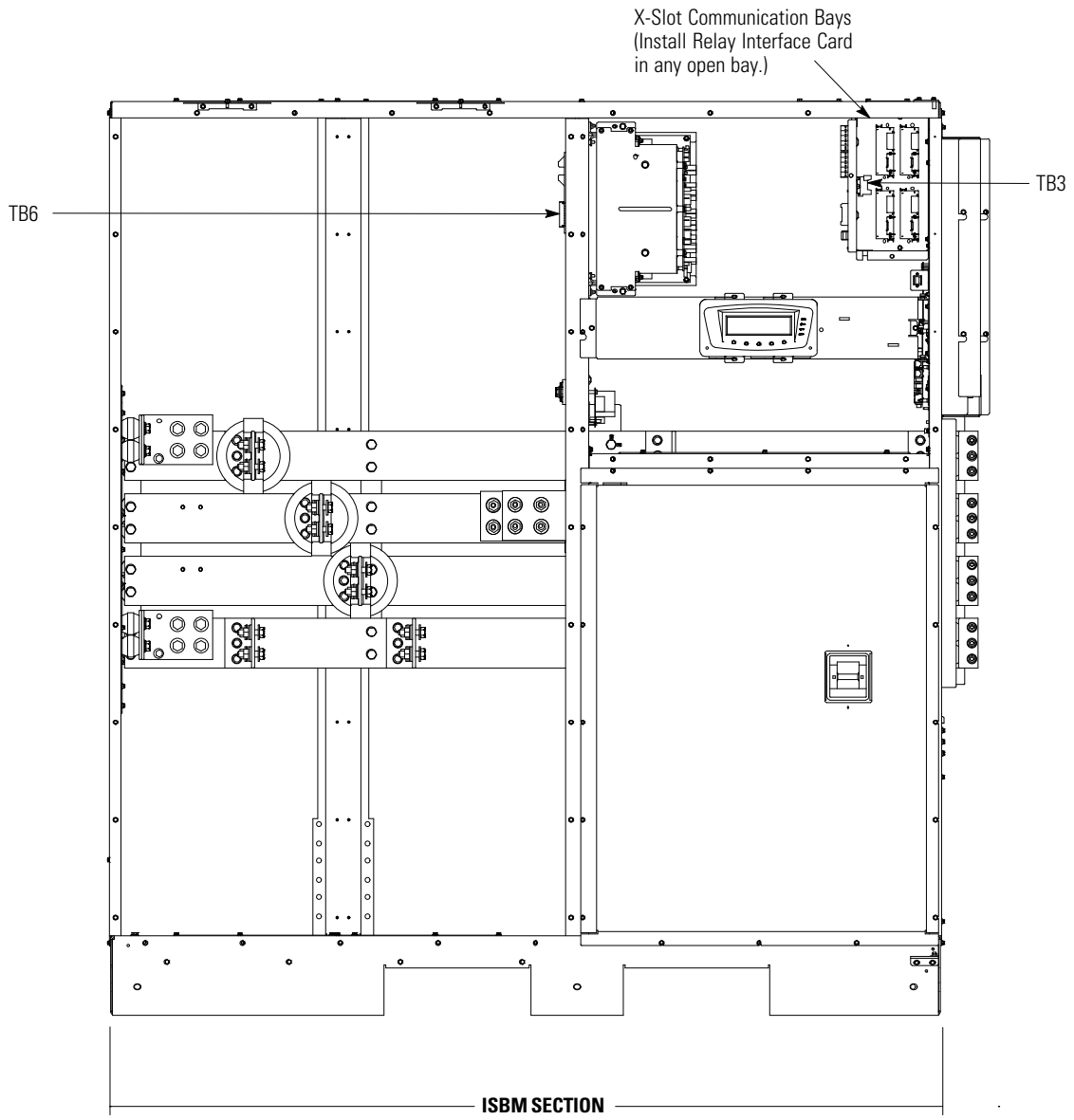

Figure 3-9. Eaton 9395 UPS and Plus 1 UPS (650–825 kVA) Interface Locations for Eaton Sync Control

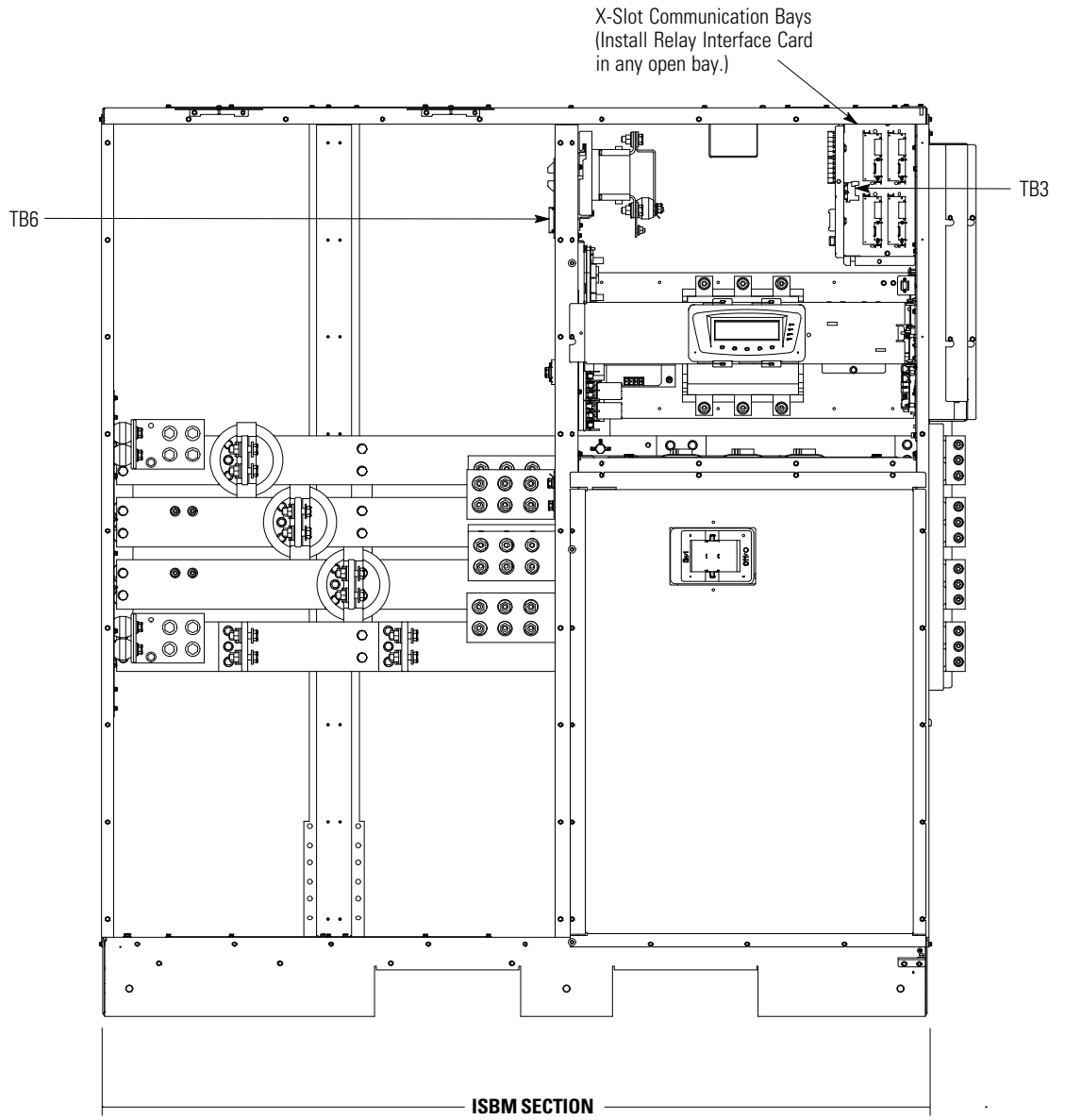

Figure 3-10. Eaton 9395 UPS (1000–1100 kVA) Interface Locations for Eaton Sync Control

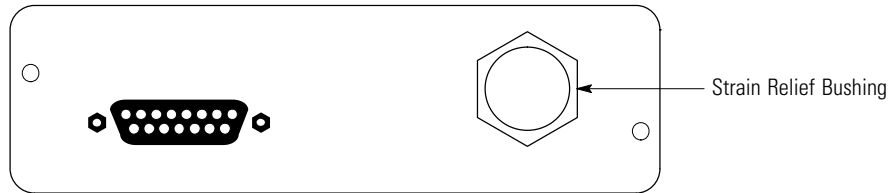

Figure 3-11. Relay Interface Card End View

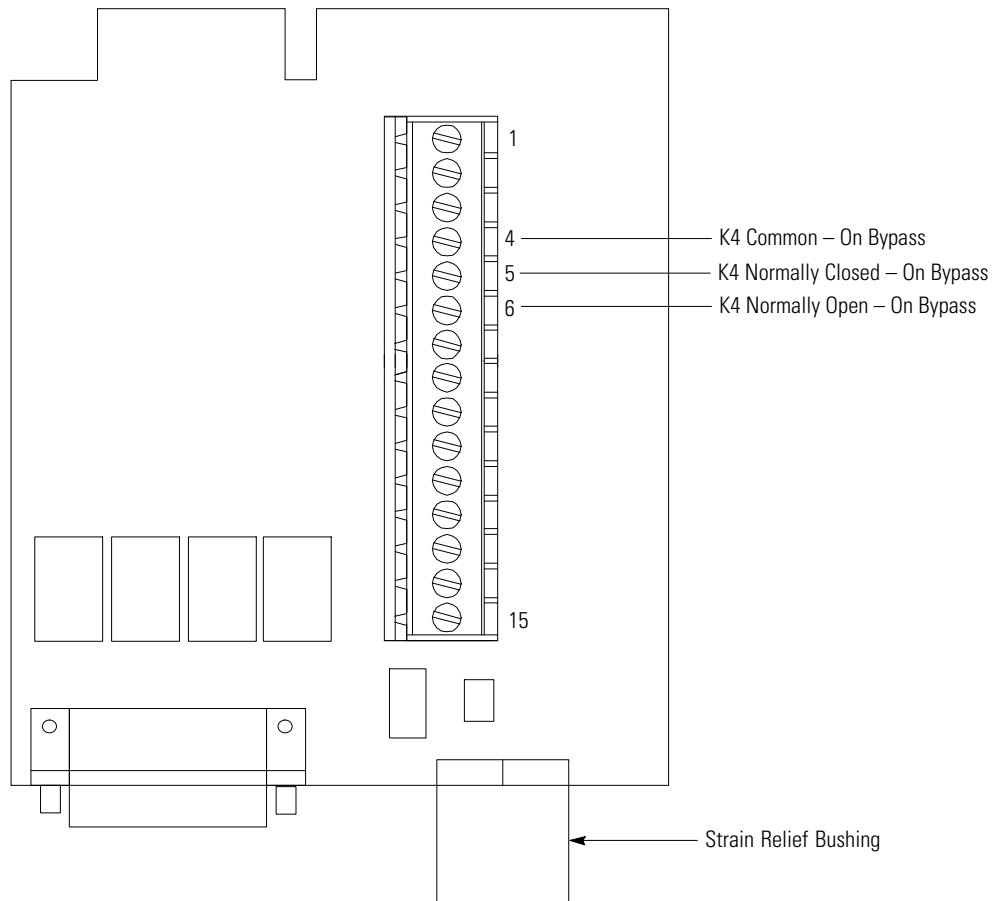

Figure 3-12. Relay Interface Card Terminals

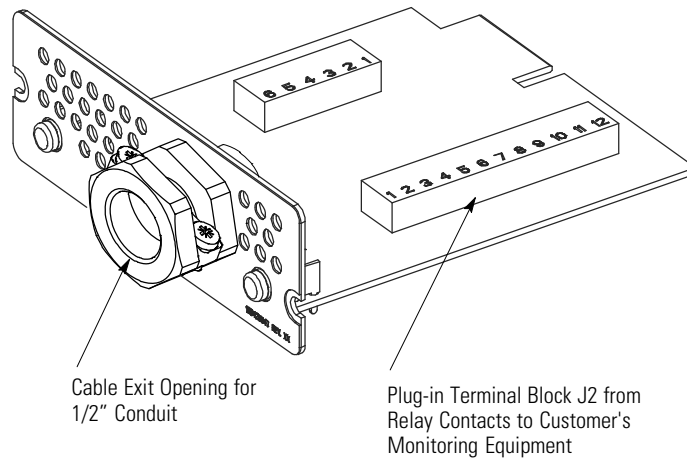

Figure 3-13. Industrial Relay Card

Table 3-3. IRC Wire Terminations

IRC Terminal	Function	Remarks
J2-1	NC	Normal Mode
J2-2	COM	
J2-3	NO	
J2-4	NC	Bypass Mode
J2-5	COM	
J2-6	NO	
J2-7	NC	Battery Mode
J2-8	COM	
J2-9	NO	
J2-10	NC	Alarm Mode
J2-11	COM	
J2-12	NO	

NOTE Maximum contact rating: 250 Vac, 30 Vdc @ 5A Wire Range: 16–24 AWG

3.3 Installation and Wiring with an Eaton 9395 SBM



NOTE When installing wiring connections, conduit must be installed between the Eaton Sync Control and the SBM cabinet.



NOTE The wiring information provided is for an SBM without the ESS option activated. The sync control becomes inactive when the ESS mode is activated on either or both SBMs.



NOTE For SSBM systems with Sync Control, wire from the first UPS TB6-1 to the SSBM TB3-11. See Figure 3-19 and Table 3-5.

To install and wire:

1. Install the Eaton Sync Control panel to the selected mounting location.

See Figure 2-1 on page 2-2 for mounting hole dimensions and Figure 2-2 on page 2-3 for conduit entrance locations.

2. Unfasten the front door latches and swing the door open.
3. Complete all control wiring interconnections using Table 3-4 for wiring requirements.

Figure 3-1 shows the Eaton Sync Control TB1 terminal block and ground terminal locations. Figure 3-2 shows the TB1 terminal block wiring detail.

Figure 3-14 shows the typical locations of the SSBM interconnect terminal blocks. Figure 3-5 shows the TB6 detail. Figure 3-15 through Figure 3-13 show terminal details.

Refer to the applicable Eaton 9395 SBM Installation and Operation Manual and 9395 SBM Installation and Operation Manual listed in paragraph 1.3 for cabinet terminal locations and assignments, termination requirements, conduit landing locations, and terminal access instructions.

4. Verify the jumper is installed between Sync Control terminal TB1-40 and TB1-41 (see Figure 3-2).
5. When all wiring is complete, close the door and secure the latch.

CAUTION



When connecting the bypass and load voltage from another model UPS to a Eaton 9395 SBM using the Eaton Sync Control accessory, use Phase A, Phase B, and Phase C connections from the other UPS. DO NOT connect the other model SBM Neutral bypass and load voltage to the Sync Control connection point when connecting to an Eaton 9395 SBM.

Table 3-4. Eaton 9395 SBM System Control Wiring Interconnections

From SSBM-A	To Sync Control	Function	Note
TB3-6	TB1-4	Bypass Voltage Phase A	14 AWG Twist Together
TB3-5	TB1-5	Bypass Voltage Phase B	
TB3-4	TB1-6	Bypass Voltage Phase C	
TB3-3	TB1-13	Output Voltage Phase A	14 AWG Twist Together
TB3-2	TB1-14	Output Voltage Phase B	
TB3-1	TB1-15	Output Voltage Phase C	
TB3-10	TB1-16	Bypass Voltage Phase A Return	14 AWG Twist Together
TB3-9	TB1-17	Bypass Voltage Phase B Return	
TB3-8	TB1-18	Bypass Voltage Phase C Return	
TB2-1	TB1-22	Transfer to Bypass Disable (24 Vdc)	14 AWG Twist Together
TB2-3	TB1-23	Transfer to Bypass Disable Return (24 Vdc)	
TB2-9*	TB1-26	Sync Control Trouble (24 Vdc) (Optional)	14 AWG Twist Together
TB2-11*	TB1-27	Sync Control Trouble Return (24 Vdc) (Optional)	
TB4-7	TB1-1	On Bypass Common	14 AWG Twist Together
TB4-8	TB1-2	On Bypass NO	
From SSBM-B	To Sync Control	Function	Note
TB3-6	TB1-10	Bypass Voltage Phase A	14 AWG Twist Together
TB3-5	TB1-11	Bypass Voltage Phase B	
TB3-4	TB1-12	Bypass Voltage Phase C	
TB3-3	TB1-7	Output Voltage Phase A	14 AWG Twist Together
TB3-2	TB1-8	Output Voltage Phase B	
TB3-1	TB1-9	Output Voltage Phase C	
TB3-10	TB1-19	Bypass Voltage Phase A Return	14 AWG Twist Together
TB3-9	TB1-20	Bypass Voltage Phase B Return	
TB3-8	TB1-21	Bypass Voltage Phase C Return	
TB2-1	TB1-24	Transfer to Bypass Disable (24 Vdc)	14 AWG Twist Together
TB2-3	TB1-25	Transfer to Bypass Disable Return (24 Vdc)	
TB2-9*	TB1-28	Sync Control Trouble (24 Vdc) (Optional)	14 AWG Twist Together
TB2-11*	TB1-29	Sync Control Trouble Return (24 Vdc) (Optional)	
TB4-7	TB1-1	On Bypass Common	14 AWG Twist Together
TB4-8	TB1-3	On Bypass NO	

* = building Alarm 3. On 9395 SBM screen set building Alarm 3 for "No Action Taken". The default setting for Building Alarm 3 is set for "Inverters Off".

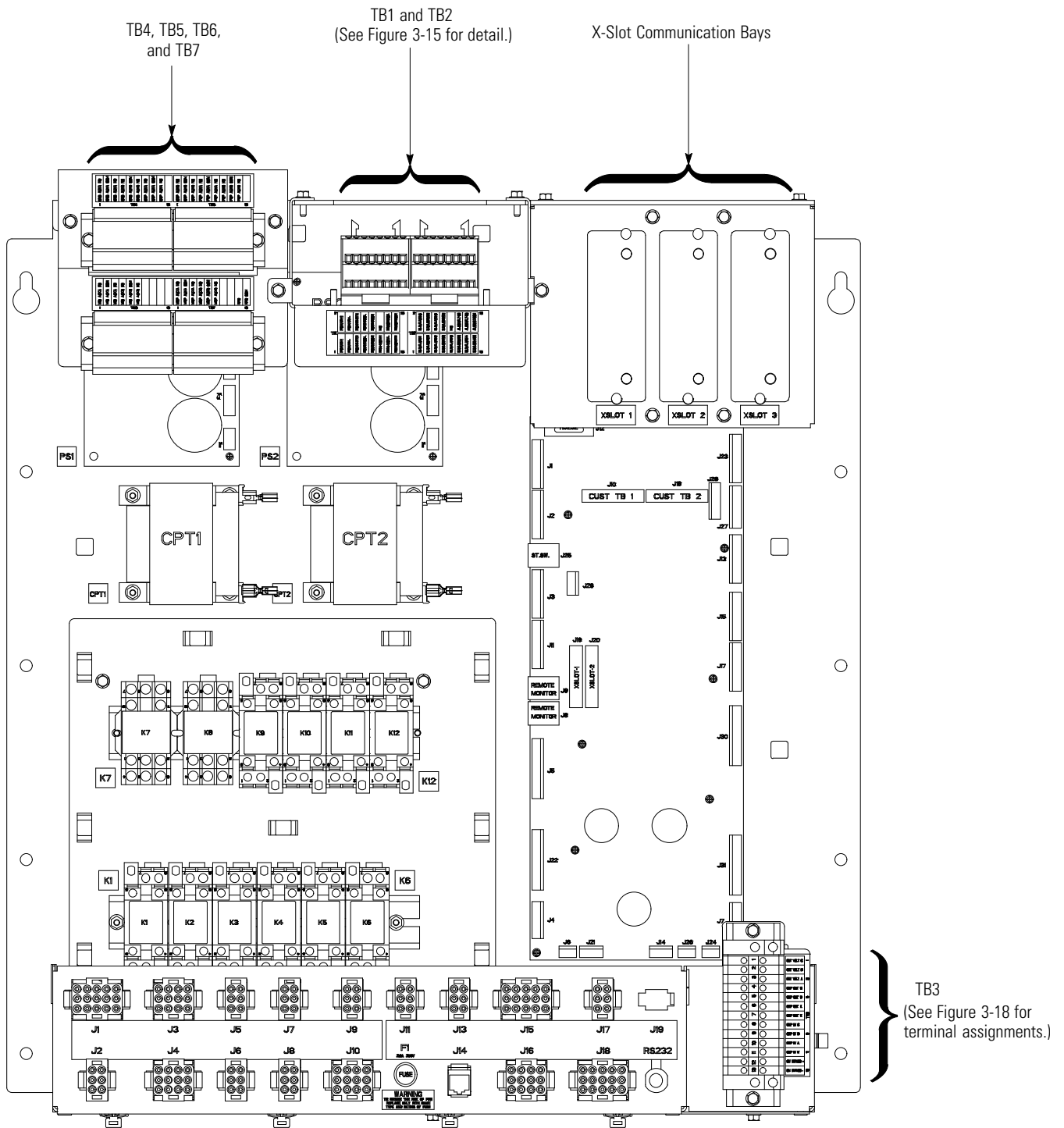

Figure 3-14. SBM Control Pan Interface Terminal Locations

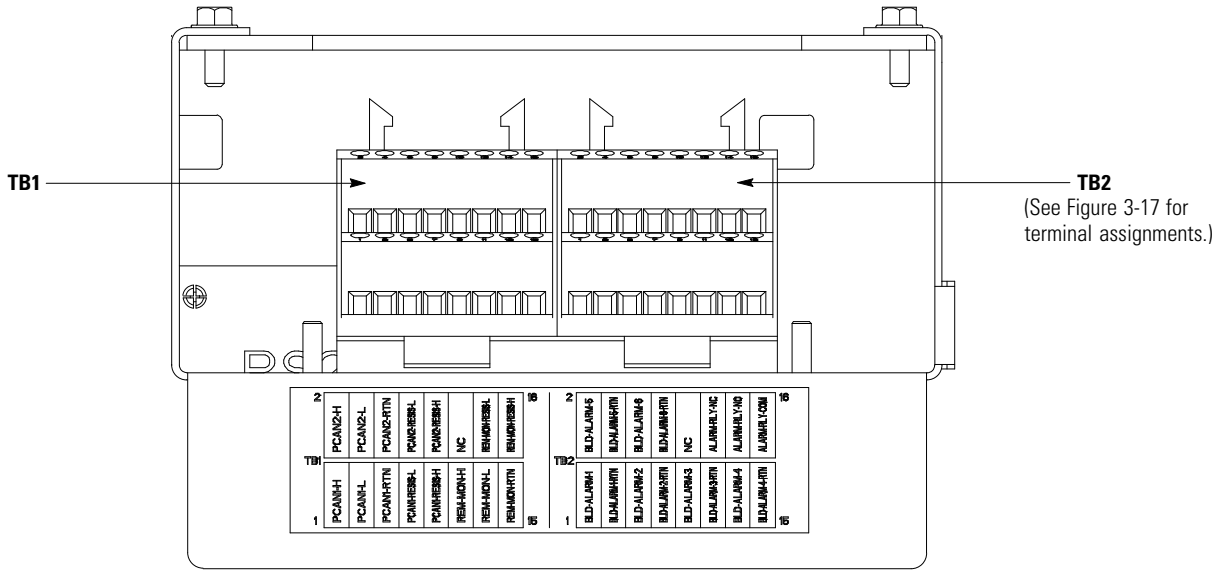

Figure 3-15. TB1 and TB2 Interface Terminal Detail

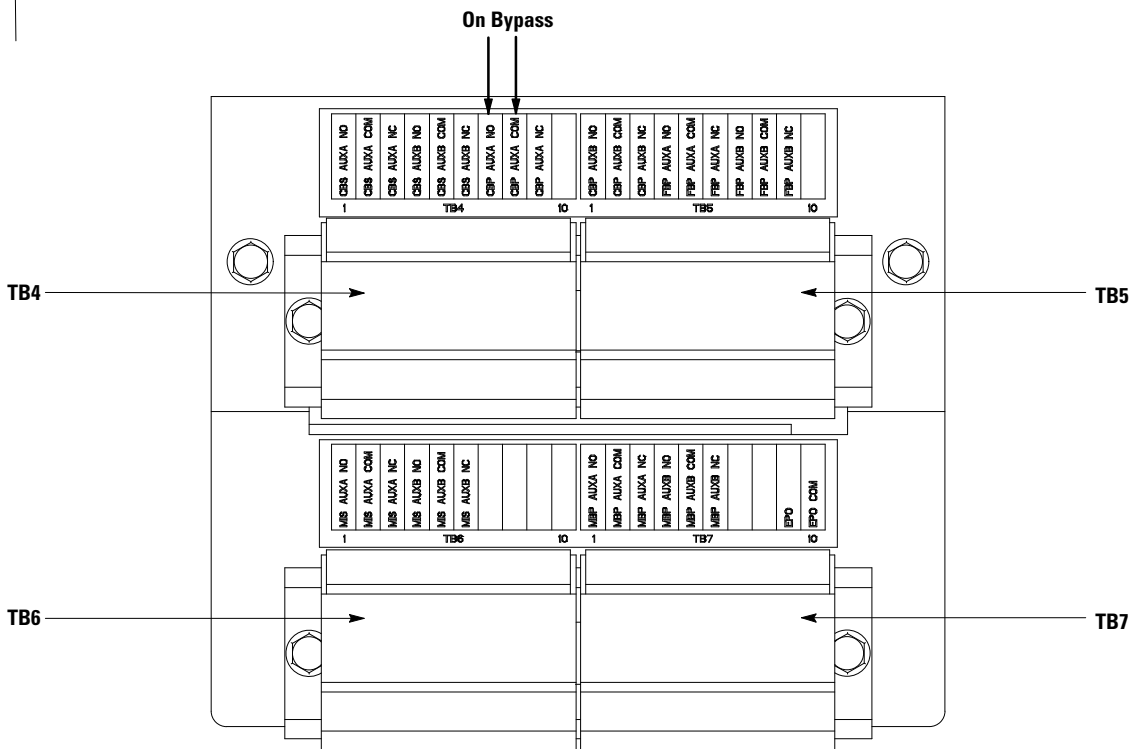

Figure 3-16. TB4 and TB5 Interface Terminal Detail

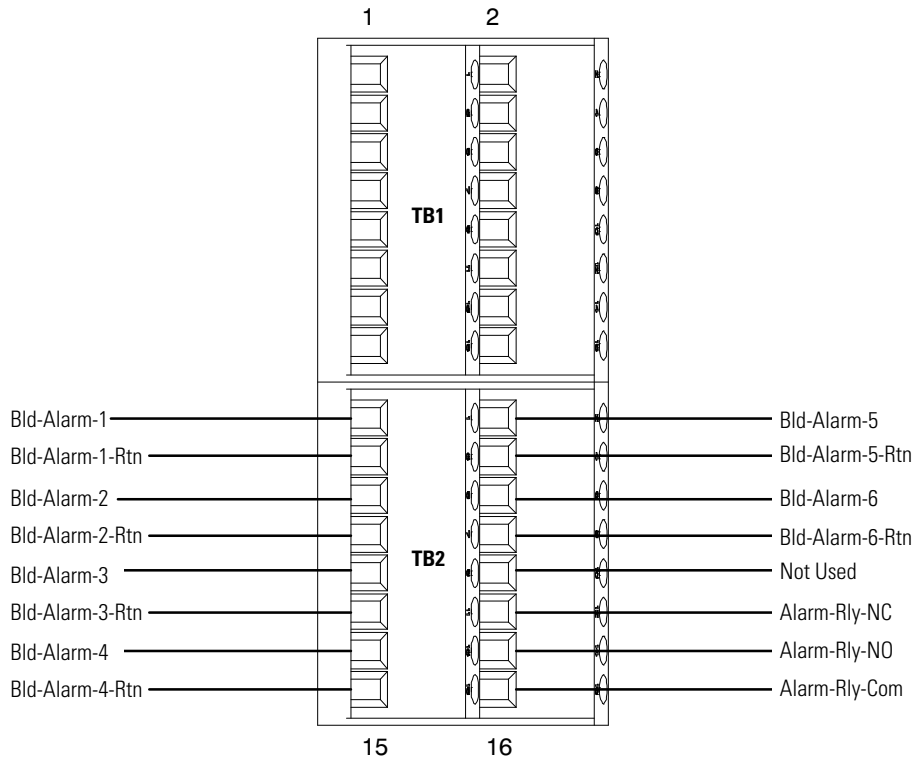
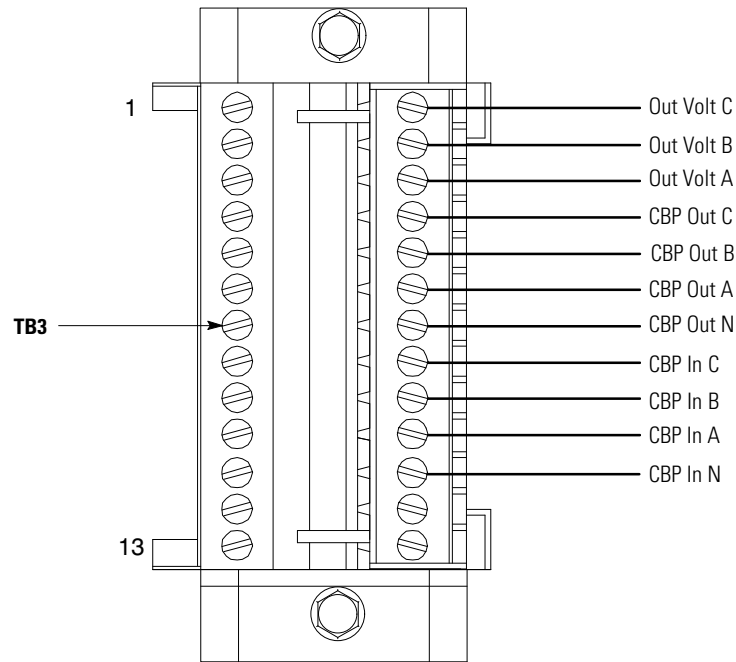

Figure 3-17. Terminal Block TB2 Connector Assignments



NOTE All building alarm inputs require an isolated normally-open or normally-closed contact or switch (rated at 24 Vdc, 20 mA minimum) connected between the alarm input and common terminal as shown. Building alarm inputs can be programmed for use with either normally-open or normally-closed contacts. All control wiring and relay and switch contacts are customer-supplied.

NOTE The building alarms can be programmed to display the alarm functional name.

Figure 3-18. Terminal Block TB3 Connector Assignments

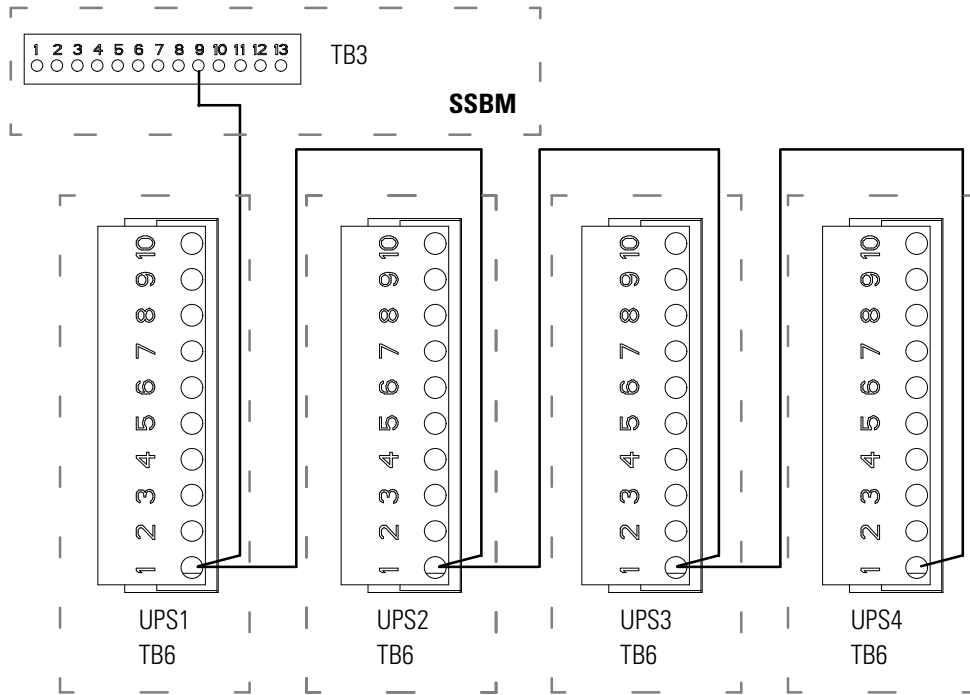

Figure 3-19. SBM to UPS Interconnection System Control Wiring

Table 3-5. Eaton 9395 SBM to UPS Interconnection System Control Wiring

From SSBM	To UPS #1	Function	Note
TB3-9	TB6-1	Bypass Voltage Phase B (480 Vac)	14 AWG (Twist Together)
From UPS #1	To UPS #2	Function	Note
TB6-1	TB6-1	Bypass Voltage Phase B (480 Vac)	14 AWG (Twist Together)
From UPS #2	To UPS #3	Function	Note
TB6-1	TB6-1	Bypass Voltage Phase B (480 Vac)	14 AWG (Twist Together)
From UPS #3	To UPS #4	Function	Note
TB6-1	TB6-1	Bypass Voltage Phase B (480 Vac)	14 AWG (Twist Together)

This page intentionally left blank.

This chapter describes the operation of the Eaton Sync Control with a UPS or SSBM system.

4.1 Startup for UPS Systems Equipped with an Eaton Sync Control

Startup and operational checks must be performed by an authorized Eaton Customer Service Engineer, or the warranty terms as specified on page 5-1 become void. This service is offered as part of the sales contract for the UPS. Contact service in advance (usually a two-week notice is required) to reserve a preferred startup date.

4.2 Understanding Eaton Sync Control Operation

The Eaton Sync Control maintains critical load synchronization of either two separate single Eaton 9390 UPS systems, two separate single Eaton 9395 UPS systems, or two separate 9395 SSBM systems. See Figure 4-1 for a typical block diagram of the system. Synchronization of the UPS systems facilitates the uninterrupted transfer of customer loads from one load bus to another by means of downstream, dual-source, solid-state transfer switches. Enable the automatic synchronization action of the Eaton Sync Control by pressing the LOAD SYNC ENABLE pushbutton on the front of the panel. When enabled, the LOAD SYNC ENABLE pushbutton illuminates.

The Eaton Sync Control panel provides a three-phase synchronization reference to each system. Each system uses this reference to regulate the inverter phase relationship so that the two system outputs can maintain synchronization with each other. To establish the three-phase synchronization reference, each system provides bypass sensing voltage and output (critical load) bus voltage to the Eaton Sync Control.

Under normal operating conditions, bypass sensing voltage from each system is provided back to its inverter through the Eaton Sync Control. As long as the two bypass sources feeding System-A and System-B are available and in phase, each system remains in synchronization with its own bypass source and the two systems remain in synchronization with each other. If the two bypass sources become out of phase with each other (>0.1 Hz apart) or one or both sources become unavailable, the Eaton Sync Control provides a new three-phase synchronization reference to the non-master system as determined by the PREFERRED SOURCE SELECTOR switch. The non-master system's new synchronization reference is provided by the Eaton Sync Control from the output (critical load) bus of the system designated as master by the PREFERRED SOURCE SELECTOR switch. See Figure 4-2 for a diagram of the synchronization reference control operation.

When the two bypass sources regain availability and synchronization, the Eaton Sync Control provides the non-master system with its own bypass sensing voltage as a synchronization reference. Before resynchronization occurs, a 15-second preset time delay ensures the two bypass sources maintain acceptable synchronization.

To maintain a fault-tolerant arrangement, the Eaton Sync Control accounts for the following fault conditions or abnormal operating conditions:

- An automatic reassignment of the preferred source (master) is made if the non-master system goes to bypass, regardless of the position of the PREFERRED SOURCE SELECTOR switch. When the non-master system (as defined by the PREFERRED SOURCE SELECTOR switch) is on bypass, the non-master system automatically becomes the master. The two systems continue to synchronize to their own bypass source until one of the bypass sources becomes unavailable or the two bypass sources are no longer in synchronization with each other.
- If one UPS/SSBM system loses its critical load bus voltage sensing, each system synchronizes to its own bypass source regardless of the position of the PREFERRED SOURCE SELECTOR switch.
- Dual redundant logic power supplies are incorporated within the Eaton Sync Control, ensuring both systems remain synchronized even during the loss of one of the logic power supplies. These power supplies are powered from each system's critical load bus.
- With a complete loss of logic power to the Eaton Sync Control (due to component failure or power supply fault), each system synchronizes to its own bypass source.
- (With optional Undervoltage relay) An automatic reassignment of the preferred source (master) is also made if the preferred source loses its bypass reference. When the master system (as defined by the PREFERRED SOURCE SELECTOR switch) loses its bypass reference, the non-master system automatically becomes the master allowing the other system to sync to a system with a good bypass.

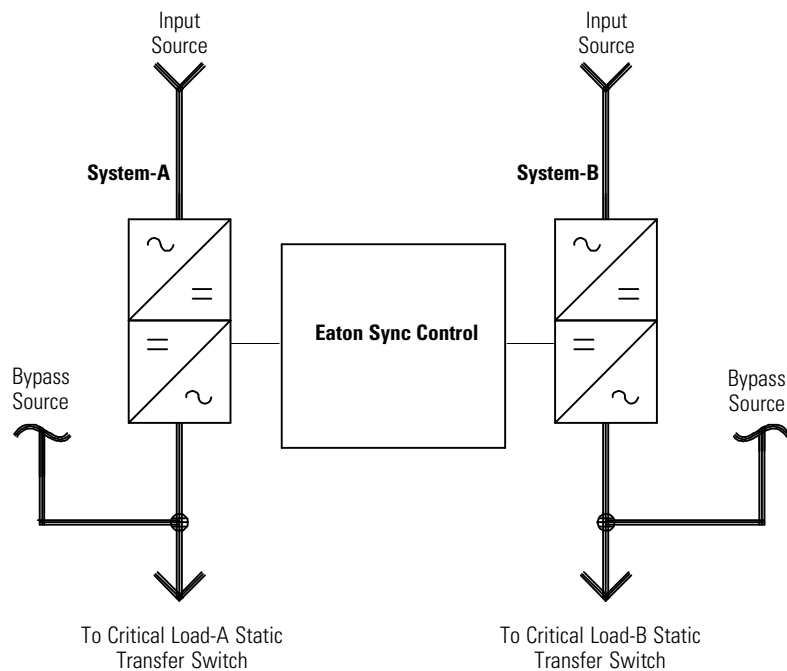
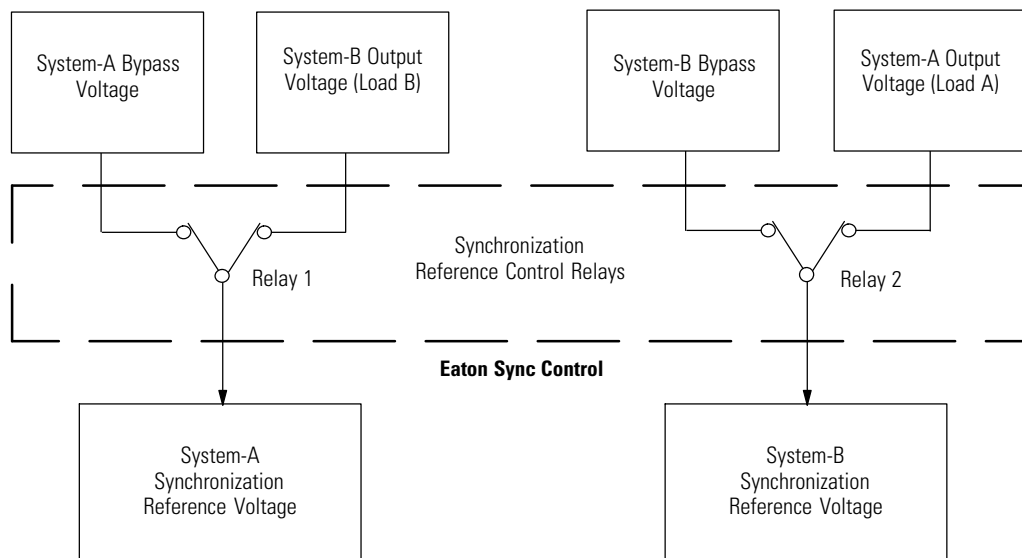

Figure 4-1. Typical Eaton Sync Control Block Diagram with a Eaton 9390 UPS, Eaton 9395 UPS, or 9395 SSBM.



NOTE The Synchronization Reference Control relays are shown under normal conditions. Both bypass sources are available and are in synchronization.

NOTE Dashed switch position of Synchronization Reference Control Relay 1 shows System-A in the non-master system mode.

NOTE Dashed switch position of Synchronization Reference Control Relay 2 shows System-B in the non-master system mode.

NOTE At any given time, only one of the UPS systems can be in the non-master system mode.

Figure 4-2. Synchronization Reference Control

4.3 Operation

Perform the following procedure to set up the Eaton Sync Control for operation with your system. See Figure 4-3 and Table 4-1 for the location and explanation of the controls and indicators on the Eaton Sync Control.

1. Place both UPS systems in normal operating mode. Refer to the applicable Eaton 9390 UPS or Eaton 9395 UPS installation and operation manual listed in paragraph 1.3.
2. Press the LAMP TEST pushbutton to verify all indicators illuminate and are working correctly.
3. Determine which system load bus (A or B) will be used as the master synchronization source. Set the PREFERRED SOURCE SELECTOR switch to this load bus.



NOTE If either of the yellow SYNCHRONIZED TO LOAD indicators are illuminated, the PREFERRED SOURCE SELECTOR switch is locked out and the master synchronization source cannot be changed.

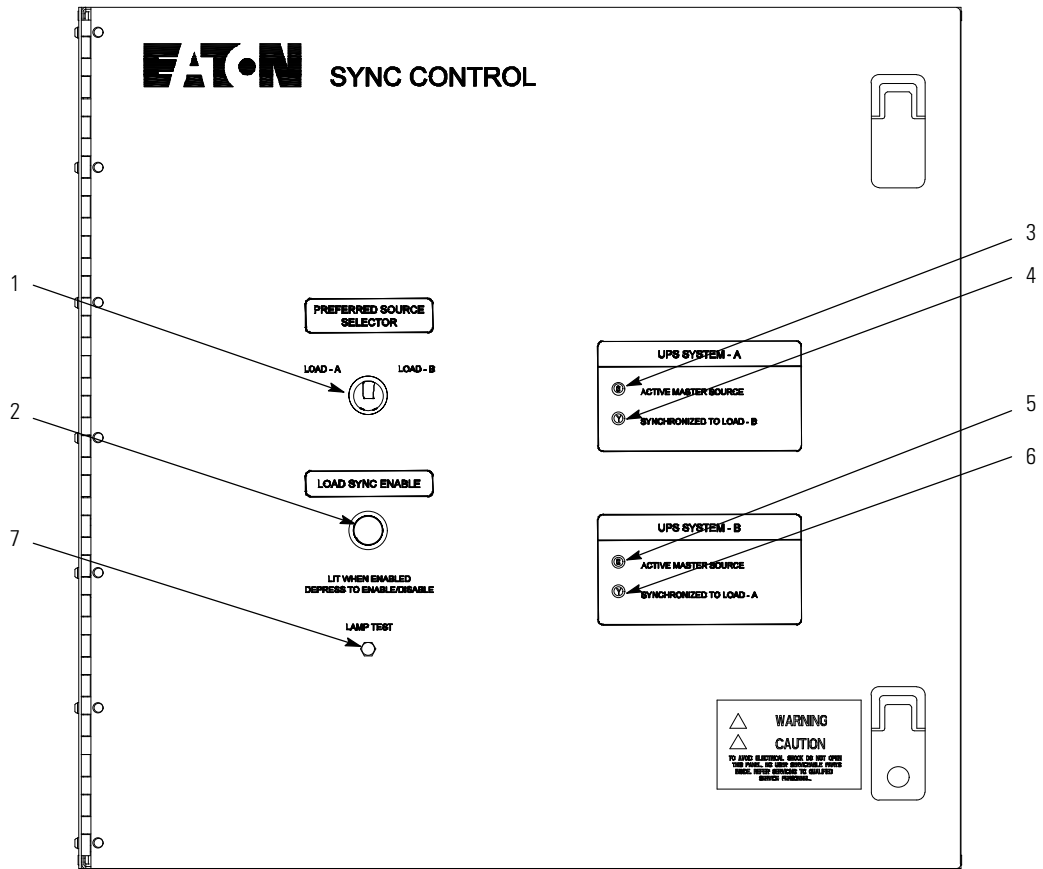

Figure 4-3. Eaton Sync Control Controls and Indicators

Table 4-1. Controls and Indicators

Item	Name	Function and Description
1	PREFERRED SOURCE SELECTOR	Two-position rotary switch allowing either of the two system load buses to be assigned as the master sync source.
2	LOAD SYNC ENABLE	Enables or disables the automatic Eaton Sync Control unit. Switch is illuminated when load sync action is enabled.
3	UPS SYSTEM-A ACTIVE MASTER SOURCE	When illuminated, indicates UPS System-A is the active master source. This indicator may illuminate even if the PREFERRED SOURCE SELECTOR switch is not set to the corresponding position.
4	UPS SYSTEM-A SYNCHRONIZED TO LOAD-B	When illuminated, indicates that UPS System-A is in the non-master system mode and is synchronized to the UPS System-B load bus.
5	UPS SYSTEM-B ACTIVE MASTER SOURCE	When illuminated, indicates UPS System-B is the active master source. This indicator may illuminate even if the PREFERRED SOURCE SELECTOR switch is not set to the corresponding position.
6	UPS SYSTEM-B SYNCHRONIZED TO LOAD-A	When illuminated, indicates that UPS System-B is in the non-master system mode and is synchronized to the UPS System-A load bus.
7	LAMP TEST	Pressing the pushbutton illuminates all indicators on the Eaton Sync Control unit for visual testing.

4. Press the LOAD SYNC ENABLE pushbutton to enable the automatic synchronization control. The pushbutton illuminates when the synchronization control is enabled.



NOTE If both systems are operating normally, the ACTIVE MASTER SOURCE green indicator illuminates for the selected master synchronization source.

NOTE If one system is in bypass, the ACTIVE MASTER SOURCE green indicator illuminates for the system in bypass, regardless of the position of the PREFERRED SOURCE SELECTOR switch.

NOTE If one or both of the systems lose their bypass sources or if the bypass sources are no longer in synchronization, the yellow SYNCHRONIZED TO LOAD indicator illuminates for the non-master system.

5. To disable the automatic synchronization control, press the LOAD SYNC ENABLE pushbutton and verify that the indicators, including the LOAD SYNC ENABLE pushbutton, are off.

4.4 Maintenance Operations

Maintenance should be scheduled on a periodic basis, recommended not to exceed one year. More frequent intervals are recommended if the equipment is subjected to highly repetitive operations.

DANGER



This UPS contains **LETHAL VOLTAGES**. All repairs and service should be performed by **AUTHORIZED SERVICE PERSONNEL ONLY**. There are **NO USER SERVICEABLE PARTS** inside the UPS.

Periodic inspections of the Eaton Sync Control should be made to determine if components, wiring, and connections exhibit evidence of overheating or damage.

CAUTION



Refer to the maintenance chapter in the applicable Eaton 9390 UPS, Eaton 9395 UPS or 9395 SSBM Installation and Operation Manual listed in paragraph 1.3 before beginning maintenance or repairs.

This page intentionally left blank.

Chapter 5

Warranty

LIMITED FACTORY WARRANTY FOR EATON THREE-PHASE UPS PRODUCTS

WARRANTOR: The warrantor for the limited warranties set forth herein is Eaton Corporation, an Ohio Corporation (“Eaton”).

LIMITED WARRANTY: This limited warranty (this “Warranty”) applies only to the original end-user (the “End-User”) of the Eaton Three-Phase UPS Products (the “Product”) and cannot be transferred. This Warranty applies even in the event that the Product is initially sold by Eaton for resale to an End-User.

LIMITED WARRANTY PERIOD: The period covered by this Warranty for Product installed [and currently located] in the fifty (50) United States and the District of Columbia is twelve (12) months from the date of Product start-up or eighteen (18) months from the date of Product shipment, whichever occurs first, for parts coverage and 90 days from the date of Product start-up for labor coverage. The period covered by this Warranty for Product installed [and currently located] outside of the fifty (50) United States and the District of Columbia is twelve (12) months from the date of Product start-up or eighteen (18) months from the date of Product shipment, whichever occurs first, for parts coverage.

WHAT THIS LIMITED WARRANTY COVERS: The warrantor warrants that the Eaton three-phase UPS electronics, Eaton-built accessories, and Eaton-built battery cabinets (individually and collectively, the “Warranted Items”) are free from defects in material and workmanship. If, in the opinion of Eaton, a Warranted Item is defective and the defect is within the terms of this Warranty, Eaton’s sole obligation will be to repair or replace such defective item (including by providing service, parts, and labor, as applicable), at the option of Eaton. The Warranted Item will be repaired or replaced onsite at the End-User’s location or such other location as determined by Eaton. Any parts that are replaced may be new or reconditioned. All parts replaced by Eaton shall become the property of Eaton.

WHAT THIS LIMITED WARRANTY DOES NOT COVER: This Warranty does not cover any defects or damages caused by: (a) failure to properly store the Product before installation, including the “trickle charge” of batteries no later than the date indicated on the packaging; (b) shipping and delivery of the Product if shipping is FOB Factory; (c) neglect, accident, fire, flood, lightning, vandalism, acts of God, Customer’s neglect, abuse, misuse, misapplication, incorrect installation; (d) repair or alteration not authorized in writing by Eaton personnel or performed by an authorized Eaton Customer Service Engineer or Agent; or (e) improper testing, operation, maintenance, adjustment, or any modification of any kind not authorized in writing by Eaton personnel or performed by an authorized Eaton Customer Service Engineer or Agent.

This Warranty is not valid: (a) unless an authorized Eaton Customer Service Engineer (in the USA) or Agent (outside of the USA) performs startup and commissioning of the Product; (b) if the Product is moved to a new location by someone other than an authorized Eaton Customer Service Engineer (in the USA) or Agent (outside of the USA); or (c) if the Product’s serial numbers have been removed or are illegible. Any Warranted Items repaired or replaced pursuant to this Warranty will be warranted for the remaining portion of the original Warranty subject to all the terms thereof. Labor warranty is not provided for Product located outside of the fifty (50) United States or the District of Columbia. Any equipment, parts, or materials included in the Product and not manufactured by Eaton are warranted solely by the manufacturer of such equipment, parts, or materials and are not included as part of this Warranty. Batteries are not warranted by Eaton.

THIS WARRANTY IS THE END-USER’S SOLE REMEDY AND IS EXPRESSLY IN LIEU OF, AND THERE ARE NO OTHER EXPRESSED OR IMPLIED GUARANTEES OR WARRANTIES (INCLUDING ANY IMPLIED WARRANTY OF MERCHANTABILITY OR FITNESS FOR ANY PURPOSE, WHICH ARE EXPRESSLY DISCLAIMED).

LIMITATION OF LIABILITY: In no event shall Eaton be liable for any indirect, incidental, special, or consequential damages of any kind or type whatsoever, or based on any claim or cause of action, however denominated. Eaton shall not be responsible for failure to provide service or parts due to causes beyond Eaton’s reasonable control. In no case will Eaton’s liability under this Warranty exceed the replacement value of the Warranted Items.

END-USER’S OBLIGATIONS: In order to receive the benefits of this Warranty, the End-User must use the Product in a normal way, follow the Product’s installation, operation and maintenance manual, and protect against further damage to the Product if there is a covered defect.

OTHER LIMITATIONS: Eaton’s obligations under this Warranty are expressly conditioned upon receipt by Eaton of all payments due to it (including interest charges, if any). During such time as Eaton has not received payment of any amount due to it for the Product, in accordance with the contract terms under which the Product is sold, Eaton shall have no obligation under this Warranty. Also during such time, the period of this Warranty shall continue to run and the expiration of this Warranty shall not be extended upon payment of any overdue or unpaid amounts.

COSTS NOT RELATED TO WARRANTY: The End-User shall be invoiced for, and shall pay for, all services not expressly provided for by the terms of this Warranty, including without limitation site calls involving an inspection that determines no corrective maintenance is required. Any costs for replacement equipment, installation, materials, freight charges, travel expenses, or labor of Eaton representatives outside the terms of this Warranty will be borne by the End-User.

OBTAINING WARRANTY SERVICE: In the USA, call the Eaton Customer Reliability Center 7x24 at 800-843-9433. Outside of the USA, call your local Eaton sales or service representative, or call the Eaton Customer Reliability Center in the USA at 919-870-3028. For comments or questions about this Limited Factory Warranty, write to the Customer Quality Representative, 3301 Spring Forest Road, Raleigh, North Carolina 27616 USA.

This page intentionally left blank.



P-164000052 2