



ИБП Eaton Powerware 9305 80кВА - Powerware 9305 (7.5-80 кВА) - Брошюра

Постоянная ссылка на страницу: <https://eaton-power.ru/catalog/powerware-9305-40-80-kva/powerware-9305->

Powerware 9305 7.5 kVA - 80 kVA



Reliable power with proven double conversion online technology

The transformerless Powerware 9305, a Series 9 UPS, is designed for heavy-duty use in centralised computer and server rooms, Internet and telecommunication centres, building and process automation rooms and in many marine, defence, banking and hospital systems.

Why is power protection so important?

Even the most advanced computer systems are very sensitive to disturbances in their power supplies. Did you know that as much as 45% of data loss in unprotected systems are caused by bad power? All those network crashes, mysterious error messages, damaged files and other anomalies bog your system down and take hours to be fixed.

The Powerware 9305 protects against all nine power problems: power failures, sags, surges, undervoltage, line noise, overvoltage, frequency variation, switching transients and harmonic distortion. It prevents network and file damage as well as component stress, burned circuit boards, data crash and program failures.

Make power protection easy and efficient

A centralised Powerware 9305 is the most economical way of protecting equipment set-ups that are located near each other. The PW9305 also makes the IT manager's life a lot easier as it is fully configurable either locally or remotely. And because there is just one unit, maintenance is easy to do.

The PW9305 allows the addition of new equipment to the load later if it has been dimensioned for upgrades. By far the most convenient power solution for scalable systems is the parallel configuration. The PW 9305 can be used in parallel configurations of up to four UPS modules, bringing the power range up to 320 kVA thanks to the four 80 kVA modules. Paralleling the UPSs makes systems easily scalable. You can achieve redundancy at the same time by adding one UPS module more than required to support the critical load.

Patented Hot Sync™ technology provides parallel redundancy and scalable power protection up to 320 kVA



What is the suitable configuration for my needs?

Depending on your needs, you can choose from several alternative configurations. The basic single line diagrams of these configurations are presented on this page.

Standard system

A single UPS unit capable of supplying power to the critical load. The critical load is transferred to the bypass source via the static switch if the unit fails or the load becomes too great. A mechanical bypass switch is used for maintenance purposes.

Standard system

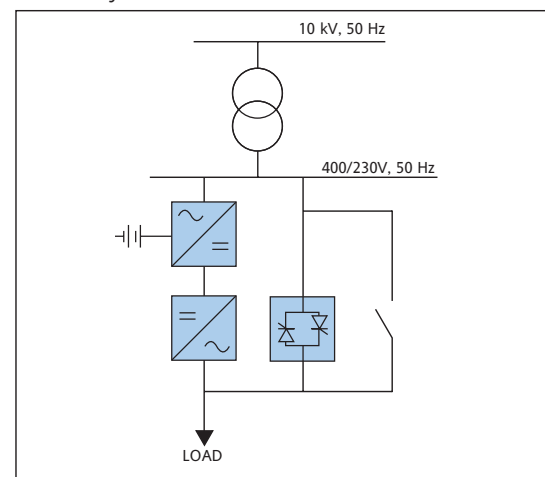

Hot Standby system

When the criticality of your load is greater, you can opt for two single UPS units with a special connection to increase power availability. The critical load is powered by the first UPS unit. In case of failure, the critical load is transferred to the bypass source that is supplied by the second unit. This configuration enables redundant operation with standard UPS units.

Hot Standby system

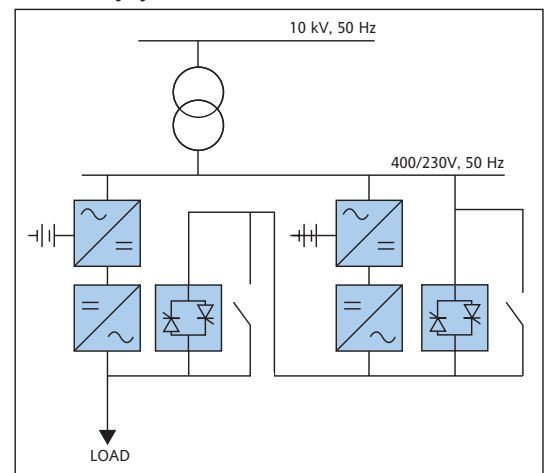

Hot Sync™ Redundancy or Capacity

Hot Sync™ redundancy is N+1 module system for the most critical applications and allowing full maintenance to be performed on a single module without the need for an external maintenance bypass switch. The critical load never needs to be removed from conditioned power.

Hot Sync™ Capacity can accommodate up to four modules in parallel for the most maximum output power. Hot Sync™ redundancy can be easily switched Hot Sync™ Capacity as the power requirement grows and there is no time to wait the redundant upgrade module.

Hot Sync™ Redundancy or Capacity

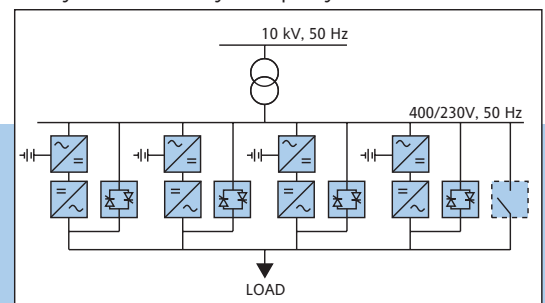

Advanced features that give you operational and business benefits

The Powerware 9305 widely covers the needs of power protection in many applications that rely on continuous, conditioned power. In true Powerware style, it also sports features that make operation and maintenance a breeze.

Advanced Battery Management™

UPS systems have a maintenance free lead-acid battery solution that is both critical and expensive for the user. The expected lifetime of batteries is also shorter compared to the rest of the UPS system. Therefore, one should pay close attention to the right battery solution with advanced charging technology.

Today, virtually all competitive UPS products on the market have VRLA batteries with traditional float charging technology. ABM™ is different because of the three-stage charging technique that constantly monitors the battery charging status and recharges only when necessary. In result the internal battery corrosion is reduced dramatically to provide 50% longer battery life time compared to the float charging technology.

Powerware Hot Sync™ Technology

The absolute reliability of UPS system can be increased close to 100% with the US patented Hot Sync™ parallel load sharing technology. It is designed for parallel redundant N+1 systems to satisfy the 7/24h applications. The Hot Sync™ can also be used in parallel capacity systems to benefit from the scalability for customer's ever-increasing load demands.

Competitive UPS products on the market utilize centralised or distributed load sharing technology with master-slave principle. The Hot Sync™ erases the single point of failure logic within the traditional load sharing systems because of the ability to synchronise and support the critical load independently of the other UPS modules. The UPS modules can share a critical load even without any communication wiring to outside world.

Moreover, the Hot Sync™ technology allows full maintenance to be performed one-by-one on redundant UPS modules without the external maintenance bypass switch. The critical load needs not to be removed from the conditioned power. Scheduled or unscheduled maintenance needs can be performed with the critical load supported constantly by the UPS grade clean power.

Efficiency Optimiser™

In standard system, the high efficiency mode can be activated by the operator. It forces PW9305 to use the bypass source when the mains power quality is acceptable for the load. The unit UPS transfers to double conversion or battery mode if a serious power problem threatens the load. In consequence, the Efficiency Optimiser™ cuts down the electrical bill by minimising power losses.

ABM™ with the intermittent charging method

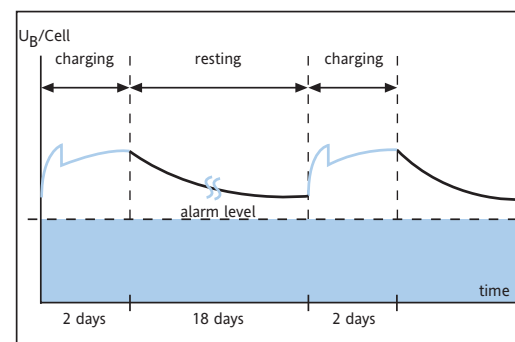

ABM™ guarantees low battery corrosion and long life time

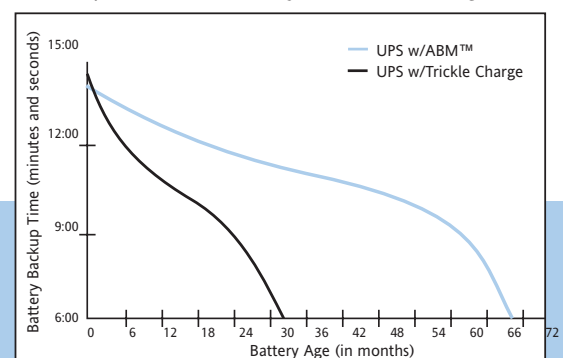

Communication for better protection

The PW9305 provides a wide range of communication options regardless of how simple or complex your needs may be. It displays information in a variety of formats from LEDs to a network or mainframe notification.

Software Suite

is bundled with all 9305 UPSes. The SW Suite includes all current Powerware SW products

- LanSafe for network shutdown
- OnliNet Centro for SNMP shutdown
- OnliNet Vista for basic monitoring
- PowerVision for advanced UPS monitoring and performance analysis (30 days trial period)

The Software Suite CD-ROM also includes demos, brochures, documentation and videos. The Suite's intuitive wizards make it easy to choose and install the right software for each application.



ConnectUPS™ SNMP/WEB Adapter

When the PW9305 is located away from the equipment it protects, connectivity devices have to be used for communication with computers and monitoring/management platforms. The PW9305 communicates over the network through an external ConnectUPS-E adapter plugged direct into the unit. The ConnectUPS adapters easily integrate with SNMP-compatible network management solutions, such as HP OpenView, CA Unicenter, IBM Tivoli NetView and many others.



Powerware's OnliNet Centro SNMP shutdown software

collects the relevant data from the UPS over the network and, if necessary, automatically shuts down the computers protected by the 9305 in an orderly fashion.

- Compatible with leading SNMP network management software (NMS) packages and Powerware's OnliNet Centro and OnliNet Vista
- Automatically records UPS events and alarms in an event/history log
- Supports Powerware's PowerMIB and UPS Standard MIB (RFC 1628)
- Supports SNMP V1 protocol
- Available for 10BaseT Ethernet (10 Mbps Twisted pair) applications
- Configurable over the network from a remote location via BOOTP

Feature	Benefit
Double conversion topology	Non-stop perfect power for the load. The right solution for any 24/7 mission-critical application.
ABM™	Reduces battery corrosion and gives 50% longer battery lifetimes compared to traditional trickle charging methods.
Hot Sync™ paralleling technology	Allows parallel operation of up to four UPS units, bringing system availability close to 100%.
Transformerless UPS design with 3-phase bypass	Easy to move and install anywhere thanks to its light weight. Provides balanced loading of the mains in bypass mode.
Wide input voltage and frequency window	Less need for battery operation —longer battery life time. Battery is kept fully charged at all times —increased reliability
Supports continuous 100 % unbalanced loading	Flexibility, loads can be started and loading stopped without minding their balancing.
Frequency 50/60 Hz, selectable	Frequency conversion possibility.
Input power factor 0.96	Small input fuses, inexpensive installation.
Battery start	Can be cold-started without mains power.

Accessories to enhance productivity

The Powerware 9305 can be complemented by a number of accessories which enable you to extend its backup time or enhance its operation.

System Parallel Module (SPM)

is a floor-mounted, enclosed cabinet for parallel UPS systems supplying critical loads. It provides a tie connection for up to four UPS modules. The System Parallel Module includes four maintenance disconnect switches and a system bypass switch for easy servicing.

Input filter

The function of the intelligent input filter is to provide an alternate path for specified harmonic currents. The PW9305's input filter cabinet contains both 3rd and 5th harmonic filters. The filter reduces the input current distortion to 10% THD level. The filter is used in weak networks, such as generator-supplied networks, to avoid overdimensioning due to high harmonic currents.

ViewUPS remote control panel

is an LCD display that allows monitoring the PW9305 within a 50-metre radius of the unit. This external panel can be free-standing or mounted on a wall. It is operated by four function buttons on the faceplate, giving you information of the UPS type and status, performance measurements and alarms. You can also use it to set UPS parameters or to reset the unit. The display allows selection of English, German, Swedish or Finnish as user languages.



ViewUPS for remote monitoring and configuration

Isolation transformer

creates full galvanic isolation between mains input and the load. It protects against common mode noise and transients on the mains supply. The transformer is connected to the UPS input or output. It isolates the load from utility power during normal and bypass mode operation.

Various battery options

Standard VRLA batteries enable backup times of up to several hours. The Powerware 9305 is also designed to operate with open cell and NiCd batteries. These are offered as engineered projects. Battery installation options include open racks and battery cabinets to blend in with the UPS unit. High-capacity battery chargers are available.

Vibration absorbers and floor anchoring kits

In many cases the standard installation solution is sufficient without any changes at all. Typically, modifications are needed in marine and offshore applications where the environment is more demanding than in land-based installations.



Vibration absorbers and floor anchoring kits are available for demanding conditions

Technical specifications



Rating	7.5 kVA	10 kVA	15 kVA			
Part number	PW9305-7.5I-N	PW9305-10I-N	PW9305-15I-N			
Capacity (VA/Watts)	7.5 / 5.25	10 / 7	15 / 10.5			
Dimensions WxDxH (mm)	400x750x700	400x750x700	400x750x700			
Weight (kg)	180	180	220			
Input connection	Hardwired	Hardwired	Hardwired			
Output connection	Hardwired	Hardwired	Hardwired			
Typical runtime (Full load)	18 min	14 min	7 min			
(Half load)	40 min	30 min	18 min			
Rating	20 kVA	30 kVA	40 kVA	50 kVA	60 kVA	80 kVA
Part number	PW9305-20I-N	PW9305-30I-N	PW9305-40I-NX	PW9305-50I-N	PW9305-60I-N	PW9305-80I-N
Capacity (VA/Watts)	20 kVA/14 kW	30 kVA/21 kW	40 kVA/28 kW	50 kVA/35 kW	60 kVA/42 kW	80 kVA/56 kW
Dimensions WxDxH (mm)	520x788x1530	520x788x1530	520x788x1530	520x788x1530	520x788x1530	520x788x1530
Weight (kg)	400	490	230	260	260	280
Input connection	Hardwired	Hardwired	Hardwired	Hardwired	Hardwired	Hardwired
Output connection	Hardwired	Hardwired	Hardwired	Hardwired	Hardwired	Hardwired
Typical runtime (Full load)	12 min	7 min	10 min (ext. bat)	7 min (ext. bat)	10 min (ext. bat)	12 min (ext. bat)
(Half load)	30 min	18 min	25 min	20 min	28 min	30 min
Operational						
Nominal input voltage (VAC)	220/380, 230/400, 240/415 VAC three-phase					
Input voltage range	170/294 to 279/484 VAC (7.5/10/15 kVA); 170/294 to 275/476 VAC (20/30 kVA); 170/294 to 279/484 VAC (40/50 kVA); 180/312 to 279/484 VAC (60 kVA);					
Operating frequency	50/60 Hz (45 to 65 Hz)					
Input power factor	0.96					
Input current distortion	10% THDi with input filter					
Nominal output voltage	220/380, 230/400, 240/415 VAC three-phase					
Output voltage regulation	±1% static, 100% unbalanced load accepted; ±5% dynamic at 100% load change, <1 ms recovery time					
Overload capacity	101-110% for 10 min (online); 111-125% for 1 min (online); 126-150% for 30 sec (online); 150-170% for 5 sec (online); 1000% for one cycle (bypass)					
Efficiency	93-94% with rated non-linear load; 97% with Efficiency Optimizer™					
User interface						
LCD display	Multilingual LCD display showing measurements of performance and alarms (ViewUPS optional with 7.5/10/15 kVA models)					
LED	UPS On, On battery, On bypass, Alarm (7.5/10/15 kVA models also On line, Overtemperature, Service; additionally 4 LEDs for load bar and overload)					
Standard communication ports	2xRS232 for local support, one with modem support; 4xrelay contacts: UPS OK/Alarm, Line failure, Low battery, UPS bypassed; 4xprogrammable inputs: Generator on, External bypass, Inverter on/off, Environment alarm; 1xEmergency power off input					
Optional	20/30/40/50/60 kVA models: Parallel capacity/redundancy systems (max. 4 modules), External battery cabinets and high capacity charger; Output transformer; Input 10% THD filter; Remote ViewUPS (LCD display); ConnectUPS (SNMP adapter); LanQuattro (4xRS232 data manager) 7.5/10/15 kVA models: Parallel redundancy systems (max 2 modules), External battery cabinets and high capacity charger, Output transformer, Input 10% THD filter, ViewUPS (LCD display), ConnectUPS (SNMP adapter), LanQuattro (4xRS232 data manager)					
Environmental						
Operating temperature	0°C to +40°C					
Storage temperature	-25°C to +40°C					
Altitude	<1000 m					
Audible noise at 1 metre	50 dB (7.5/10/15 kVA) 55 dB (20/30 kVA) 60 dB (40/50/60 kVA)					
Certification						
Quality System	ISO 9001					
Markings	CE / CCA / GOST					
Safety	EN 50091-1-1: 1996; IEC 60950					
EMC	EN 50091-2: 1995					

Powerware at your service:

www.emea.powerware.com

EUROPE/MIDDLE EAST/ AFRICA LOCATIONS

DENMARK

Østmarken 9
DK-2860 Søborg
Tel. +45-3686 7910
Fax +45-3686 7921

FINLAND

Koskelontie 13
FIN-02920 Espoo
Tel. +358-9-452 661
Fax +358-9-452 665 68

FRANCE

ZAC des Delâches
BP 77
GOMETZ-LE-CHATEL
F-91940 Les Ulis
Tel. +33-1-60 12 74 00
Fax +33-1-60 12 74 01

GERMANY

Karl-Bold-Strasse 40
D-77855 Achern
Tel. +49-7841-6660
Fax +49-7841-5000

Am Weichselgarten 30 a
D-91058 Erlangen
Tel. +49-9131-77 70 240
Fax +49-9131-77 70 222

ITALY

Via Pellizza da Volpedo, 53
I-20092 Cinisello Balsamo
Milano
Tel. +39-02-66 04 05 40
Fax +39-02-66 04 06 50

NORWAY

Konowsgate 5
N-0192 Oslo
Tel. +47-23-03 65 50
Fax +47-23-03 65 55

POLAND

ul. Chrościckiego 93/105
02-414 Warsaw
Tel. +48-22-331 85 24 do 29
Fax +48-22-331 85 16

SWEDEN

Sågvägen 2
PO Box 543
S-184 25 Åkersberga
Tel. +46-8-598 940 00
Fax +46-8-598 940 40

UNITED KINGDOM

221 Dover Road
Slough SL1 4RS
Berkshire
Tel. +44-1753-608 700
Fax +44-1753-608 995

WORLDWIDE LOCATIONS

WORLD HEADQUARTERS

8609 Six Forks Road
Raleigh, NC 27615
Tel. +1-919-872 3020
Fax +1-919-870 3450

LATIN AMERICA

ARGENTINA

Belgrano 768
5th PISO
Buenos Aires 1092
Tel. +54-11-4343 6323
Fax +54-11-4334 0104

BRAZIL

Av. Ermano Marchetti,
1435 – Água Branca
05038-001 Sao Paulo
Tel. +55-11-3616 8500
Fax +55-11-3616 8558

ASIA PACIFIC

AUSTRALIA

119-127 Wicks Road
North Ryde
Sydney 2113 NSW
Tel. +61-2-9878 5000
Fax +61-2-9887 2186

CHINA

Room 2718, 27/F, South
Tower, Kerry Centre
No 1 Guanfhua Lu
Chaoyang District
Beijing 100020
Tel. +86-10-8529 9889
ext 129
Fax +86-10-8529 9879

HONG KONG

Room 1811, 18/F, Kodak
House II
38-39 Healthy Street East
North Point
Tel. +852-2745 6682
Fax +852-2745 6177

INDIA

4, Community Centre
Panchsheel Park
New Delhi 110017
Tel. +91-11-2649 941418
Fax +91-11-2649 9419

JAPAN

1-11-15 Higashi-Gotanda
Shinagawa
Tokyo 141-0022
Tel. +81-3-3447 5251
Fax +81-3-3447 5252

SINGAPORE

15 Changi Business Park,
Central 1
Singapore 486057
Tel. +65-6829 8380
Fax +65-6829 8302

NEW ZEALAND

14 The Boulevard
Sunnyhills-Pakuranga
Auckland 1706
Tel. +64-9-576 6842
Fax +64-9-576 6843

USA

2727 Kurtz Street
San Diego, CA 92110
Tel. +1-619-291 4211
Fax +1-619-291 2973