



ИБП Eaton Powerware 9390-80-N-4x0 - Встроенный батарейный кабинет Powerware 9390 (модели

Постоянная ссылка на страницу: <https://eaton-power.ru/catalog/eaton-9390/9390-80-n-4x0/>



**Powerware**

**Powerware® 9390  
Integrated Battery Cabinet (Models IBC-S and IBC-L)  
Installation Manual**

**IMPORTANT SAFETY INSTRUCTIONS  
SAVE THESE INSTRUCTIONS**

---

This manual contains important instructions that you should follow during installation and maintenance of the UPS and batteries. Please read all instructions before operating the equipment and save this manual for future reference.

---

**Consignes de sécurité**

**CONSIGNES DE SÉCURITÉ IMPORTANTES  
CONSERVER CES INSTRUCTIONS  
CE MANUEL CONTIENT DES CONSIGNES DE SÉCURITÉ IMPORTANTES**

Powerware is a registered trademark of Eaton Electrical Inc.

©Copyright 2004–2006 Eaton Corporation, Raleigh, NC, USA. All rights reserved. No part of this document may be reproduced in any way without the express written approval of Eaton Corporation.

# Table of Contents

<b>1</b>	<b>Introduction</b>	<b>1-1</b>
1.1	Battery Cabinet Configurations	1-2
1.2	UPS Systems Using Powerware 9390 Battery Cabinets	1-2
1.3	Using This Manual	1-3
1.4	Conventions Used in This Manual	1-3
1.5	Safety Warnings	1-4
1.6	For More Information	1-5
1.7	Getting Help	1-6
<b>2</b>	<b>Battery Cabinet Installation Plan and Unpacking</b>	<b>2-1</b>
2.1	Installation Sequence	2-1
2.2	Creating an Installation Plan	2-1
2.3	Preparing the Site	2-1
2.3.1	Environment Considerations	2-2
2.3.2	Preparing for Wiring the Battery System	2-2
2.4	Inspecting and Unpacking the Battery Cabinet	2-3
<b>3</b>	<b>Installing Battery Cabinets</b>	<b>3-1</b>
3.1	Preliminary Installation Information	3-1
3.2	Unloading the Battery Cabinet from the Pallet	3-2
3.3	Model IBC-S Battery Cabinet Installation	3-4
3.3.1	Line-up-and-Match IBC-S Installation	3-4
3.3.2	Line-up-and-Match IBC-S Electrical Connections	3-8
3.3.3	Standalone IBC-S Installation	3-10
3.3.4	Standalone IBC-S Electrical Connections	3-12
3.4	Model IBC-L Battery Cabinet Installation	3-13
3.4.1	Line-up-and-Match IBC-L Installation	3-14
3.4.2	Line-up-and-Match IBC-L Electrical Connections	3-18
3.4.3	Standalone IBC-L Installation	3-20
3.4.4	Standalone Battery Cabinet Electrical Connections	3-22
3.5	Completing the Installation Checklist	3-24
	<b>Appendix A – Installation Information</b>	<b>A-1</b>
	<b>Warranty</b>	<b>W-1</b>

**This page intentionally left blank.**

## List of Figures

Figure 1-1. Powerware 9390 Model IBC-S Battery Cabinet .....	1-1
Figure 1-2. Powerware 9390 Model IBC-L Battery Cabinet .....	1-2
Figure 2-1. Powerware 9390 Battery Cabinet as Shipped on Pallet (Model IBC-L shown) .....	2-3
Figure 3-1. Removing Shipping Supports .....	3-2
Figure 3-2. UPS with Line-up-and-Match IBC-S .....	3-4
Figure 3-3. UPS to IBC-S Joining Brackets .....	3-5
Figure 3-4. IBC-S Bottom Joining Brackets and Ground Wire .....	3-6
Figure 3-5. IBC-S Hanger Brackets .....	3-7
Figure 3-6. IBC-S Battery String Connection .....	3-9
Figure 3-7. UPS with Standalone IBC-S .....	3-10
Figure 3-8. UPS with Line-up-and-Match IBC-L .....	3-14
Figure 3-9. UPS to IBC-L Joining Brackets .....	3-15
Figure 3-10. IBC-L Bottom Joining Brackets and Ground Wire .....	3-16
Figure 3-11. IBC-L Battery Cabinet Hanger Brackets .....	3-17
Figure 3-12. IBC-L Battery String Connection .....	3-19
Figure 3-13. UPS with Standalone IBC-L .....	3-20

**This page intentionally left blank.**

## Chapter 1 | Introduction

During brownouts, blackouts, and other power interruptions, battery cabinets provide emergency DC power to the UPS to safeguard operation of the critical load.

The Integrated Battery Cabinet (IBC) systems are housed in single free-standing cabinets. Two models are available: Model IBC-S (small cabinet) and Model IBC-L (large cabinet). Each model features three battery voltage ranges to meet application run time needs. Up to four cabinets may be daisy-chained together to further extend battery run times. The cabinets match the UPS cabinet in style and color, and can be installed in line-up-and-match or *stand-alone* configurations. Figure 1-1 depicts the Powerware® 9390 Model IBC-S and Figure 1-2 depicts the Powerware 9390 Model IBC-L.

Mechanical lugs, located at the front of the cabinet, reduce installation time, and removable battery trays with quick disconnects between trays reduce battery maintenance time. A DC-rated circuit breaker within each cabinet provides protection and servicing isolation.

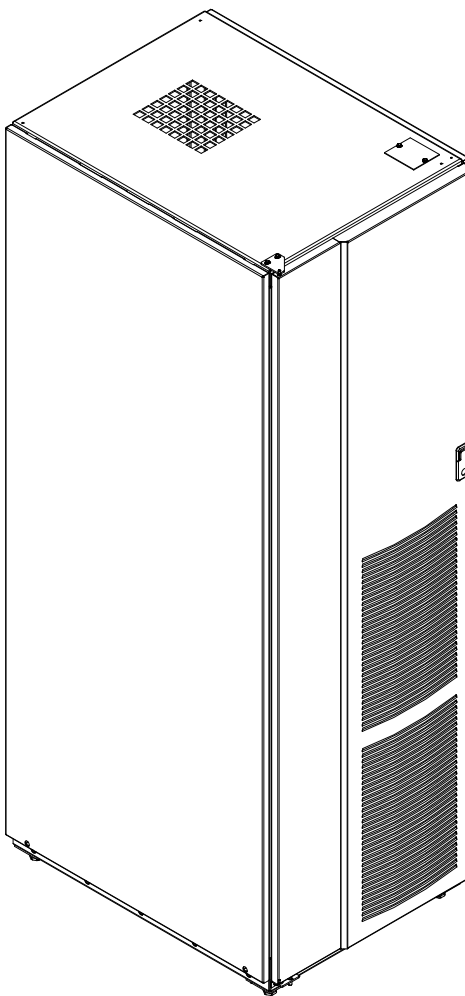

**Figure 1-1. Powerware 9390 Model IBC-S Battery Cabinet**



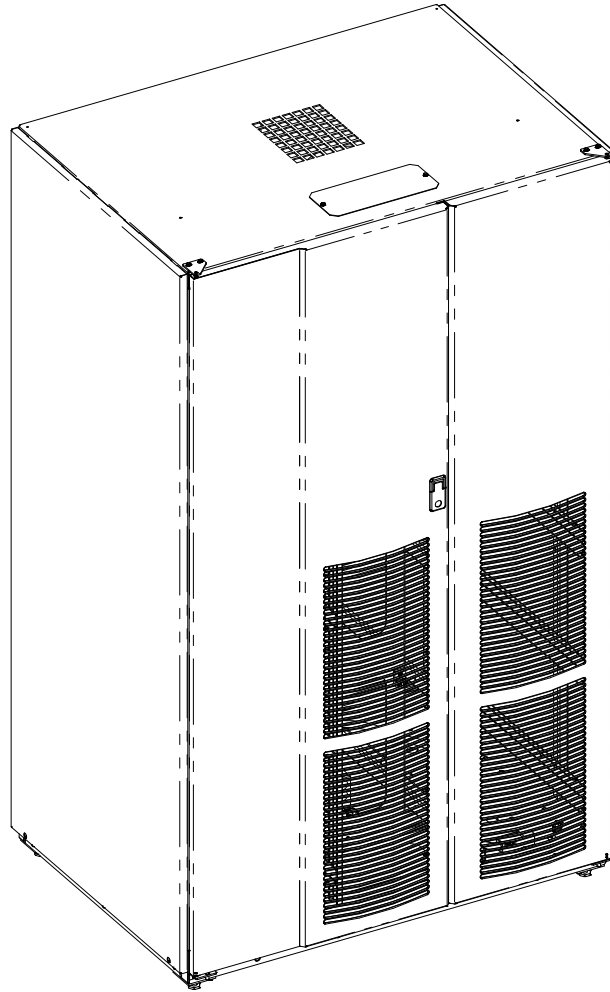

**Figure 1-2. Powerware 9390 Model IBC-L Battery Cabinet**

## 1.1 Battery Cabinet Configurations

Four basic battery cabinet configurations are possible:

- ▶ The UPS and one or more Model IBC-S units in a line-up-and-match configuration.
- ▶ The UPS and one or more Model IBC-S units in a standalone configuration.
- ▶ The UPS and one or more Model IBC-L units in a line-up-and-match configuration.
- ▶ The UPS and one or more Model IBC-L units in a standalone configuration.

## 1.2 UPS Systems Using Powerware 9390 Battery Cabinets

- ▶ Powerware 9390 40–80 kVA UPS (Model IBC-S and Model IBC-L)
- ▶ Powerware 9390 120–160 kVA UPS (Model IBC-L only)

## 1.3 Using This Manual

This manual describes how to install the Powerware 9390 battery cabinet. Read and understand the procedures described in this manual to ensure trouble-free installation.

The information in this manual is divided into the chapters listed. The type of battery cabinet installation dictates which parts of this manual should be read.

- ▶ **Chapter 1, “Introduction”** – provides a brief description of the battery system, a description of the content of each chapter, text conventions used in the manual, safety warnings, and reference information.
- ▶ **Chapter 2, “Battery Cabinet Installation Plan and Unpacking”** – explains how to prepare the site for the installation of the battery cabinet. It discusses equipment environmental requirements, inspecting, and unpacking cabinets.
- ▶ **Chapter 3, “Installing the Battery Cabinets”** – describes how to locate, install, and wire the battery cabinet.
- ▶ **Appendix A, “Installation Information”** – contains important information on wiring requirements and recommendations, and important diagrams of the cabinet's mechanical details and electrical access.
- ▶ **Warranty** – provides the Powerware warranty for this product.

Read through each procedure before beginning the procedure. Perform only those procedures that apply to the battery system being installed.

## 1.4 Conventions Used in This Manual

This manual uses these type conventions:

- ▶ **Bold type** highlights important concepts in discussions, key terms in procedures, and menu options.
- ▶ *Italic type* highlights notes and new terms where they are defined.
- ▶ `Screen type` represents information that appears on the screen.

Icon	Description
	Information notes call attention to important features or instructions.

In this manual, the term *UPS* refers only to the UPS cabinet and its internal elements. The term *UPS system* refers to the entire power protection system – the UPS cabinet, battery cabinet, and options or accessories installed.

The term *line-up-and-match* refers to battery cabinets that are physically attached to the UPS, share internal wiring, and use the battery cabinet breaker as the battery isolation device. The term *standalonet* refers to battery cabinets that are not physically attached to the UPS, are wired with external contractor-supplied wiring, and use a single overcurrent protection and disconnect device located near the batteries.

## 1.5 Safety Warnings

### IMPORTANT SAFETY INSTRUCTIONS SAVE THESE INSTRUCTIONS

---

This manual contains important instructions that should be followed during installation and maintenance of the batteries. Please read all instructions before operating the equipment and save this manual for future reference.

The battery cabinet is designed for industrial or computer room applications and should be handled with appropriate care.

---

#### DANGER



This battery cabinet contains **LETHAL VOLTAGES**. All repairs and service should be performed by **AUTHORIZED SERVICE PERSONNEL ONLY**. There are **NO USER SERVICEABLE PARTS** inside the UPS.

---

#### WARNING



- ▶ This battery cabinet contains its own energy source. The internal wiring and output terminals may carry live voltage even when the UPS is not connected to an AC source.
  - ▶ Never dispose of batteries in a fire. Batteries may explode when exposed to flame.
  - ▶ To reduce the risk of fire or electric shock, install the battery cabinet in a temperature and humidity controlled, indoor environment, free of conductive contaminants. Ambient temperature must not exceed 40°C (104°F). Do not operate near water or excessive humidity (95% max). The system is not intended for outdoor use.
  - ▶ Ensure all power is disconnected before performing installation or service.
  - ▶ Do not open or mutilate the battery or batteries. Released electrolyte is harmful to the skin and eyes, and may be toxic.
  - ▶ A battery can cause electrical shock, burn from high short-circuit current, or fire. Observe proper precautions.
-



## CAUTION

- ▶ Batteries can present a risk of electrical shock or burn from high short-circuit current. Observe proper precautions. Servicing should be performed by qualified service personnel knowledgeable of batteries and required precautions. Keep unauthorized personnel away from batteries.
  - ▶ Proper disposal of batteries is required. Refer to local codes for disposal requirements.
  - ▶ Keep the battery cabinet doors closed to ensure proper cooling airflow and to protect personnel from dangerous voltages inside the unit.
  - ▶ Do not install the battery cabinet close to gas or electric heat sources.
  - ▶ The operating environment should be maintained within the parameters stated in this manual.
  - ▶ Keep surroundings uncluttered, clean, and free from excess moisture.
  - ▶ Observe all DANGER, CAUTION, and WARNING notices affixed to the inside and outside of the equipment.
- 

## 1.6 For More Information

Refer to the ***Powerware 9390 UPS (40–80 kVA) Installation and Operation Manual*** or the ***Powerware 9390 UPS (120–160 kVA) Installation and Operation Manual*** for the following additional information:

- ▶ UPS cabinet, optional components, and accessory installation instructions, including site preparation, planning for installation, and wiring and safety information. Detailed illustrations of cabinets and optional accessories with dimensional and connection point drawings are provided.
- ▶ UPS operation, including UPS cabinet controls, functions of the UPS, standard features and optional accessories, procedures for starting and stopping the UPS, and information about maintenance and responding to system events.
- ▶ Communication capabilities of the UPS system.

Visit [www.powerware.com](http://www.powerware.com) or contact an Eaton Customer Service Representative for information on how to obtain copies of these manuals.

## 1.7 Getting Help

If help is needed with any of the following:

- ▶ Scheduling initial startup
- ▶ Regional locations and telephone numbers
- ▶ A question about any of the information in this manual
- ▶ A question this manual does not answer

Please call the Eaton Help Desk for Powerware products at:

In the United States **1-800-843-9433 or 1-919-870-3028**

In Canada **1-800-461-9166**

All other countries **Call your service representative**

## Chapter 2 | Battery Cabinet Installation Plan and Unpacking

### 2.1 Installation Sequence

Use the following basic sequence of steps to install the battery cabinet:

1. Create an installation plan for the battery cabinet (Chapter 2).
2. Prepare your site for the battery cabinet (Chapter 2).
3. Inspect and unpack the battery cabinet (Chapter 2).
4. Unload and install the battery cabinet, and wire the system (Chapter 3).
5. Complete the Installation Checklist (Chapter 3).
6. Have authorized service personnel perform preliminary operational checks and startup.



---

**NOTE** *Startup and operational checks must be performed by an authorized Powerware Customer Service Engineer, or the warranty terms, as specified on page W-1, will be void. This service is offered as part of the sales contract for the UPS. Contact service in advance (usually a two week notice is required) to reserve a preferred startup date.*

---

### 2.2 Creating an Installation Plan

Before installing the battery cabinet, read and understand how this manual applies to the system being installed. Use the procedures and illustrations in the following chapters to create a logical plan for installing the system.

### 2.3 Preparing the Site

For the battery system to operate at peak efficiency, the installation site should meet the environmental parameters outlined in this manual. If the battery system is to be operated at an altitude higher than 1500m (5000 ft), contact an Eaton Customer Service Representative for important information about high altitude operation. The operating environment must meet the weight, clearance, environmental requirements specified in Drawing 164201536-2 on page A-4 and size requirements specified on Drawing 164201536-9 starting on page A-19.

The Powerware 9390 Integrated Battery Cabinets use natural convection cooling to regulate internal component temperature. Air inlets are in the front of the cabinet and outlets are in the top. Clearance must be allowed in front of and above each cabinet for proper air circulation. See Drawing 164201536-2 on page A-4 for clearances.

### 2.3.1 Environment Considerations

The life of the battery system is adversely affected if the installation does not meet the following guidelines:

- ▶ The system must be installed on a level floor suitable for computer or electronic equipment.
- ▶ The system must be installed in a temperature and humidity controlled indoor area free of conductive contaminants.
- ▶ The Environmental Monitoring Probe (EMP), for remote monitoring of battery environmental conditions, must be installed and set up by an authorized Powerware Customer Service Engineer, or the extended battery warranty terms specified on page W-1 will be void.

Failure to follow guidelines may void your warranty.

### 2.3.2 Preparing for Wiring the Battery System

Power and control wiring for integral (line-up-and-match) battery cabinets are supplied with the cabinets.

Wiring requirements for battery cabinets installed separate from the UPS cabinet, including the minimum AWG size of external wiring, can be found on Drawing 164201536-5, Table D, starting on page A-10. The power wiring connections for this equipment are rated at 90°C. If wire is run in an ambient temperature greater than 30°C, higher temperature wire and/or larger size wire may be necessary. Battery control wiring requirements can be found on Drawing 164201536-8, starting on page A-17 and should be connected at the battery interface terminal block located inside the battery cabinet.

## 2.4 Inspecting and Unpacking the Battery Cabinet

The next step is inspecting and unpacking the battery cabinet. The cabinet is shipped bolted to a pallet consisting of four angle metal supports secured to two four-inch by six-inch wood supports, as shown in Figure 2-1, and protected with outer protective packaging material.

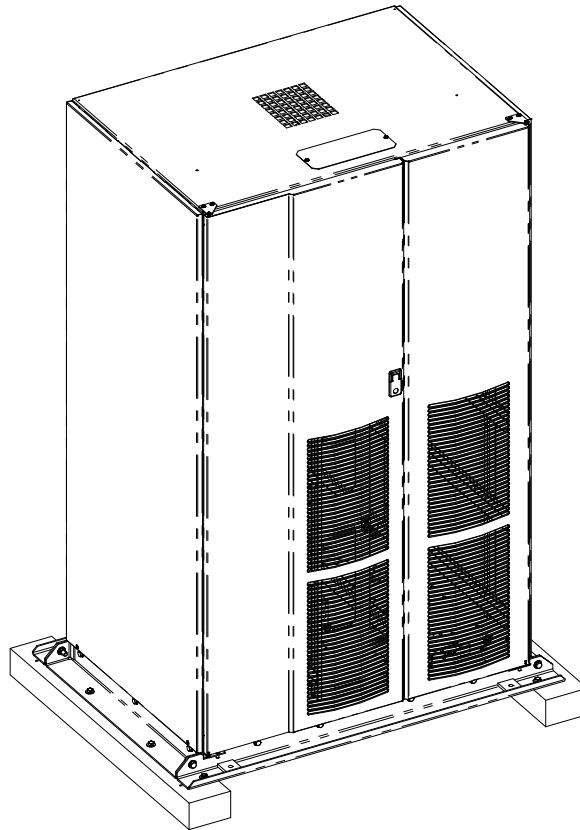

**Figure 2-1. Powerware 9390 Battery Cabinet as Shipped on Pallet (Model IBC-L shown)**



### CAUTION



The battery cabinet is extremely heavy (see Table A on page A-4). If unpacking instructions are not closely followed, the cabinet may tip and cause serious injury.

1. Carefully inspect the outer packaging for evidence of damage during transit.

### CAUTION



Do not install a damaged cabinet. Report any damage to the carrier and contact an Eaton Customer Service Representative immediately.

2. Use a forklift or pallet jack to move the packaged cabinet to the installation site, or as close as possible, before unpacking. Insert the forklift or pallet jack's forks between the pallet supports on the bottom of the unit.



**NOTE** *Verify that the forklift or pallet jack is rated to handle the weight of the cabinet (see Table A on page A-4 for cabinet weight).*

### CAUTION



Do not tilt the battery cabinet more than 10° from vertical or cabinet may tip over.

3. Set the pallet on a firm, level surface, allowing a minimum clearance of 3m (10 ft) on each side for removing the cabinet from the pallet.
4. Remove the protective covering from the cabinet.
5. Remove the packing materials, and discard or recycle them in a responsible manner.
6. After removing the protective covering, inspect the contents for any evidence of physical damage, and compare each item with the Bill of Lading. If damage has occurred or shortages are evident, contact an Eaton Customer Service Representative immediately to determine the extent of the damage and its impact upon further installation.



**NOTE** *While waiting for installation, protect the unpacked cabinet from moisture, dust, and other harmful contaminants. Failure to store and protect the battery cabinet properly may void your warranty.*

## Chapter 3 | Installing Battery Cabinets

### 3.1 Preliminary Installation Information



#### **WARNING**

The installation of battery cabinets should be performed or supervised by personnel knowledgeable of batteries and their associated precautions. Keep unauthorized personnel away from battery cabinets.

Observe these precautions when working on or around battery cabinets:

- ▶ Remove watches, rings, or other metal objects.
- ▶ Use tools with insulated handles.
- ▶ Wear rubber gloves and boots.
- ▶ Do not lay tools or metal parts on top of batteries or battery cabinets.

Refer to the following while installing the battery system:

- ▶ See Appendix A for installation drawings and additional installation notes.
- ▶ Refer to the appropriate Powerware 9390 UPS Installation and Operation Manual, as referenced in paragraph 1.6, for UPS cabinet conduit and terminal locations, and terminal specifications.
- ▶ Dimensions in this manual are in millimeters and inches.
- ▶ Do not tilt the cabinets more than  $\pm 10^\circ$  during installation.
- ▶ The conduit landing plates are to be removed to add conduit landing holes as required. Plate material is 16 gauge steel (1.5 mm/0.06" thick).
- ▶ The cabinets must be installed on a level floor suitable for computer or electronic equipment.
- ▶ See Table A on page A-4 for equipment weight and point loading.
- ▶ Details about control wiring are provided in each procedure. Drawing 164201536-8 starting on page A-17 identifies the control wiring terminations.
- ▶ The Environmental Monitoring Probe, for remote monitoring of battery environmental conditions, must be installed and setup by an authorized Powerware Customer Service Engineer, or the extended battery warranty terms, as specified on page W-1, will be void.
- ▶ Once the battery cabinets are installed and wired, return to the appropriate Powerware 9390 UPS Installation and Operation Manual, as referenced in paragraph 1.6, to complete the UPS wiring.

## 3.2 Unloading the Battery Cabinet from the Pallet

The battery cabinet is bolted to a pallet consisting of four angle metal supports secured to two four-inch by six-inch wood supports.

1. Unfasten front door latch and swing doors open.
2. Remove doors. Remove the retaining screw located inside each door at the bottom hinge pivot point, then lift the door off. Save the retaining screws for reinstallation of the doors.
3. Locate the field kit (packed inside of the cabinet). Locate the four 1/2" jacking bolts and install them in the threaded holes in the front and rear supports. Place a floor protector underneath each jacking bolt, and screw the bolts down against them. The floor protectors protect the floor from being marred by the jacking bolts.

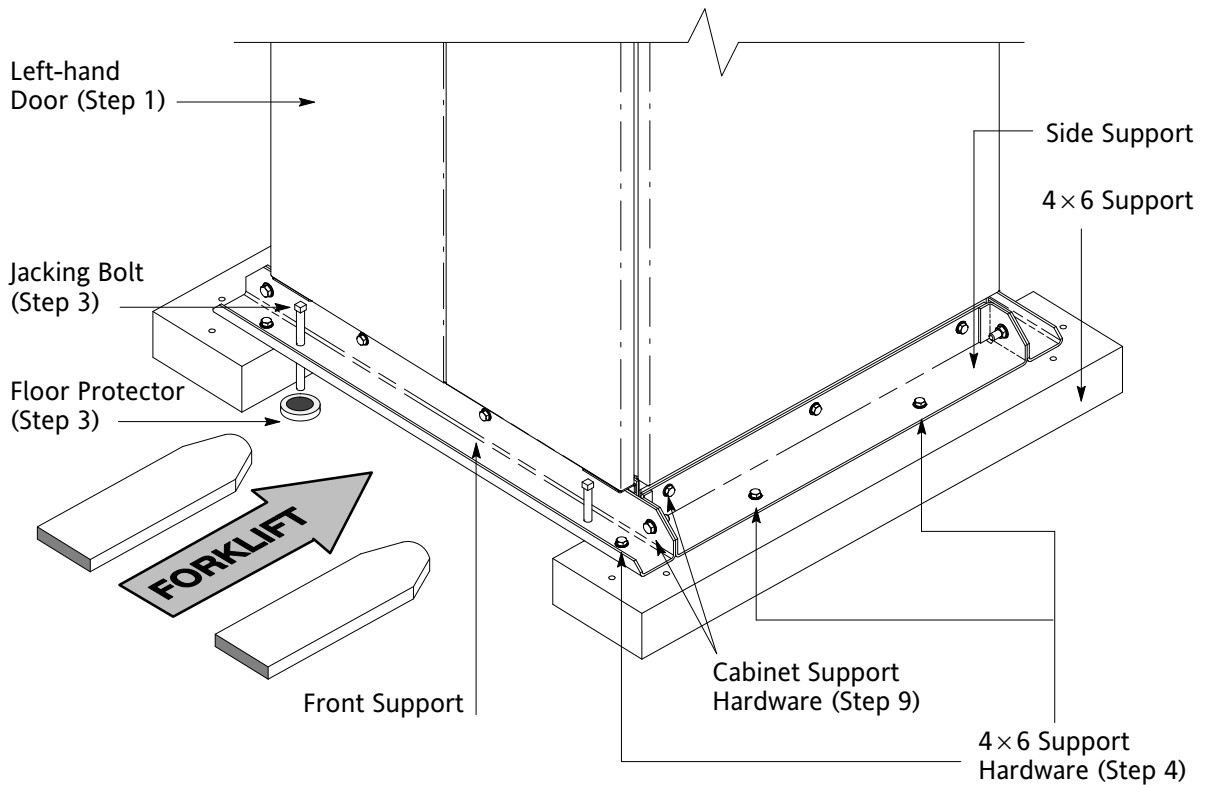

**Figure 3-1. Removing Shipping Supports**

4. Loosen, but do not remove, the hardware holding the 4×6 supports to the front and rear supports.



### WARNING

SERIOUS INJURY MAY OCCUR. Battery cabinets are extremely heavy. If unloading instructions are not closely followed, cabinet may tip.

5. Turn each jacking bolt consecutively, two full turns, until the 4 × 6 supports clear the floor by approximately 3 mm (1/8").

### WARNING



RISK OF INSTABILITY. Turning the jacking bolts unevenly may cause the cabinet to become unbalanced. To prevent tipping the cabinet, raise and lower the jacking bolts evenly.

### CAUTION



CABINET MAY TIP. The battery cabinet should only be raised approximately 3 mm (1/8") above the floor (just enough to allow removal of the 4 × 6 supports).

6. After the 4 × 6 supports clear the floor, remove the hardware loosened in Step 4. Pull the 4 × 6 supports out from under the battery cabinet. Please discard or recycle them in a responsible manner.

### CAUTION



CABINET MAY FALL. Do not loosen the hardware attaching the side or front supports to the cabinet base, or the front and side supports to each other, at this time. The cabinet must be lowered by the jacking bolts before the supports can be removed.

7. Carefully and evenly **lower the cabinet by turning each jacking bolt consecutively two full turns (maximum)** until the casters contact the floor, and the cabinet is no longer supported by the jacking bolts.
8. After the battery cabinet is resting on the floor, remove the jacking bolts and discard or recycle them in a responsible manner.
9. Remove the hardware holding the front, rear and side supports to the cabinet base. Discard or recycle the hardware and support brackets in a responsible manner.
10. The battery cabinet is now ready to be rolled to its final location.
11. Repeat Steps 2 through 10 for each cabinet you are preparing to install.

### 3.3 Model IBC-S Battery Cabinet Installation

The method used to install the battery cabinets depends on the type of installation being undertaken.

Each battery cabinet can be installed as a line-up-and-match or standalone system. The term *line-up-and-match* refers to battery cabinets that are physically attached to the UPS, share internal wiring, and use the battery cabinet breaker as the battery isolation device. The term *standalone* refers to battery cabinets that are not physically attached to the UPS, are wired with external contractor-supplied wiring, and use a single overcurrent protection and disconnect device located near the batteries.

- ▶ To install an line-up-and-match battery system, proceed to paragraph 3.3.1.
- ▶ To install a standalone battery system, proceed to paragraph 3.3.3.

#### 3.3.1 Line-up-and-Match IBC-S Installation

Use this procedure to join battery cabinets to the Powerware 9390 UPS cabinet (see Figure 3-2). The battery cabinet may be located to either the left or right of the UPS cabinet. The recommended location is to the left of the UPS cabinet. This procedure assumes the battery cabinet is located to the left of the UPS cabinet.

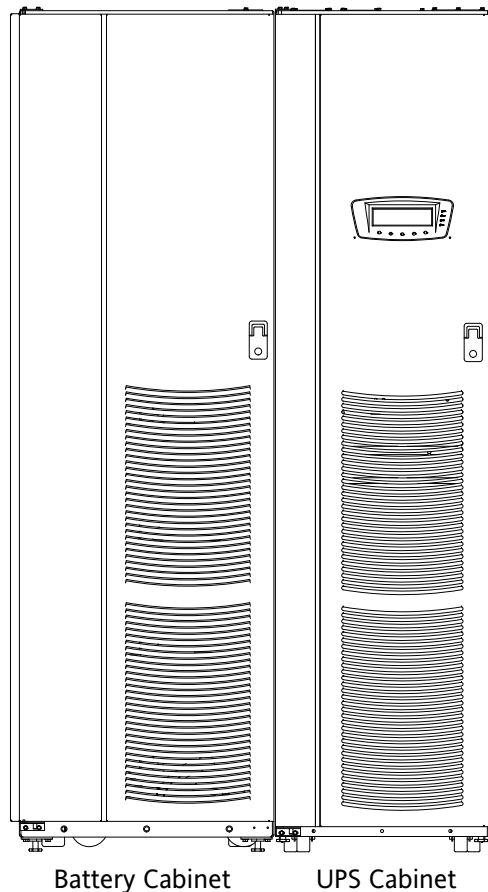

**Figure 3-2. UPS with Line-up-and-Match IBC-S**

1. Verify that the UPS is properly installed and secured. Refer to the appropriate Powerware 9390 UPS Installation and Operation Manual, as referenced in paragraph 1.6, for installation instructions.
2. Roll the battery cabinet to an area near the left-hand side of the UPS, as shown in Figure 3-3.
3. Remove the field kit. The field kit is attached with cable ties to the frame inside the door. Retain the field kit for later use.



**NOTE** When a line-up-and-match UPS system is ordered together with battery cabinets, the first battery cabinet is supplied with two cosmetic covers. The UPS cabinet, additional battery cabinets, and other ancillary cabinets are supplied without cosmetic covers.

**NOTE** When cabinets are properly aligned, all cabinet doors are flush.

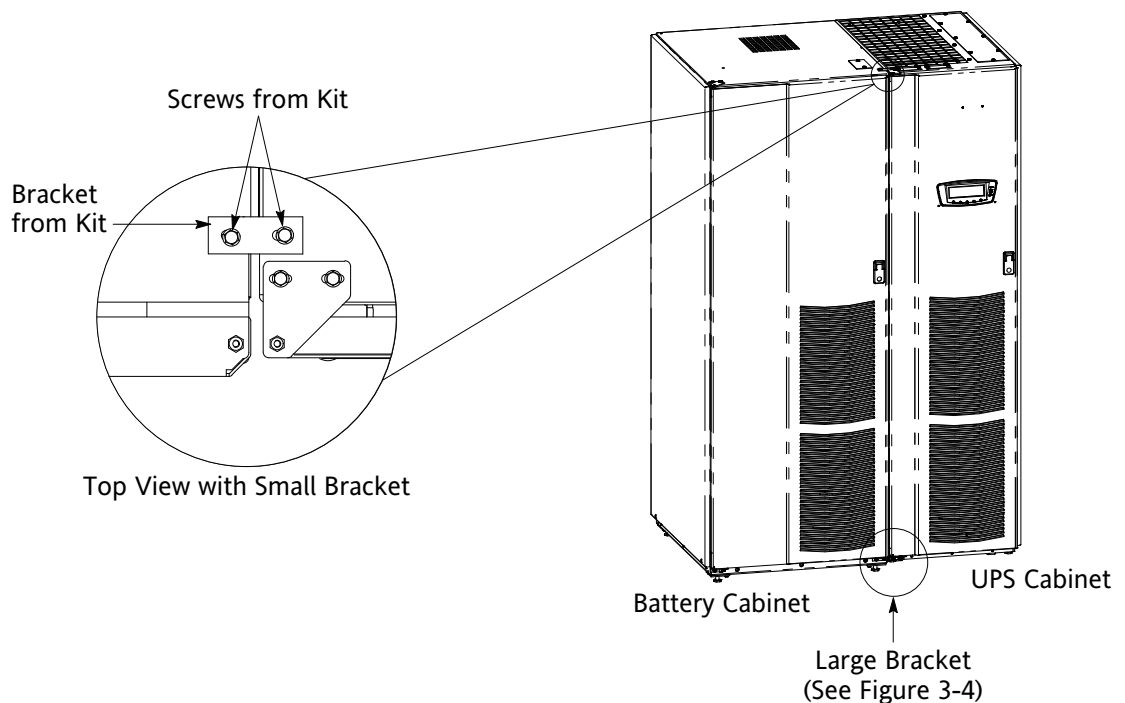

**Figure 3-3. UPS to IBC-S Joining Brackets**

4. If necessary, remove the cosmetic cover and hanger brackets from the left-hand side of the UPS. Save cover, screws, and brackets for later use.
5. If necessary, remove the cosmetic cover and hanger brackets from the right-hand side of the battery cabinet. Save cover, screws, and brackets for later use.
6. Remove the knockout plug on the bottom left side of the UPS cabinet inside panel. Refer to Appendix A of the appropriate Powerware 9390 UPS Installation and Operation Manual, as referenced in paragraph 1.6, for the location of the knockout plug.

7. Install nylon grommet from field kit around hole left after removal of knockout plug.
8. Push the battery cabinet toward the UPS cabinet until the doors are flush with each other.
9. Secure the battery cabinet position by lowering the leveling feet until cabinet is not resting on the casters. Ensure the cabinet is level and matches the height of the installed UPS cabinet.



**NOTE** Two cabinet joining brackets are provided in the field kit for securing each cabinet at the top and bottom. A small flat bracket joins the top of the cabinets, and a larger angle bracket joins the cabinets at the bottom. The small flat bracket is attached to the cabinet tops first.

10. Locate the small flat bracket from the field kit. Align the holes in the small flat bracket over the two holes in the top front of the cabinets. Secure the bracket to the cabinets with screws from the field kit (see Figure 3-3).
11. Locate the large angle bracket from the field kit. Place one end of the bracket over the bolt on the bottom side of the lower left-hand hinge on the UPS cabinet, and secure the bracket to the hinge with hardware from the field kit (see Figure 3-4).

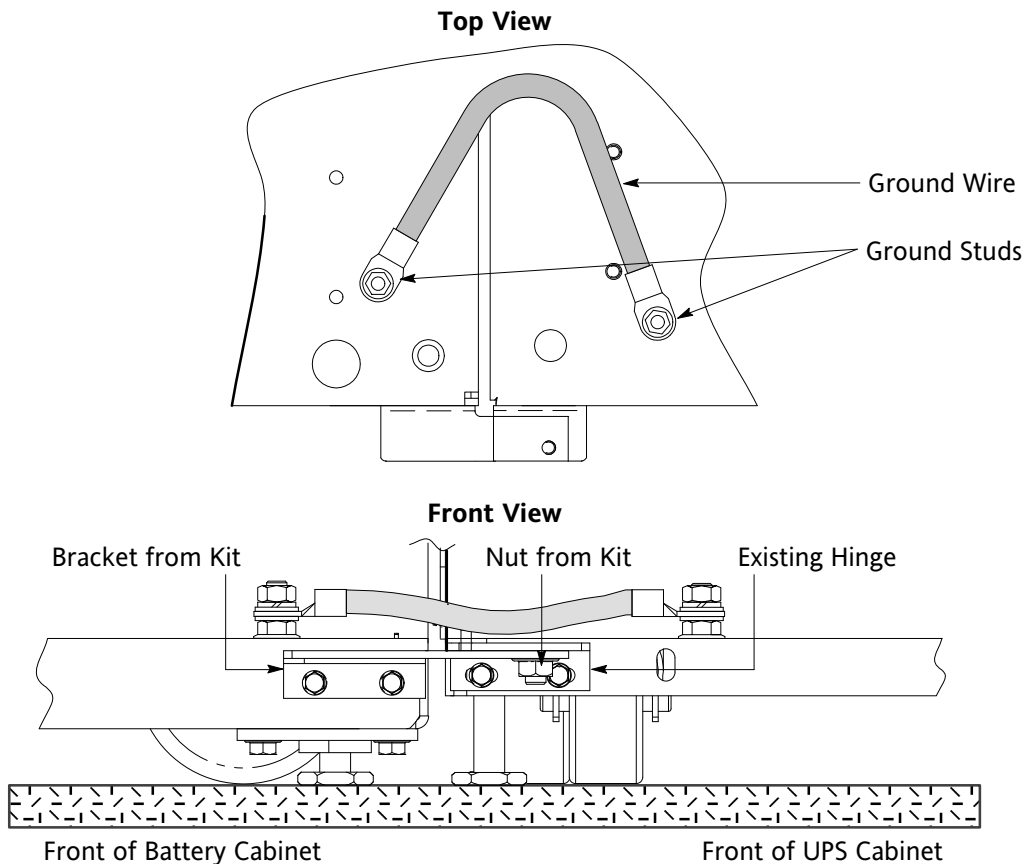

**Figure 3-4. IBC-S Bottom Joining Brackets and Ground Wire**

12. Align the holes in the other end of the bracket with the holes in the bottom right-hand side of the battery cabinet (see Figure 3-4). Secure the bracket with hardware from the field kit.
13. Route the ground wire (from the field kit) from the ground stud in the battery cabinet, under the lower right-hand battery tray, through the access hole in the side panel of the UPS, and attach to the ground stud in the UPS cabinet (see Figure 3-4). Hardware is provided on each ground stud.
14. If installing additional battery cabinets, repeat Steps 2 through 13 to join each additional battery cabinet; otherwise, proceed to Step 15.
15. If not already installed, mount the hanger brackets to the top left side of the last battery cabinet using M4 screws (see Figure 3-5).
16. If not already installed, hang the side panel on the hanger brackets and align with the front and rear of the battery cabinet.
17. If not already secured, secure the side panel at the bottom using M4 hex-head screws previously removed.
18. Proceed to paragraph 3.3.2.

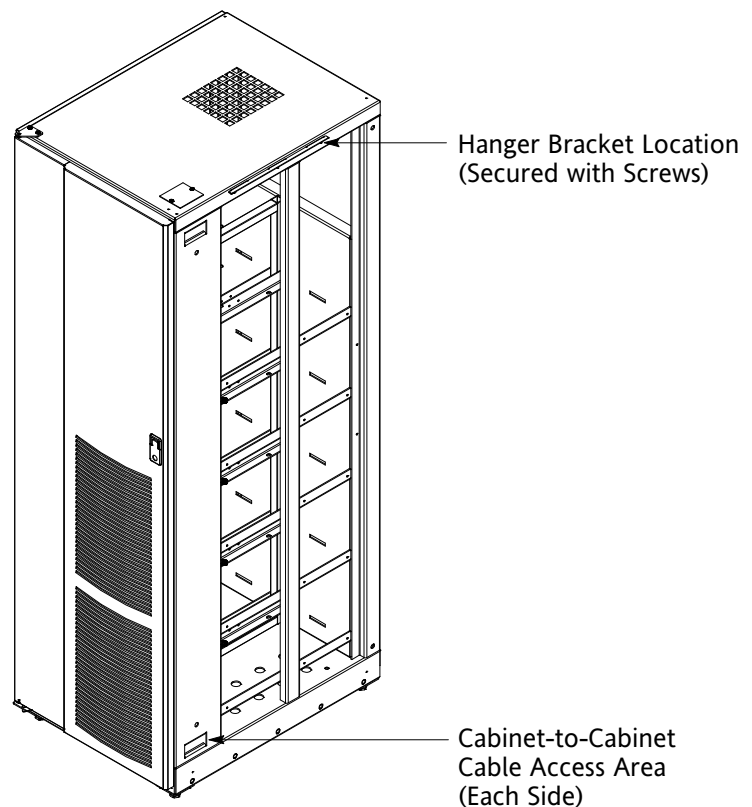

**Figure 3-5. IBC-S Hanger Brackets**



### 3.3.2 Line-up-and-Match IBC-S Electrical Connections

Use this procedure to wire an line-up-and-match battery cabinet to the Powerware 9390 UPS cabinet. All battery cabinets arrive at the site with each battery connection string electrically disconnected. If you are installing more than one battery cabinet, the battery cabinet adjacent to the UPS will be the only cabinet directly connected to the UPS.



#### DANGER

**LETHAL VOLTAGE** is present when performing the remaining steps in this section and subsequent sections.

1. Locate the battery cabinet-to-battery cabinet breaker sensing cable in the first battery cabinet. Route this connector into the cabinet to the immediate left and mate with the matching connector in that cabinet (see Drawing 164201536-8 on page A-17).
2. If installing multiple battery cabinets, proceed to Step 3; otherwise, proceed to Step 5.
3. On first and middle battery cabinet TB1 terminal boards, disconnect jumper from terminal 4 and connect to terminal 5. On last battery cabinet TB1 terminal board, verify jumper is connected between terminals 4 and 10. See Drawings 164201536-3 and 164201536-8.
4. Proceed to Step 6.
5. On battery cabinet TB1 terminal board, verify jumper is connected between terminals 4 and 10. See Drawings 164201536-3 and 164201536-8.
6. Locate the battery wiring harness in the first battery cabinet. Route this harness into the cabinet to the immediate left and connect the (+) lead to the (+) battery terminal and the (-) lead to the (-) battery terminal (see Drawing 164201536-7 starting on page A-14). Use pressure and bus bar terminations, as necessary, for connecting cables between the battery cabinets.
7. Repeat Steps 1 through 6 for each battery cabinet, and then proceed to Step 8.
8. Locate the UPS-to-battery cabinet breaker sensing cable inside the first battery cabinet. Mate the connector on this cable with the matching connector in the cabinet (see Drawing 164201536-8 on page A-17). Route the other end of this cable into the UPS cabinet and connect to terminal strip TB2. Refer to the appropriate Powerware 9390 UPS Installation and Operation Manual, as referenced in paragraph 1.6, for UPS cabinet terminal locations.

9. A UPS-to-battery wiring harness is supplied inside the first battery cabinet. Use pressure and bus bar terminations, as necessary, for connecting cables between the UPS and battery cabinet. Connect and route cables from positive (+) and negative (–) terminals in the the first battery cabinet into the UPS cabinet. Connect the (+) lead to terminal E4 (+) and the (–) to terminal E5 (–) in the UPS cabinet. Refer to the appropriate Powerware 9390 UPS Installation and Operation Manual, as referenced in paragraph 1.6, for UPS cabinet terminal locations.
10. Verify that all battery breakers are in the OFF position.
11. Connect the string of battery trays by mating the loose red connector from each tray to the fixed black connector mounted on the front edge of the tray above. Connect the top and bottom tray connectors to the mating cabinet connectors to complete the battery string connections (see Figure 3-6).
12. Repeat Step 10 for each battery cabinet, and then proceed to Step 13.
13. Replace the doors that were removed in paragraph 3.2.
14. Secure all battery cabinets by closing and latching the doors.
15. Once the battery cabinets are installed and wired, return to the appropriate Powerware 9390 UPS Installation and Operation Manual, as referenced in paragraph 1.6, to complete the UPS wiring.

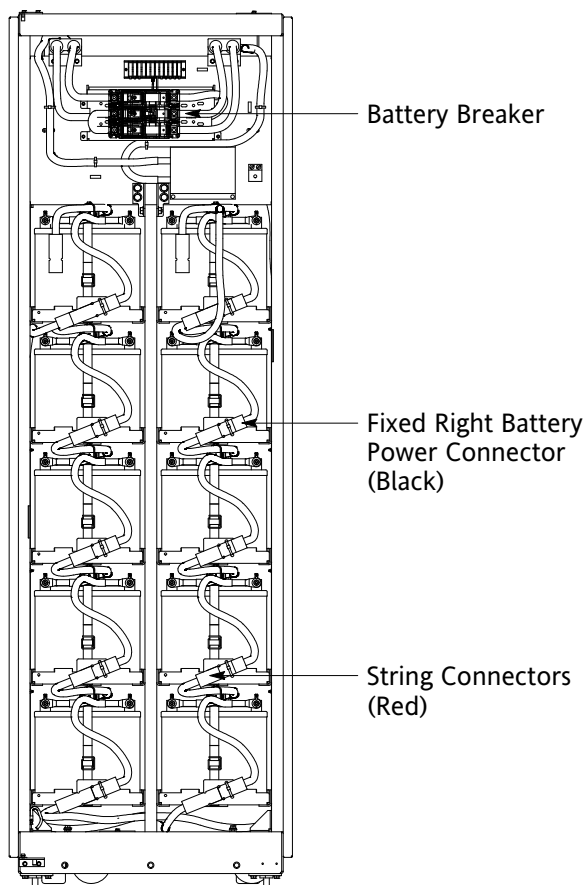

**Figure 3-6. IBC-S Battery String Connection**

### 3.3.3 Standalone IBC-S Installation

Use this procedure to install a standalone battery cabinet (see Figure 3-7).

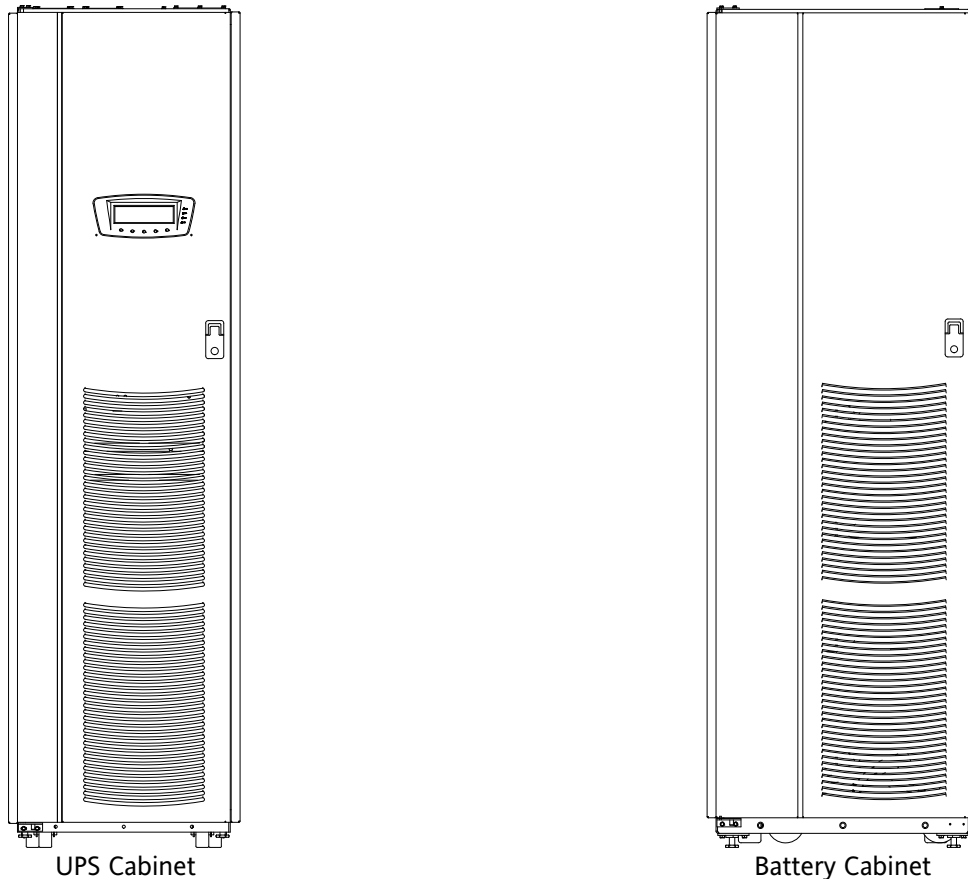

**Figure 3-7. UPS with Standalone IBC-S**

1. Verify that the UPS is properly installed and secured. Refer to the appropriate Powerware 9390 UPS Installation and Operation Manual, as referenced in paragraph 1.6, for installation instructions.
2. Roll the battery cabinet to the area where the battery cabinet is to be installed.
3. Secure the battery cabinet in position by lowering the leveling feet until cabinet is not resting on the casters and the cabinet is level.
4. Remove the field kit. The field kit is attached with cable ties to the frame inside the door. Retain the field kit for later use.
5. If installing more than one battery cabinet, proceed to Step 6; otherwise, proceed to paragraph 3.3.4.



**NOTE** *When a UPS system is ordered together with battery cabinets for standalone installation, the first battery cabinet is supplied with two cosmetic covers. Additional battery cabinets are supplied without cosmetic covers. Cosmetic covers must be ordered for the UPS cabinet and/or other ancillary cabinets.*

6. Remove the cosmetic cover and hanger brackets from the appropriate side or sides of the battery cabinets, depending on the position of the cabinets. Save covers, screws, and brackets for later use.
7. Roll the next battery cabinet to be joined to an area near the appropriate side of the first battery cabinet.
8. Push the battery cabinet to be joined towards the first battery cabinet until the doors are flush with each other.
9. Secure the battery cabinet position by lowering the leveling feet until cabinet is not resting on the casters. Ensure the cabinet is level and matches the height of the first installed battery cabinet.



---

**NOTE** *Two cabinet joining brackets are provided in the field kit for securing each cabinet at the top and bottom. A small flat bracket joins the top of the cabinets, and a larger angle bracket joins the cabinets at the bottom. The flat bracket is attached to the cabinet tops first.*

---

10. Locate the small flat bracket from the field kit. Align the holes in the flat bracket over the two holes in the top front of the cabinets. Secure the bracket to the cabinets with screws from the field kit (see Figure 3-3).
11. Locate the large angle bracket from the field kit. Place one end of the bracket over the bolt on the bottom side of the lower left-hand hinge on the adjacent battery cabinet, and secure the bracket to the hinge with hardware from the field kit (see Figure 3-4).
12. Align the holes in the other end of the bracket with the holes in the bottom right-hand side of the next battery cabinet (see Figure 3-4). Secure the bracket with hardware from the field kit.
13. Route the ground wire (from the field kit) from the ground stud in one battery cabinet, under the lower battery tray and through the cabinet-to-cabinet cable access area in the side of the cabinets, and attach to the ground stud in the other battery cabinet (see Figure 3-4 and Figure 3-5). Hardware is provided on each ground stud.
14. If installing additional battery cabinets, repeat Steps 6 through 13 to join each additional battery cabinet; otherwise, proceed to Step 15.
15. If not already installed, mount the hanger brackets to the top appropriate side of the last battery cabinet using M4 screws (see Figure 3-5).
16. If not already installed, hang the side panel on the hanger brackets and align with the front and rear of the battery cabinet.
17. If not already secured, secure the side panel at the bottom using M4 hex-head screws previously removed.
18. Proceed to paragraph 3.3.4.

### 3.3.4 Standalone IBC-S Electrical Connections

Use this procedure to wire a standalone battery cabinet to the Powerware 9390 UPS cabinet. All battery cabinets arrive at the site with each battery connection string electrically disconnected. If you are installing more than one battery cabinet, the first battery cabinet will be the only cabinet directly connected to the UPS.



#### DANGER

**LETHAL VOLTAGE** is present when performing the remaining steps in this section and subsequent sections.

1. Locate the battery breaker sensing cable in the right-hand battery cabinet. Route this connector into the cabinet to the immediate left and mate with the matching connector in that cabinet (see Drawing 164201536-8 on page A-17).
2. If installing multiple battery cabinets, proceed to Step 3; otherwise, proceed to Step 5.
3. On first and middle battery cabinet TB1 terminal boards, disconnect jumper from terminal 4 and connect to terminal 5. On last battery cabinet TB1 terminal board, verify jumper is connected between terminals 4 and 10. See Drawings 164201536-3 and 164201536-8.
4. Proceed to Step 6.
5. On battery cabinet TB1 terminal board, verify jumper is connected between terminals 4 and 10. See Drawings 164201536-3 and 164201536-8.
6. Locate the battery wiring harness in the first battery cabinet. Route this harness into the next cabinet and connect the (+) lead to the (+) battery terminal and the (-) lead to the (-) battery terminal (see Drawing 164201536-7 on page A-14). Use pressure and bus bar terminations, as necessary, for connecting cables between the battery cabinets.
7. Repeat Steps 1 through 6 for each battery cabinet, and then proceed to Step 8.
8. Refer to the following to connect the external wiring from the first battery cabinet to the UPS cabinet:
  - a. See Drawing 164201536-5 on page A-9 to size wire for connecting the battery cabinets to the remotely located UPS cabinet.
  - b. See Drawing 164201536-6 starting on page A-12 for battery cabinet top or bottom conduit landing locations.
  - c. See Drawing 164201536-7 on page A-14 for location of positive (+) and negative (-) terminals.
  - d. Refer to the appropriate Powerware 9390 UPS Installation and Operation Manual, as referenced in paragraph 1.6, for top or bottom conduit landing locations.

9. Locate the UPS-to-battery cabinet breaker sensing cable inside the first battery cabinet. Mate the connector on this cable with the matching connector in the cabinet (see Drawing 164201536-8 on page A-17). Route the other end of this cable through conduit (top or bottom entry) to UPS cabinet and connect to terminal strip TB2. Refer to the appropriate Powerware 9390 UPS Installation and Operation Manual, as referenced in paragraph 1.6, for UPS cabinet terminal locations.
10. Use pressure and bus bar terminations, as necessary, for connecting cables between the UPS and battery cabinet. Connect and route cables from positive (+) and negative (-) terminals in the first battery cabinet through conduit (top or bottom entry) to UPS cabinet terminals E4 and E5.
11. Verify that all battery breakers are in the OFF position.
12. Connect the string of battery trays by mating the loose red connector from each tray to the fixed black connector mounted on the front edge of the tray above. Connect the top and bottom tray connectors to the mating cabinet connectors to complete the battery string connections (see Figure 3-6).
13. Repeat Step 11 for each battery cabinet, and then proceed to Step 14.
14. Replace the doors that were removed in paragraph 3.2.
15. Secure all battery cabinets by closing and latching the doors.
16. Once the battery cabinets are installed and wired, return to the appropriate Powerware 9390 UPS Installation and Operation Manual, as referenced in paragraph 1.6, to complete the UPS wiring.

## 3.4 Model IBC-L Battery Cabinet Installation

The method used to install the battery cabinets depends on the type of installation being undertaken.

Each battery cabinet can be installed as a line-up-and-match or standalone system. The term *line-up-and-match* refers to battery cabinets that are physically attached to the UPS, share internal wiring, and use the battery cabinet breaker as the battery isolation device. The term *standalone* refers to battery cabinets that are not physically attached to the UPS, are wired with external contractor-supplied wiring, and use a single overcurrent protection and disconnect device located near the batteries.

- ▶ To install an line-up-and-match battery system, proceed to paragraph 3.4.1.
- ▶ To install a standalone battery system, proceed to paragraph 3.4.3.

### 3.4.1 Line-up-and-Match IBC-L Installation

Use this procedure to join battery cabinets to the Powerware 9390 UPS cabinet (see Figure 3-8). The battery cabinet may be located to either the left or right of the UPS cabinet. The recommended location is to the left of the UPS cabinet. This procedure assumes the battery cabinet is located to the left of the UPS cabinet.

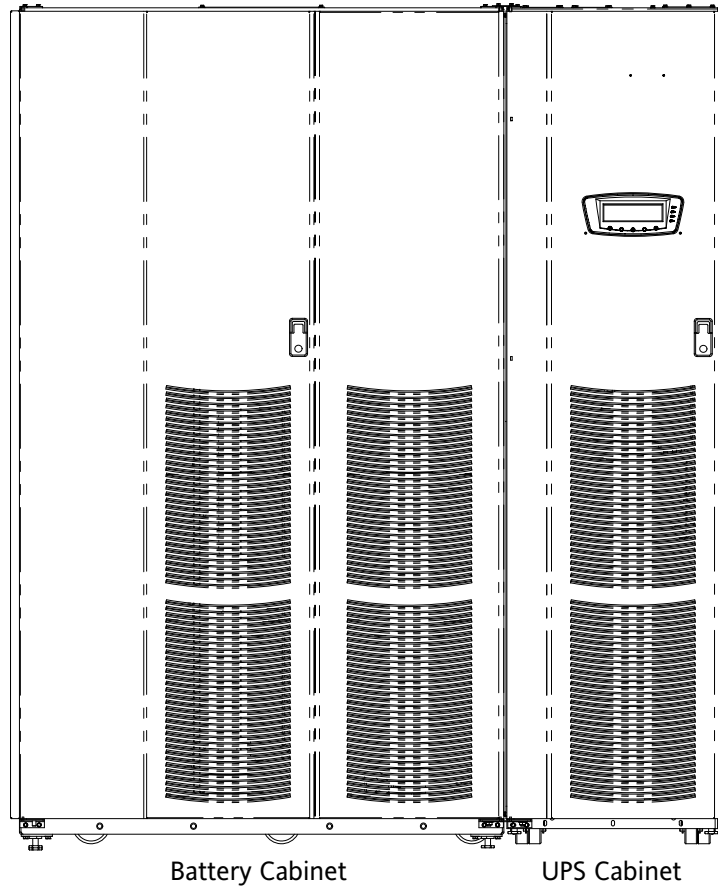

**Figure 3-8. UPS with Line-up-and-Match IBC-L**

1. Verify that the UPS is properly installed and secured. Refer to the appropriate Powerware 9390 UPS Installation and Operation Manual, as referenced in paragraph 1.6, for installation instructions.
2. Roll the battery cabinet to an area near the left-hand side of the UPS, as shown in Figure 3-9.
3. Remove the field kit. The field kit is attached with cable ties to the frame inside the door. Retain the field kit for later use.



**NOTE** *When a line-up-and-match UPS system is ordered together with battery cabinets, the first battery cabinet is supplied with two cosmetic covers. The UPS cabinet, additional battery cabinets, and other ancillary cabinets are supplied without cosmetic covers.*



**NOTE** When cabinets are properly aligned, all cabinet doors are flush.

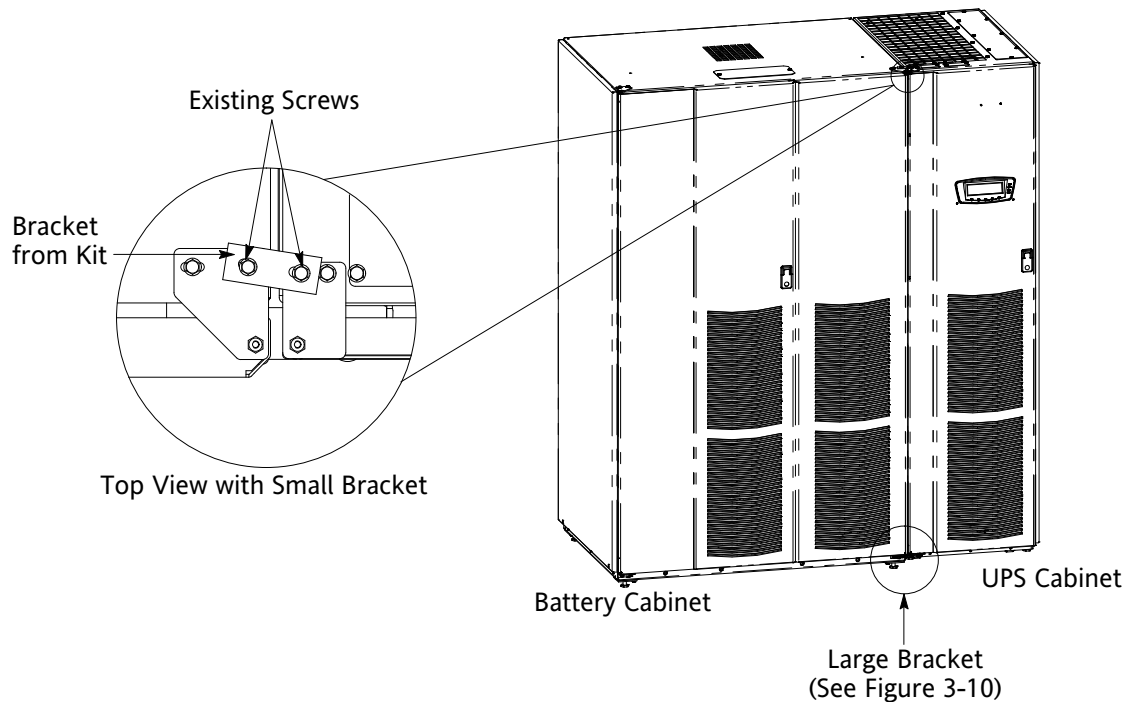

**Figure 3-9. UPS to IBC-L Joining Brackets**

4. If necessary, remove the cosmetic cover and hanger brackets from the left-hand side of the UPS. Save cover, screws, and brackets for later use.
5. If necessary, remove the cosmetic cover and hanger brackets from the right-hand side of the battery cabinet. Save cover, screws, and brackets for later use.
6. Remove the knockout plug on the bottom left side of the UPS cabinet inside panel. Refer to Appendix A of the appropriate Powerware 9390 UPS Installation and Operation Manual, as referenced in paragraph 1.6, for the location of the knockout plugs.
7. Install the nylon grommet from the field kit around hole left after removal of knockout plug.
8. Push the battery cabinet toward the UPS cabinet until the doors are flush with each other.
9. Secure the battery cabinet position by lowering the leveling feet until cabinet is not resting on the casters. Ensure the cabinet is level and matches the height of the installed UPS cabinet.





**NOTE** Two cabinet joining brackets are provided in the field kit for securing each cabinet at the top and bottom. A small flat bracket joins the top of the cabinets and a larger flat bracket joins the cabinets at the bottom. The small flat bracket is attached to the cabinet tops first.

10. Remove the left-hand screw from the top door hinge of the UPS cabinet and the right-hand screw from the top right door hinge of the battery cabinet.
11. Locate the small flat bracket from the field kit. Align the holes in the small flat bracket over the door hinge screw holes. Replace the screws in the hinges, securing the bracket to the cabinets (see Figure 3-9).
12. Locate the large flat bracket from the field kit. Place one end of the bracket over the bolt on the bottom side of the lower right-hand hinge on the battery cabinet and the other end over the bolt on the bottom side of the lower left-hand hinge on the UPS cabinet (see Figure 3-10).

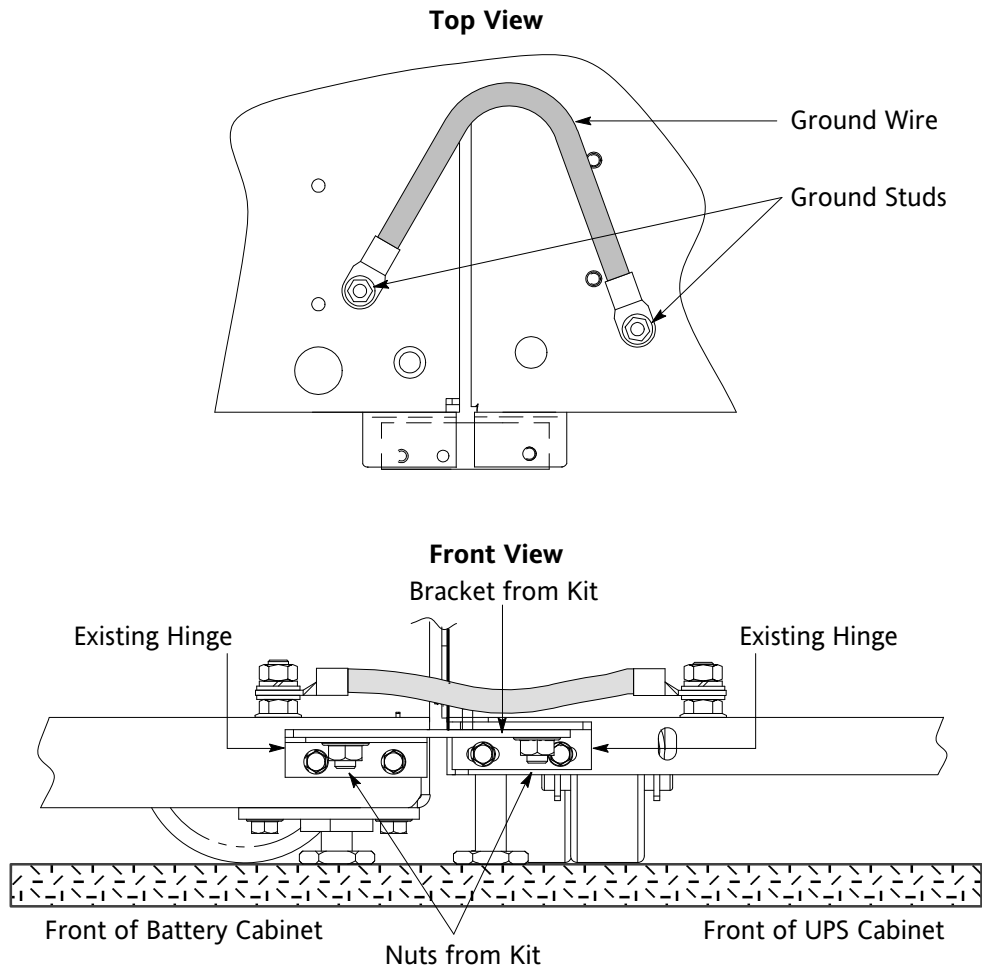

**Figure 3-10. IBC-L Bottom Joining Brackets and Ground Wire**

13. Secure the bracket to the hinges with hardware from the field kit.
14. Route the ground wire (from the field kit) from the ground stud in the battery cabinet, under the lower right-hand battery tray, through the access hole in the side panel of the UPS, and attach to the ground stud in the UPS cabinet (see Figure 3-10). Hardware is provided on each ground stud.
15. If installing additional battery cabinets, repeat Steps 2 through 13 to join each additional battery cabinet; otherwise, proceed to Step 15.
16. If not already installed, mount the hanger brackets to the top left side of the last battery cabinet using M4 screws (see Figure 3-11).
17. If not already installed, hang the side panel on the hanger brackets and align with the front and rear of the battery cabinet.
18. If not already secured, secure the side panel at the bottom using M4 hex-head screws previously removed.
19. Proceed to paragraph 3.4.2.

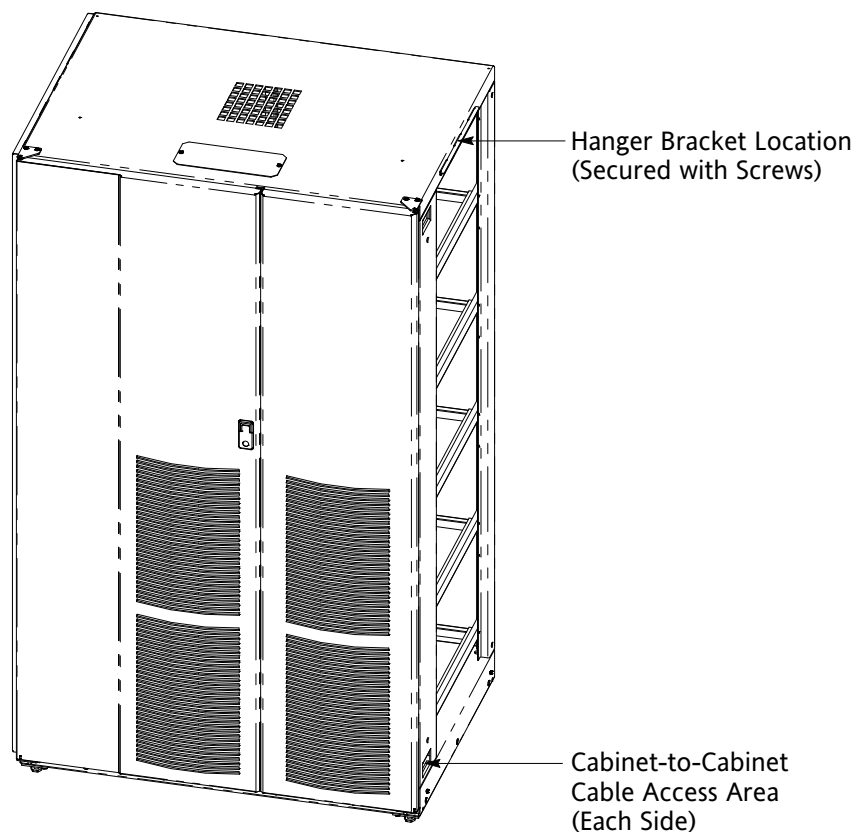

**Figure 3-11. IBC-L Battery Cabinet Hanger Brackets**

### 3.4.2 Line-up-and-Match IBC-L Electrical Connections

Use this procedure to wire an line-up-and-match battery cabinet to the Powerware 9390 UPS cabinet. All battery cabinets arrive at the site with each battery connection string electrically disconnected. If you are installing more than one battery cabinet, the battery cabinet adjacent to the UPS will be the only cabinet directly connected to the UPS.

#### **DANGER**



**LETHAL VOLTAGE** is present when performing the remaining steps in this section and subsequent sections.

1. Locate the battery cabinet-to-battery cabinet breaker sensing cable in the first battery cabinet. Route this connector into the cabinet to the immediate left and mate with the matching connector in that cabinet (see Drawing 164201536-8 on page A-17).
2. If installing multiple battery cabinets, proceed to Step 3; otherwise, proceed to Step 5.
3. On first and middle battery cabinet TB1 terminal boards, disconnect jumper from terminal 4 and connect to terminal 5. On last battery cabinet TB1 terminal board, verify jumper is connected between terminals 4 and 10. See Drawings 164201536-3 and 164201536-8.
4. Proceed to Step 6.
5. On battery cabinet TB1 terminal board, verify jumper is connected between terminals 4 and 10. See Drawings 164201536-3 and 164201536-8.
6. Locate the battery wiring harness under the bottom tray in the first battery cabinet. Route this harness into the cabinet to the immediate left and connect the (+) lead to the (+) battery terminal and the (-) lead to the (-) battery terminal (see Drawing 164201536-7 starting on page A-14). Use pressure and bus bar terminations, as necessary, for connecting cables between the battery cabinets.
7. Repeat Steps 1 through 6 for each battery cabinet, and then proceed to Step 8.
8. Locate the UPS-to-battery cabinet breaker sensing cable inside the first battery cabinet. Mate the connector on this cable with the matching connector in the cabinet (see Drawing 164201536-8 on page A-17). Route the other end of this cable into the UPS cabinet and connect to terminal strip TB2. Refer to the appropriate Powerware 9390 UPS Installation and Operation Manual, as referenced in paragraph 1.6, for UPS cabinet terminal locations.

9. A UPS-to-battery wiring harness is supplied inside the first battery cabinet. Use pressure and bus bar terminations, as necessary, for connecting cables between the UPS and battery cabinet. Connect and route cables from positive (+) and negative (–) terminals in the bottom of the first battery cabinet into the UPS cabinet. Connect the (+) lead to terminal E4 (+) and the (–) to terminal E5 (–) in the UPS cabinet. Refer to the appropriate Powerware 9390 UPS Installation and Operation Manual, as referenced in paragraph 1.6, for UPS cabinet terminal locations.
10. Verify that all battery breakers are in the OFF position.
11. Connect the string of battery trays by mating the loose red connector from each tray to the fixed black connector mounted on the front edge of the tray above. Connect the top and bottom tray connectors to the mating cabinet connectors to complete the battery string connections (see Figure 3-6).
12. Repeat Step 10 for each battery cabinet, and then proceed to Step 13.
13. Replace the doors that were removed in paragraph 3.2.
14. Secure all battery cabinets by closing and latching the doors.
15. Once the battery cabinets are installed and wired, return to the appropriate Powerware 9390 UPS Installation and Operation Manual, as referenced in paragraph 1.6, to complete the UPS wiring.

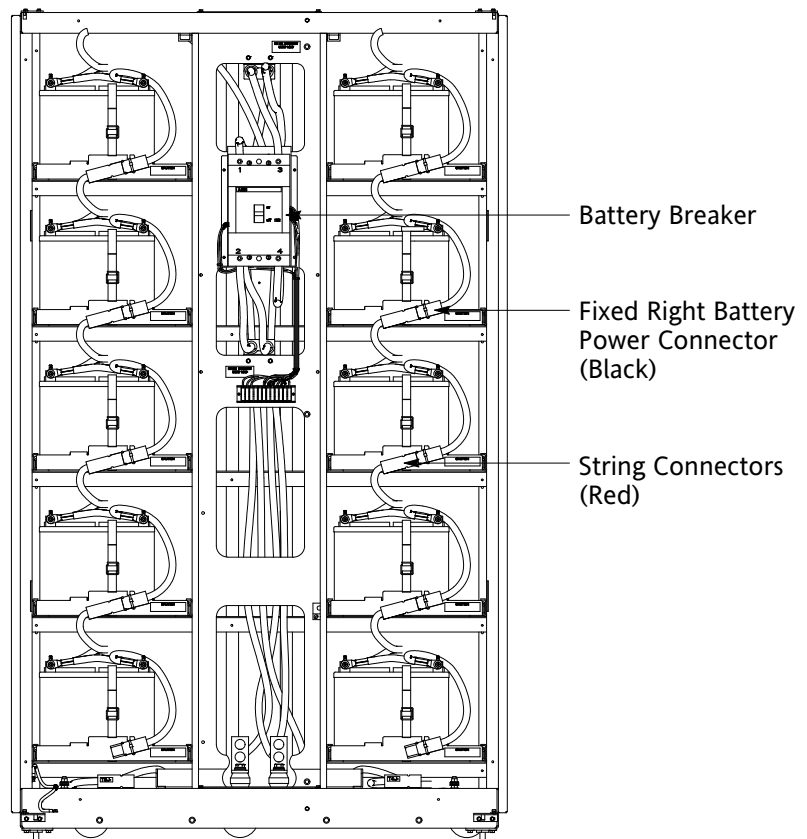

**Figure 3-12. IBC-L Battery String Connection**

### 3.4.3 Standalone IBC-L Installation

Use this procedure to install a standalone battery cabinet (see Figure 3-13).

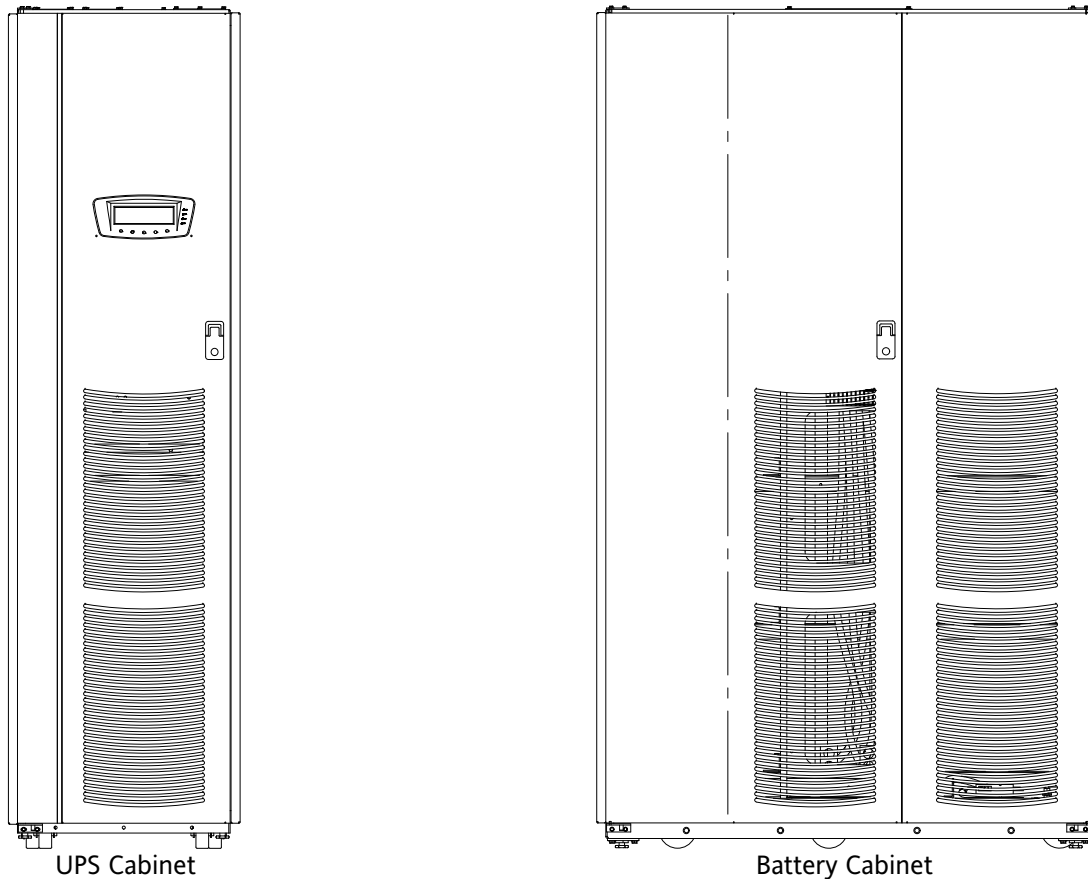

**Figure 3-13. UPS with Standalone IBC-L**

1. Verify that the UPS is properly installed and secured. Refer to the appropriate Powerware 9390 UPS Installation and Operation Manual, as referenced in paragraph 1.6, for installation instructions.
2. Roll the battery cabinet to the area where the battery cabinet is to be installed.
3. Secure the battery cabinet position by lowering the leveling feet until cabinet is not resting on the casters and the cabinet is level.
4. Remove the field kit. The field kit is attached with cable ties to the frame inside the door. Retain the field kit for later use.
5. If installing more than one battery cabinet, proceed to Step 6; otherwise, proceed to paragraph 3.4.4.



**NOTE** When a UPS system is ordered together with battery cabinets for standalone (remote) installation, the first battery cabinet is supplied with two cosmetic covers. Additional battery cabinets are supplied without cosmetic covers. Cosmetic covers must be ordered for the UPS cabinet and/or other ancillary cabinets.

6. Remove the cosmetic cover and hanger brackets from the appropriate side or sides of the battery cabinets, depending on the position of the cabinets. Save covers, screws, and brackets for later use.
7. Roll the next battery cabinet to be joined to an area near the appropriate side of the first battery cabinet.
8. Push the battery cabinet to be joined towards the first battery cabinet until the doors are flush with each other.
9. Secure the battery cabinet position by lowering the leveling feet until the cabinet is not resting on the casters. Ensure the cabinet is level and matches the height of the first installed battery cabinet.



---

**NOTE** *Two cabinet joining brackets are provided for securing each cabinet at the top and bottom. A flat bracket joins the top of the cabinets and a larger flat bracket joins the cabinets at the bottom. The small flat bracket is attached to the cabinet tops first.*

---

10. Remove the left-hand and right-hand screws from the adjacent top door hinges of the battery cabinets.
11. Locate the small flat bracket from the field kit. Align the holes in the small flat bracket over the hinge screw holes. Replace the screws in the hinges, securing the bracket to the cabinets (see Figure 3-9).
12. Locate the large flat bracket from the field kit. Place the bracket over the bolts on the bottom side of the adjacent lower hinges on the battery cabinets (see Figure 3-10).
13. Secure the bracket to the hinges with hardware from the field kit.
14. Route the ground wire (from the field kit) from the ground stud in one battery cabinet, under the lower battery tray and through the cabinet-to-cabinet cable access area in the side of the cabinets, and attach to the ground stud in the other battery cabinet (see Figure 3-10 and Figure 3-11). Hardware is provided on each ground stud.
15. If installing additional battery cabinets, repeat Steps 6 through 13 to join each additional battery cabinet; otherwise, proceed to Step 15.
16. If not already installed, mount the hanger brackets to the top appropriate side of the last battery cabinet using M4 screws (see Figure 3-5).
17. If not already installed, hang the side panel on the hanger brackets and align with the front and rear of the battery cabinet.
18. If not already secured, secure the side panel at the bottom using M4 hex-head screws previously removed.
19. Proceed to paragraph 3.4.4.

### 3.4.4 Standalone Battery Cabinet Electrical Connections

Use this procedure to wire a standalone battery cabinet to the Powerware 9390 UPS cabinet. All battery cabinets arrive at the site with each battery connection string electrically disconnected. If you are installing more than one battery cabinet, the first battery cabinet will be the only cabinet directly connected to the UPS.



#### DANGER

**LETHAL VOLTAGE** is present when performing the remaining steps in this section and subsequent sections.

1. Locate the battery breaker sensing cable in the right-hand battery cabinet. Route this connector into the cabinet to the immediate left and mate with the matching connector in that cabinet (see Drawing 164201536-8 on page A-17).
2. If installing multiple battery cabinets, proceed to Step 3; otherwise, proceed to Step 5.
3. On first and middle battery cabinet TB1 terminal boards, disconnect jumper from terminal 4 and connect to terminal 5. On last battery cabinet TB1 terminal board, verify jumper is connected between terminals 4 and 10. See Drawings 164201536-3 and 164201536-8.
4. Proceed to Step 6.
5. On battery cabinet TB1 terminal board, verify jumper is connected between terminals 4 and 10. See Drawings 164201536-3 and 164201536-8.
6. Locate the battery wiring harness under the bottom tray in the right-hand battery cabinet. Route this harness into the cabinet to the immediate left and connect the (+) lead to the (+) battery terminal and the (–) lead to the (–) battery terminal (see Drawing 164201536-7 starting on page A-14). Use pressure and bus bar terminations, as necessary, for connecting cables between the battery cabinets.
7. Repeat Steps 1 through 6 for each battery cabinet, and then proceed to Step 8.
8. Refer to the following to connect the external wiring from the first battery cabinet to the UPS cabinet:
  - a. See Drawing 164201536-5 on page A-9 to size wire for connecting the battery cabinets to the remotely located UPS cabinet.
  - b. See Drawing 164201536-6 starting on page A-12 for battery cabinet top or bottom conduit landing locations.
  - c. See Drawing 164201536-7 on page A-14 for location of positive (+) and negative (–) terminals.
  - d. Refer to the appropriate Powerware 9390 UPS Installation and Operation Manual, as referenced in paragraph 1.6, for top or bottom conduit landing locations.

9. Locate the UPS-to-battery cabinet breaker sensing cable inside the first battery cabinet. Mate the connector on this cable with the matching connector in the cabinet (see Drawing 164201536-8 on page A-17). Route the other end of this cable through conduit (top or bottom entry) to UPS cabinet and connect to terminal strip TB2. Refer to the appropriate Powerware 9390 UPS Installation and Operation Manual, as referenced in paragraph 1.6, for UPS cabinet terminal locations.
10. Use pressure and bus bar terminations, as necessary, for connecting cables between the UPS and battery cabinet. Connect and route cables from positive (+) and negative (-) terminals in the bottom of the first battery cabinet through conduit (top or bottom entry) to UPS cabinet terminals E4 and E5.
11. Verify that all battery breakers are in the OFF position.
12. Connect the string of battery trays by mating the loose red connector from each tray to the fixed black connector mounted on the front edge of the tray above. Connect the top and bottom tray connectors to the mating cabinet connectors to complete the battery string connections (see Figure 3-6).
13. Repeat Step 11 for each battery cabinet, and then proceed to Step 14.
14. Replace the doors that were removed in paragraph 3.2.
15. Secure all battery cabinets by closing and latching the doors.
16. After the battery cabinets are installed and wired, return to the appropriate Powerware 9390 UPS Installation and Operation Manual, as referenced in paragraph 1.6, to complete the UPS wiring.



## 3.5 Completing the Installation Checklist

The final step in installing your battery cabinet is to complete the Installation Checklist. This checklist ensures that you have installed all hardware, cables, and other equipment. Completing all items on the checklist will ensure a smooth installation. Make a copy of the Installation Checklist before filling it out, and retain the original.

After completing your installation, a service representative will be able to verify the operation of your battery cabinet, and commission it to support your critical load. The service representative cannot perform any installation tasks other than verifying that the battery cabinet has been correctly installed. Service personnel may request a copy of the completed Installation Checklist to be sure you have completed all applicable equipment installation requirements.



---

**NOTE** *The Installation Checklist MUST be completed prior to starting the UPS system for the first time.*

---

### Installation Checklist

- All packing materials and restraints have been removed from each cabinet.
- Each cabinet in the battery system is placed in its correct location.
- All cabinets are bolted together.
- A ground wire is installed between all cabinets that are bolted together.
- All conduits and cables are properly routed to the battery cabinets.
- A ground conductor is properly installed.
- Battery cables and harness are terminated on the E4 and E5 terminals in the UPS cabinet.
- Internal battery cabinet connections have been completed (cables, plugs, etc.).
- The EMP is installed and setup by an authorized Powerware Customer Service Engineer.
- Air conditioning equipment is installed and operating correctly.
- The area around the installed battery system is clean and dust-free. (It is recommended that the battery cabinet be installed on a sealed concrete pad or a sealed concrete floor.)
- Adequate working area exists around the battery cabinet and other cabinets.
- Adequate lighting is provided around all battery cabinet equipment.
- A remote battery disconnect control is mounted in its installed location and its wiring is terminated inside the battery cabinet (OPTIONAL).

## Notes

---

---

---

---

---

---

---

---

---

---

---

---

---

---

---

---

---

---

---

---

---

---

---

---

**This page intentionally left blank.**

## Appendix A | Installation Information

The information in this appendix helps during the planning and installation of the UPS battery system. This appendix contains the following drawings:

- ▶ 164201536-1 Powerware 9390 Integrated Battery Cabinets (IBC)
- ▶ 164201536-2 Physical Features and Requirements
- ▶ 164201536-3 Battery Cabinet Schematics
- ▶ 164201536-4 Battery System Oneline Drawings
- ▶ 164201536-5 Battery Wiring Installation Notes
- ▶ 164201536-6 Conduit and Wire Entry Locations Standalone Battery Cabinets
- ▶ 164201536-7 Battery Power and Interface Terminal Locations
- ▶ 164201536-8 Interface Wiring Installation Notes and Terminal Connections
- ▶ 164201536-9 Battery Cabinet Dimensions

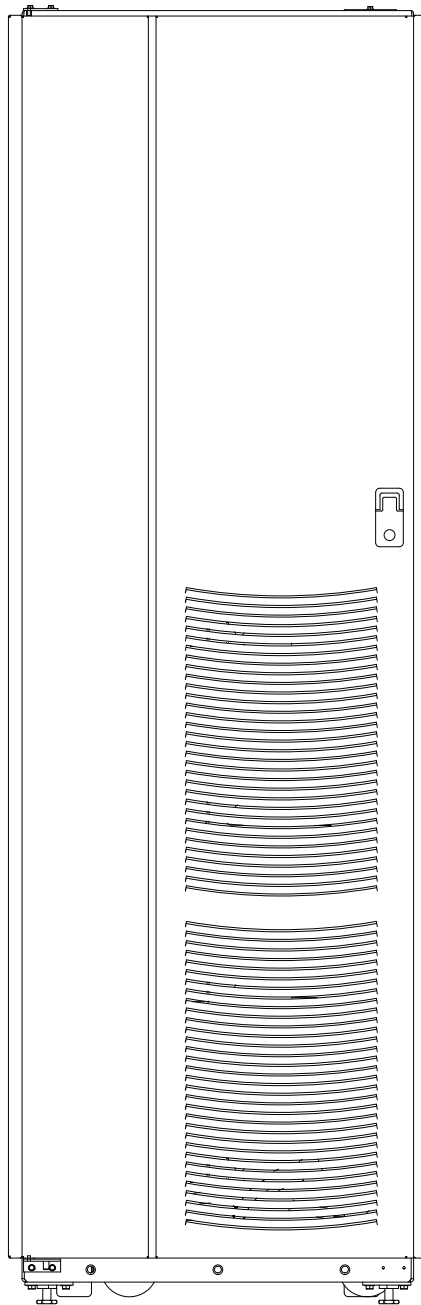

**MODEL IBC-S**

DESCRIPTION:	<b>POWERWARE 9390 INTEGRATED BATTERY CABINETS (IBC)</b>	
DRAWING NO:	164201536-1	SHEET: 1 of 2
REVISION:	B	DATE: 091504

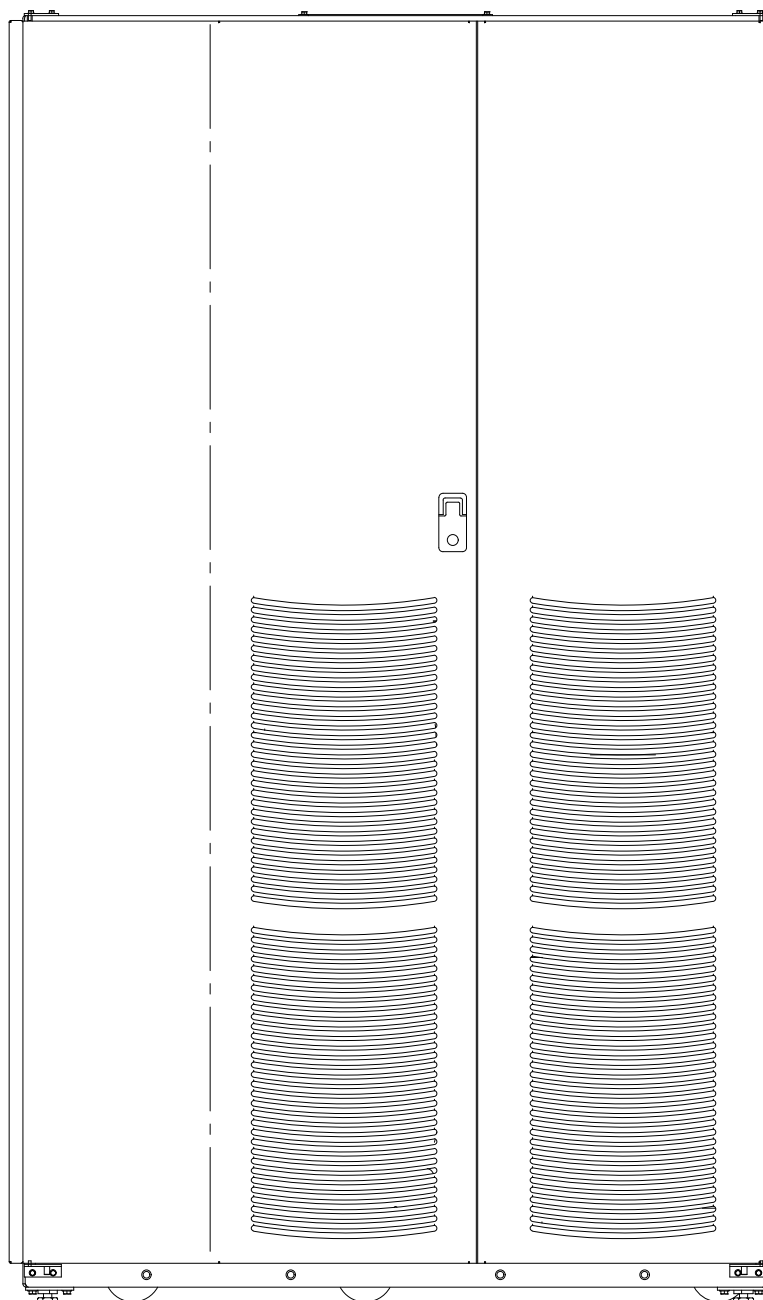

**MODEL IBC-L**

DESCRIPTION:	<b>POWERWARE 9390 INTEGRATED BATTERY CABINETS (IBC)</b>	
DRAWING NO:	164201536-1	SHEET: 2 of 2
REVISION:	B	DATE: 091504

1. The battery cabinet operating environment must meet the weight requirements shown in Table A and size requirements shown on Drawing 164201536–9.
2. The battery cabinets are palletted separately for shipping.
3. Do not tilt cabinets more than  $\pm 10^\circ$  during handling.
4. Dimensions are in millimeters (inches).

<b>Table A. Equipment Weight</b>			
Component	Weight kg (lb)		
	Shipping	Installed	Point Loading
IBC–S with 32 batteries (384 VDC)	837 (1845)	807 (1780)	4 at 202 (445)
IBC–S with 36 batteries (432 VDC)	909 (2005)	880 (1940)	4 at 220 (485)
IBC–S with 40 batteries (480 VDC)	982 (2165)	953 (2100)	4 at 238 (525)
IBC–L with 32 batteries (384 VDC)	1848 (4075)	1814 (4000)	8 at 227 (500)
IBC–L with 36 batteries (432 VDC)	2029 (4475)	1995 (4400)	8 at 249 (550)
IBC–L with 40 batteries (480 VDC)	2211 (4875)	2177 (4800)	8 at 272 (600)

5. The clearances required around the battery cabinets are shown in Table B.

<b>Table B. Battery Cabinet Clearances</b>	
From Top of Cabinet	Minimum clearance over the battery cabinet is 457.2 mm (18 in.) for ventilation
From Front of Cabinet	36 inches (0.9144m) working space
From Back of Cabinet	None required
From Right Side of Cabinet	None required
From Left Side of Cabinet	None required

6. The basic environmental requirements of both Models IBC–S and IBC–L for operation of the UPS system are:

**Operational Temperature Range:** 22–28°C (72–82°F)

**Maximum Relative Humidity:** 95%, noncondensing

**CAUTION:** It is recommended for optimal battery life and discharge performance to keep the ambient air temperature the battery is used in at 25°C (77°F).

<i>DESCRIPTION:</i> <b>PHYSICAL FEATURES AND REQUIREMENTS</b>		
<i>DRAWING NO:</i>	164201536–2	<i>SHEET:</i> 1 of 1
<i>REVISION:</i>	B	<i>DATE:</i> 070804

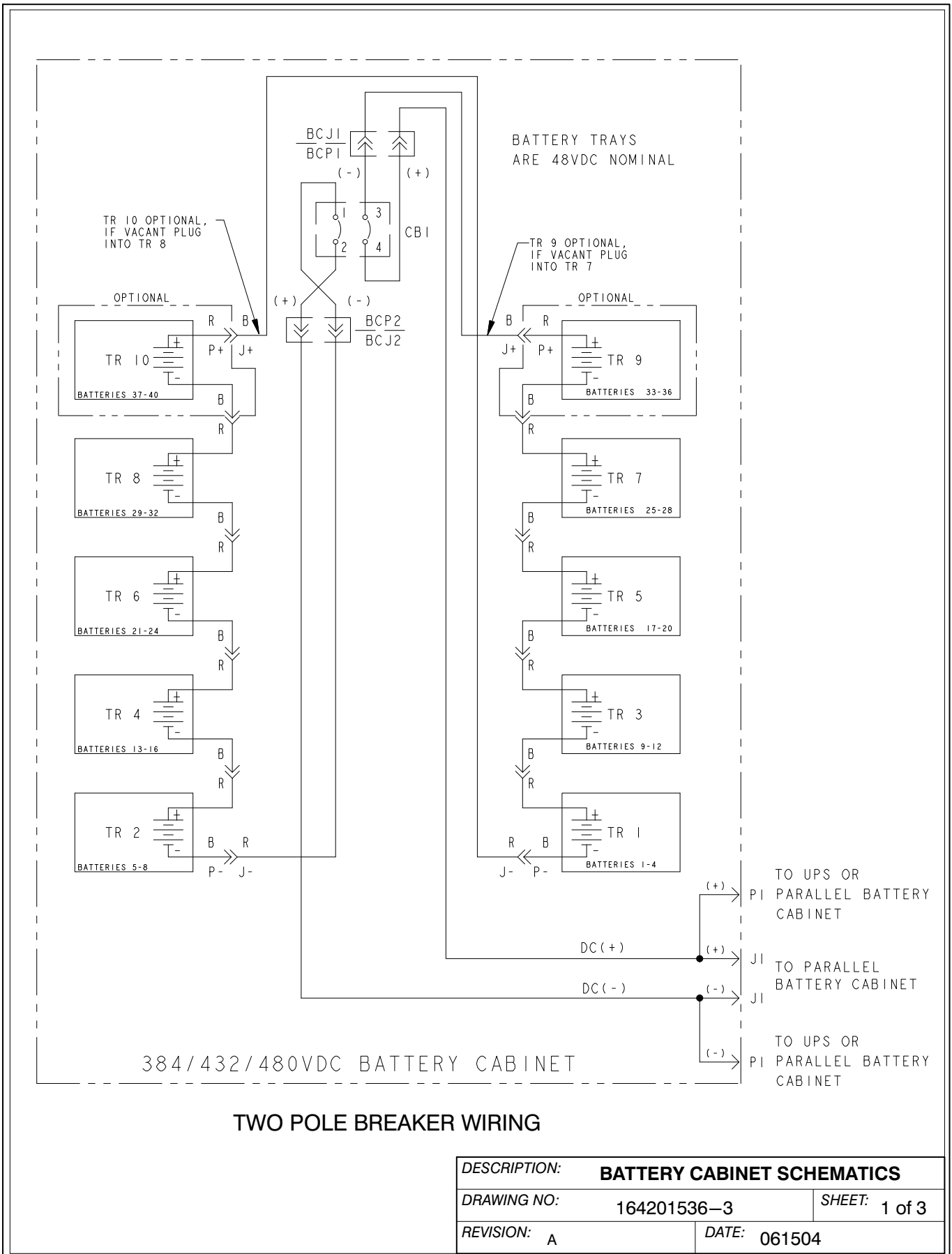



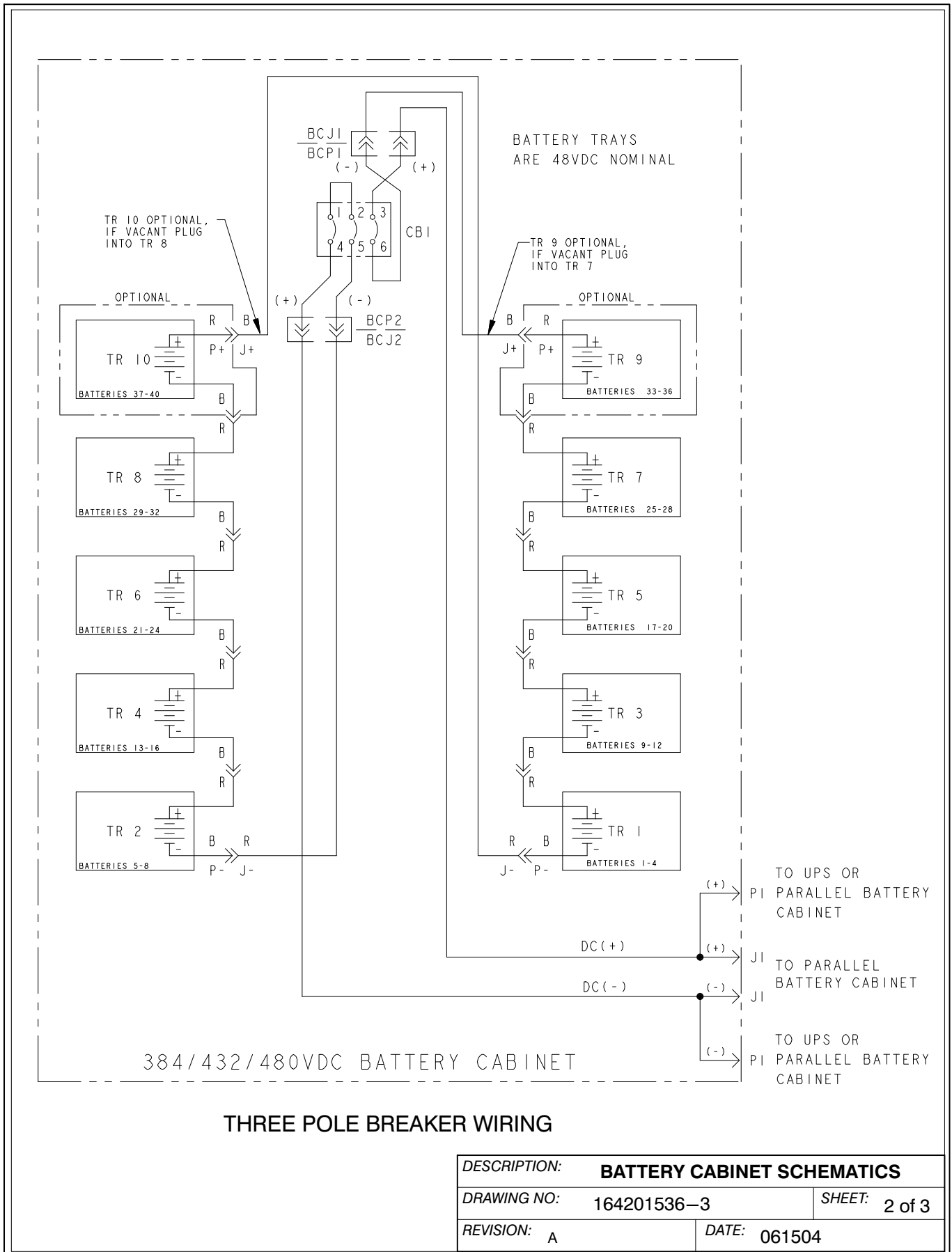

DESCRIPTION: <b>BATTERY CABINET SCHEMATICS</b>	
DRAWING NO: 164201536-3	SHEET: 2 of 3
REVISION: A	DATE: 061504

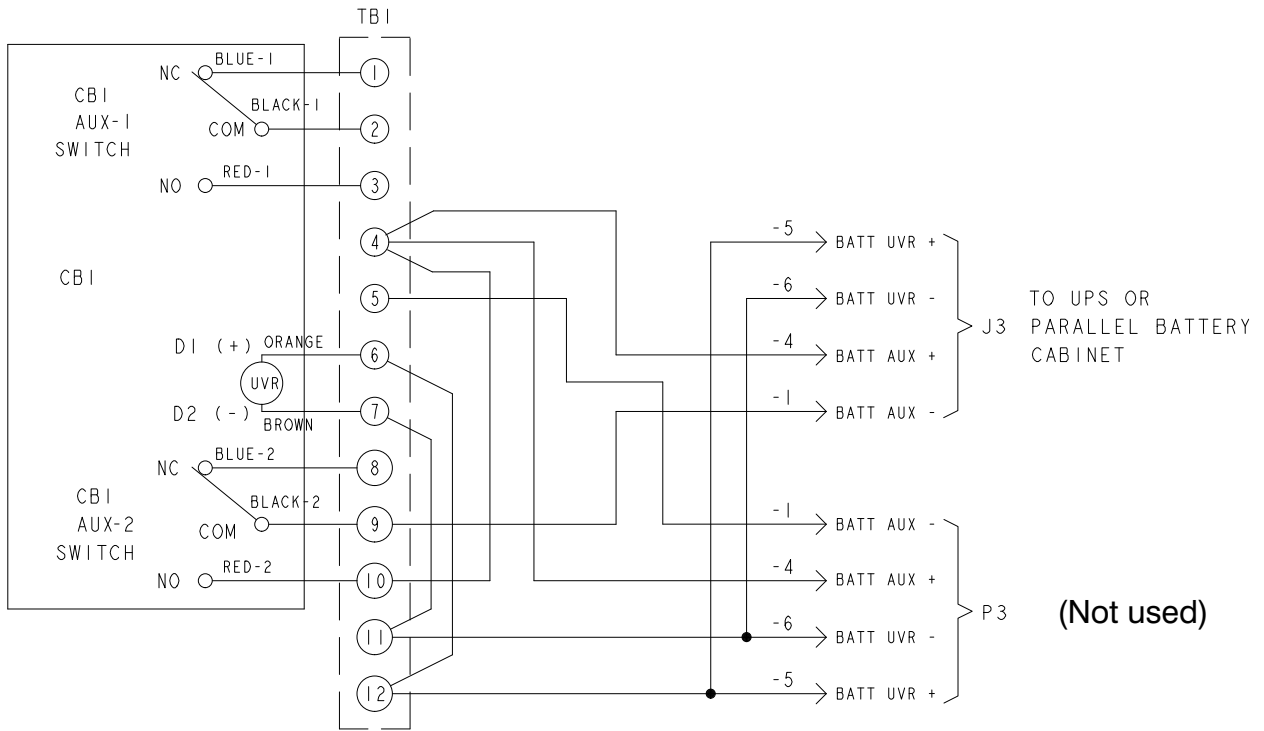

SINGLE CABINET INSTALLATIONS AND LAST CABINET IN MULTI-CABINET INSTALLATIONS

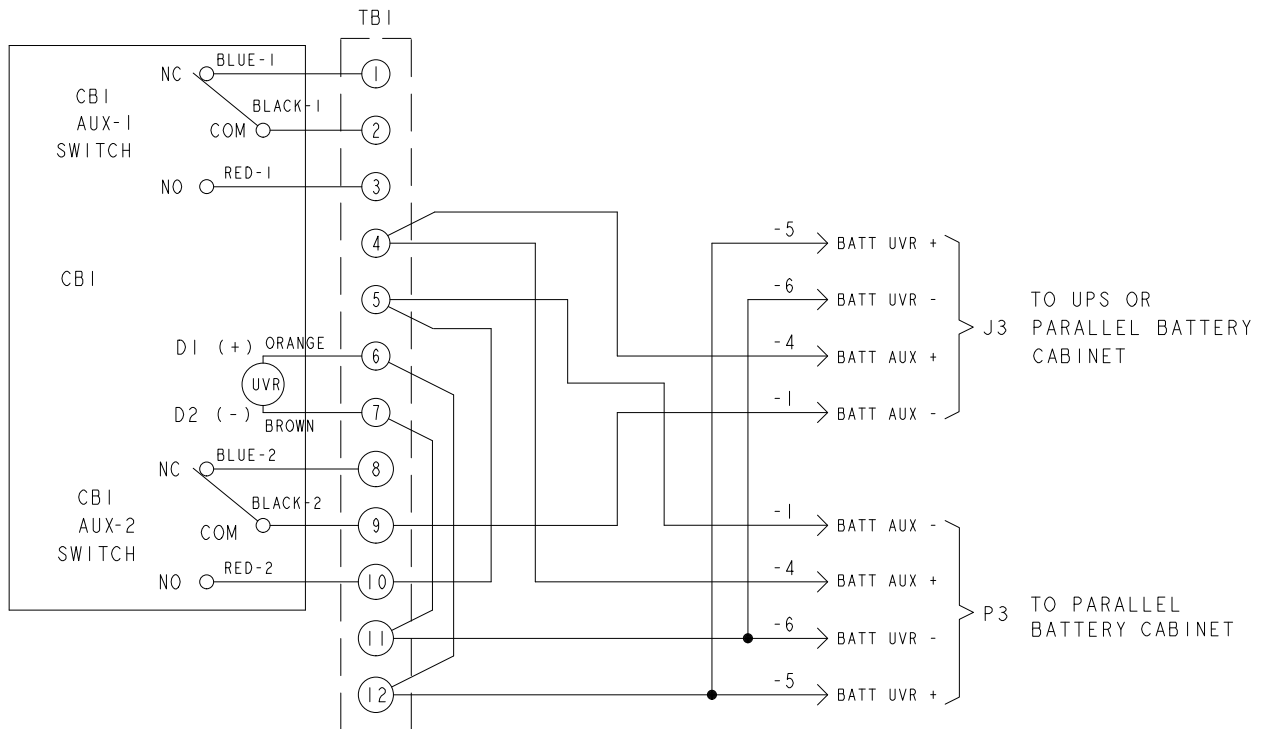

FIRST AND MIDDLE CABINETS IN MULTI-CABINET INSTALLATIONS

BATTERY BREAKER CB1 CONTROL

DESCRIPTION:	<b>BATTERY CABINET SCHEMATICS</b>	
DRAWING NO:	164201536-3	SHEET: 3 of 3
REVISION:	B	DATE: 091504

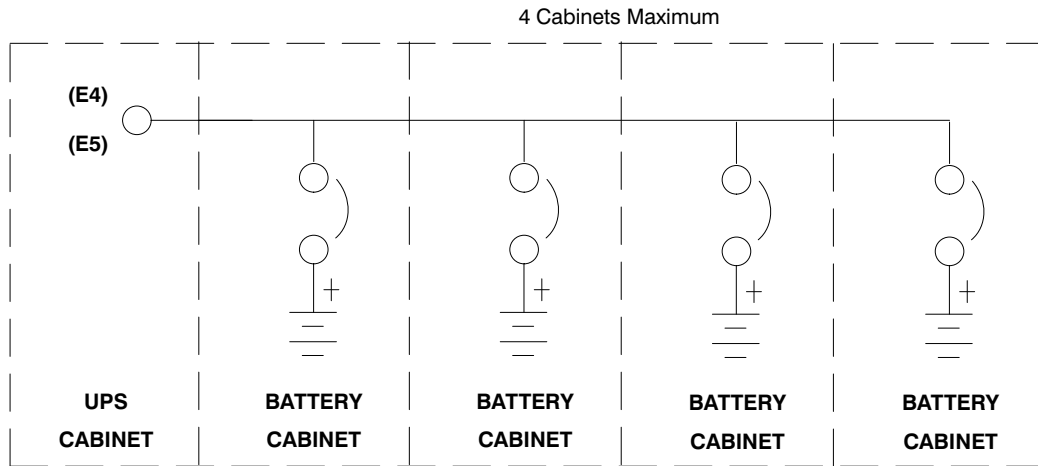

Powerware 9390 40 kVA through 160 kVA  
 Battery Cabinets integral to UPS  
 and connected using factory-supplied wiring

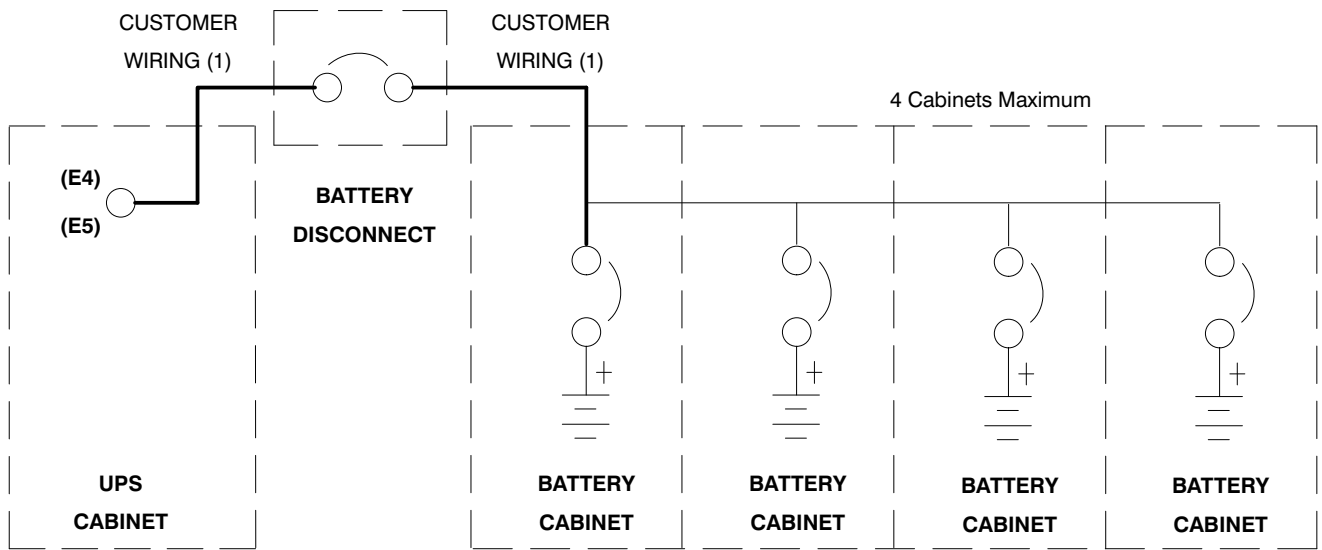

Powerware 9390 40 kVA through 160 kVA  
 Battery Cabinets located separately from the UPS

- NOTES:** 1. See Drawing 164201536–5 for wiring installation notes.  
 2. Customer wiring (1): See Table D to size customer supplied wiring.

<b>DESCRIPTION: BATTERY SYSTEM ONLINE DRAWINGS</b>		
<b>DRAWING NO:</b>	164201536–4	<b>SHEET:</b> 1 of 1
<b>REVISION:</b>	B	<b>DATE:</b> 093004

1. Refer to NEC Article 250 and local codes for proper grounding practices.
2. The battery cabinet frame is not referenced to the DC circuit.
3. Battery voltage is computed at 2 volts per cell as defined by Article 480 of the NEC. Rated battery current is computed at 1.8 volts per cell.
4. The battery wiring used between the battery and the UPS should not allow a voltage drop of more than 1% of nominal DC voltage at rated battery current.
5. A battery disconnect switch is recommended, and may be required by NEC or local codes when batteries are separately located. The battery disconnect switch may be supplied as an accessory, and should be installed between the battery cabinet(s) and the UPS.
6. If the conductors used for DC input from the battery cabinet(s) to the UPS are those provided by the UPS manufacturer, and the UPS and battery cabinet are manufactured by the same supplier, then it is acceptable if they do not meet the noted minimum conductor sizes.
7. Each battery cabinet can be installed as a line-up-and-match or standalone system. The term *line-up-and-match* refers to battery cabinets that are physically attached to the UPS, share internal wiring, and use the battery cabinet breaker as the battery isolation device. The term *standalone* refers to battery cabinets that are not physically attached to the UPS, are wired with external contractor-supplied wiring, and use a single disconnect device located near the battery cabinet(s). Each battery cabinet has its own overcurrent protection device with a built-in UVR feature that must be used in all configurations.
8. Refer to the appropriate Powerware 9390 UPS Installation and Operation Manual, as referenced in paragraph 1.6, for UPS cabinet conduit and terminal locations, and terminal specifications.
9. The Environmental Monitoring Probe (EMP), for remote monitoring of battery environmental conditions, must be installed and set up by an Eaton Customer Service Representative, or the extended battery warranty terms specified on page W–1 will be void.
10. The external ground wire requirements are shown in Table C.

**Table C. External Ground Wire Requirements for Battery Cabinets**

UPS Model	Battery Type	Number of Cabinets	Line-up-and-Match or Separate Battery	Wire Size	Size and Type Screw	Torque Nm (lb in)
all	all	all	all	1/0	7/16" slot	5.6 (50)

<b>DESCRIPTION: BATTERY WIRING INSTALLATION NOTES</b>	
<b>DRAWING NO:</b> 164201536–5	<b>SHEET:</b> 1 of 3
<b>REVISION:</b> B	<b>DATE:</b> 093004

**11.** The battery cabinet external wiring requirements are shown in Tables D and E.

<b>Table D. Battery Cabinet External Wiring and Termination Requirements (UPS-to-Battery, Battery-to-Battery, or Remote Disconnect to Battery) for Powerware 9390 Model IBC-S</b>								
UPS Model kVA	Battery Type	Number of Cabinets	Cabinet Position	Wire Size UPS to Battery	Wire Size Battery to Battery	Terminations	Torque Nm (lb in)	Size and Type Screw
40 and 50	Note 2	1, 2, 3, or 4	Line-up-and-Match	Supplied 1 per Pole	Supplied 1 per Pole	1 – #6–500 kcmil 2 – 1 Bolt Mounting	56.5 (500) 22.6 (200)	1/2" Allen 3/8" Hex nut
40 and 50	Note 2	1, 2, 3, or 4	Stand alone	1/0 1 per Pole	1/0 1 per Pole	1 – #6–500 kcmil 2 – 1 Bolt Mounting	56.5 (500) 22.6 (200)	1/2" Allen 3/8" Hex nut
60	Note 2	1, 2, 3, or 4	Line-up-and-Match	Supplied 1 per Pole	Supplied 1 per Pole	1 – #6–500 kcmil 2 – 1 Bolt Mounting	56.5 (500) 22.6 (200)	1/2" Allen 3/8" Hex nut
60	Note 2	1, 2, 3, or 4	Stand alone	2/0 1 per Pole	2/0 1 per Pole	1 – #6–500 kcmil 2 – 1 Bolt Mounting	56.5 (500) 22.6 (200)	1/2" Allen 3/8" Hex nut
80	Note 2	1, 2, 3, or 4	Line-up-and-Match	Supplied 1 per Pole	Supplied 1 per Pole	1 – #6–500 kcmil 2 – 1 Bolt Mounting	56.5 (500) 22.6 (200)	1/2" Allen 3/8" Hex nut
80	Note 2	1, 2, 3, or 4	Stand alone	3/0 1 per Pole	3/0 1 per Pole	1 – #6–500 kcmil 2 – 1 Bolt Mounting	56.5 (500) 22.6 (200)	1/2" Allen 3/8" Hex nut

NOTE 1: All specified wire sizes are 90°C rated copper minimum.

NOTE 2: Replace with same type and number of original battery. Mixing battery letter designation and or sizes will damage equipment and void warranty.

<b>DESCRIPTION: BATTERY WIRING INSTALLATION NOTES</b>	
DRAWING NO: 164201536-5	SHEET: 2 of 3
REVISION: C	DATE: 032406

**Table E. Battery Cabinet External Wiring and Termination Requirements (UPS-to-Battery, Battery-to-Battery, or Remote Disconnect to Battery) for Powerware 9390 Model IBC-L**

UPS Model kVA	Battery Type	Number of Cabinets	Cabinet Position	Wire Size UPS to Battery	Wire Size Battery to Battery	Terminations	Torque Nm (lb in)	Size and Type Screw or Bolt
40 and 50	Note 2	1, 2, 3, or 4	Line-up-and-Match	Supplied 1 per Pole	Supplied 1 per Pole	2 – #2–600 kcmil 2 – 1 Bolt Mounting	42.4 (375) 22.6 (200)	3/8" Hex M10 Hex
40 and 50	Note 2	1, 2, 3, or 4	Stand alone	1/0 1 per Pole	1/0 1 per Pole	2 – #2–600 kcmil 2 – 1 Bolt Mounting	42.4 (375) 22.6 (200)	3/8" Hex M10 Hex
60	Note 2	1, 2, 3, or 4	Line-up-and-Match	Supplied 1 per Pole	Supplied 1 per Pole	2 – #2–600 kcmil 2 – 1 Bolt Mounting	42.4 (375) 22.6 (200)	3/8" Hex M10 Hex
60	Note 2	1, 2, 3, or 4	Stand alone	2/0 1 per Pole	2/0 1 per Pole	2 – #2–600 kcmil 2 – 1 Bolt Mounting	42.4 (375) 22.6 (200)	3/8" Hex M10 Hex
80	Note 2	1, 2, 3, or 4	Line-up-and-Match	Supplied 1 per Pole	Supplied 1 per Pole	2 – #2–600 kcmil 2 – 1 Bolt Mounting	42.4 (375) 22.6 (200)	3/8" Hex M10 Hex
80	Note 2	1, 2, 3, or 4	Stand alone	3/0 1 per Pole	3/0 1 per Pole	2 – #2–600 kcmil 2 – 1 Bolt Mounting	42.4 (375) 22.6 (200)	3/8" Hex M10 Hex
100	Note 2	1, 2, 3, or 4	Line-up-and-Match	Supplied 2 per Pole	Supplied 2 per Pole	2 – #2–600 kcmil 2 – 1 Bolt Mounting	42.4 (375) 22.6 (200)	3/8" Hex M10 Hex
100	Note 2	1, 2, 3, or 4	Stand alone	2/0 2 per Pole	2/0 2 per Pole	2 – #2–600 kcmil 2 – 1 Bolt Mounting	42.4 (375) 22.6 (200)	3/8" Hex M10 Hex
120	Note 2	1, 2, 3, or 4	Line-up-and-Match	Supplied 2 per Pole	Supplied 2 per Pole	2 – #2–600 kcmil 2 – 1 Bolt Mounting	42.4 (375) 22.6 (200)	3/8" Hex M10 Hex
120	Note 2	1, 2, 3, or 4	Stand alone	3/0 2 per Pole	3/0 2 per Pole	2 – #2–600 kcmil 2 – 1 Bolt Mounting	42.4 (375) 22.6 (200)	3/8" Hex M10 Hex
160	Note 2	1, 2, 3, or 4	Line-up-and-Match	Supplied 2 per Pole	Supplied 2 per Pole	2 – #2–600 kcmil 2 – 1 Bolt Mounting	42.4 (375) 22.6 (200)	3/8" Hex M10 Hex
160	Note 2	1, 2, 3, or 4	Stand alone	250 kcmil 2 per Pole	250 kcmil 2 per Pole	2 – #2–600 kcmil 2 – 1 Bolt Mounting	42.4 (375) 22.6 (200)	3/8" Hex M10 Hex

NOTE 1: All specified wire sizes are 90°C rated copper minimum.

NOTE 2: Replace with same type and number of original battery. Mixing battery letter designation and or sizes will damage equipment and void warranty.

<b>DESCRIPTION: BATTERY WIRING INSTALLATION NOTES</b>	
DRAWING NO: 164201536-5	SHEET: 3 of 3
REVISION: C	DATE: 032406

**TOP VIEW**

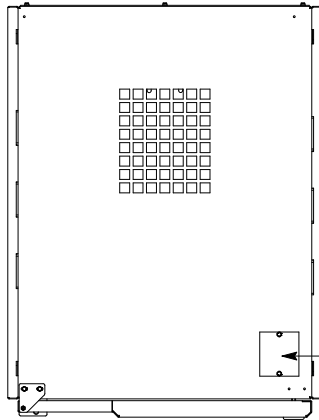

TOP ENTRY CONDUIT LANDING FOR DC OUTPUT, AND DC CONTROL INTERFACE CONNECTIONS. (REMOVE PANEL TO DRILL OR PUNCH CONDUIT HOLES.)

BOTTOM ENTRY CONDUIT LANDING FOR DC OUTPUT, AND DC CONTROL INTERFACE CONNECTIONS. (REMOVE PANEL TO DRILL OR PUNCH CONDUIT HOLES.)

**BOTTOM VIEW**

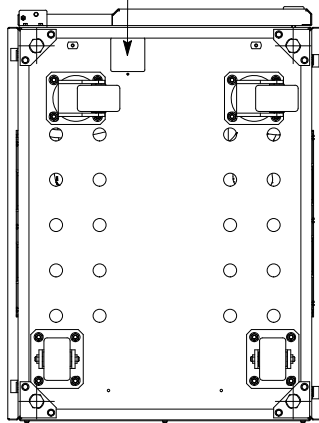

**MODEL IBC-S**

<b>DESCRIPTION: CONDUIT AND WIRE ENTRY LOCATIONS STAND-ALONE BATTERY CABINETS</b>		
<b>DRAWING NO:</b>	164201536-6	<b>SHEET:</b> 1 of 2
<b>REVISION:</b>	B	<b>DATE:</b> 091504

**TOP VIEW**

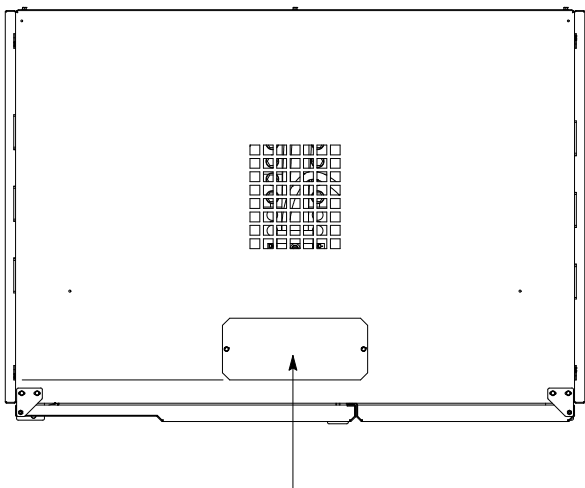

TOP ENTRY CONDUIT LANDING FOR DC OUTPUT, AND DC CONTROL INTERFACE CONNECTIONS.  
(REMOVE PANEL TO DRILL OR PUNCH CONDUIT HOLES.)

BOTTOM ENTRY CONDUIT LANDING FOR DC OUTPUT, AND DC CONTROL INTERFACE CONNECTIONS.  
(REMOVE PANEL TO DRILL OR PUNCH CONDUIT HOLES.)

**BOTTOM VIEW**

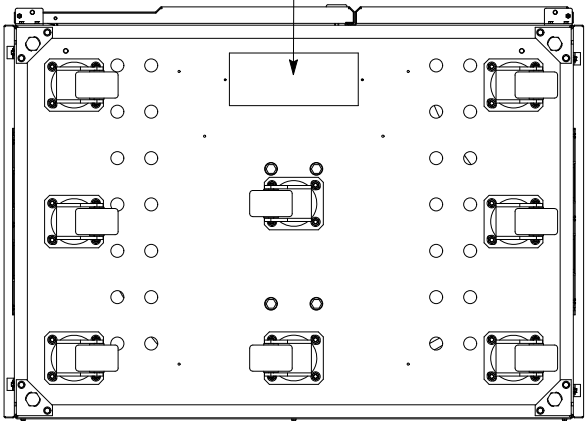

**MODEL IBC-L**

<b>DESCRIPTION: CONDUIT AND WIRE ENTRY LOCATIONS STAND-ALONE BATTERY CABINETS</b>		
<b>DRAWING NO:</b>	164201536-6	<b>SHEET:</b> 2 of 2
<b>REVISION:</b>	B	<b>DATE:</b> 091504



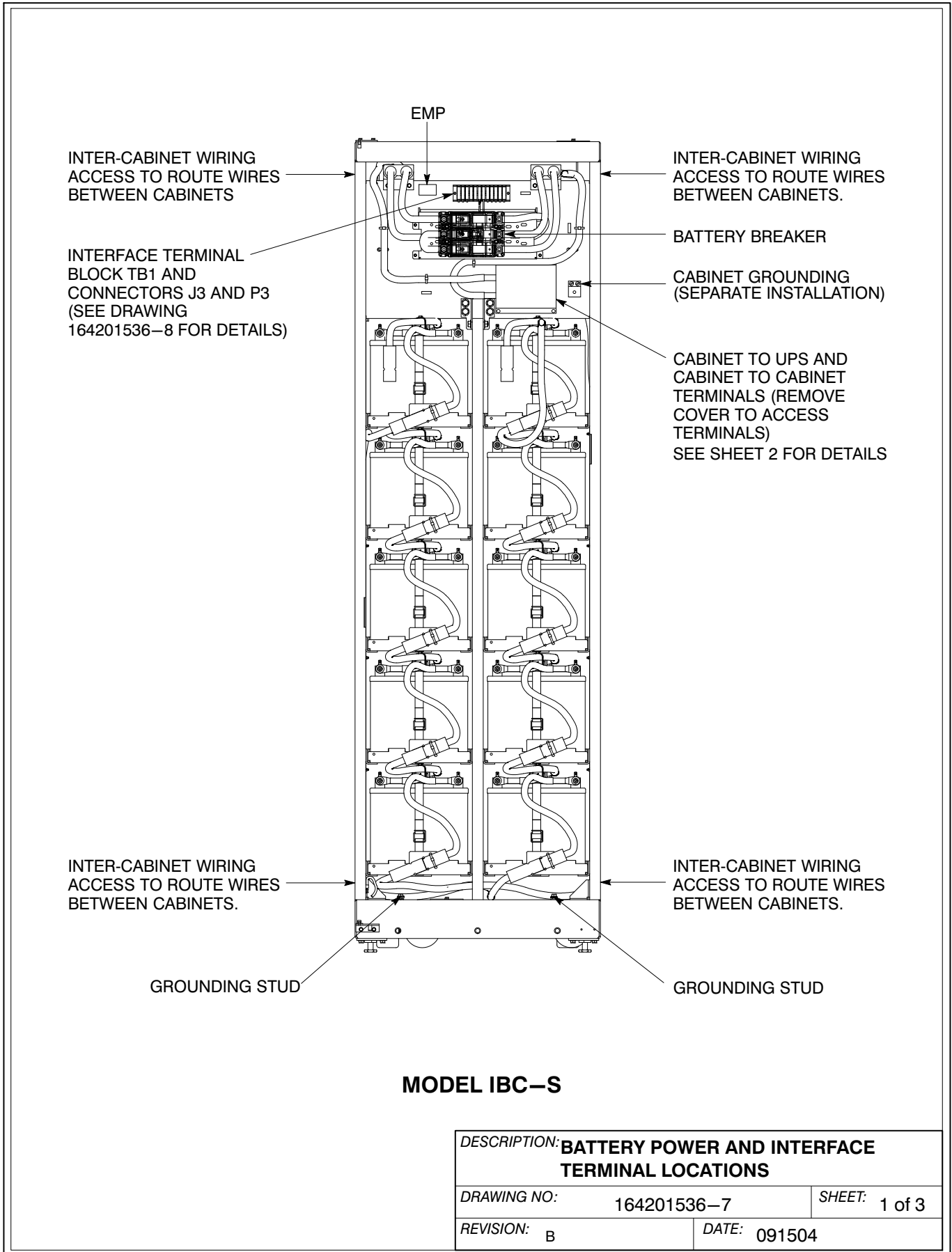

## TERMINAL DETAIL

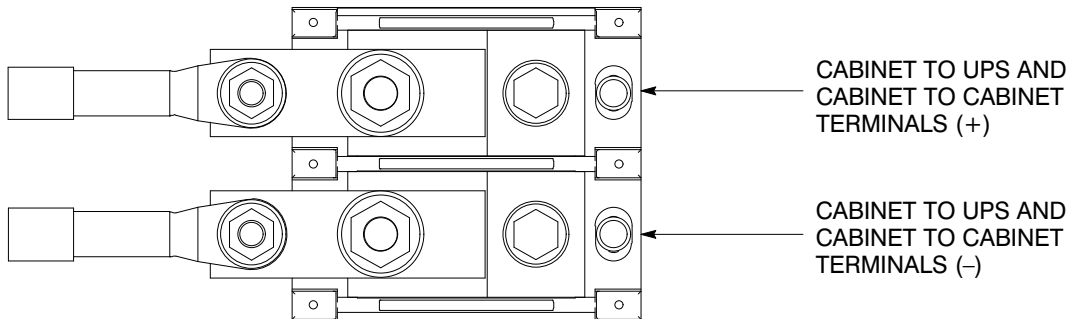

### MODEL IBC-S

**NOTE:** Use pressure and bus bar terminations, as necessary, for connecting cables between the UPS and battery cabinet and between battery cabinets.

DESCRIPTION: <b>BATTERY POWER AND INTERFACE TERMINAL LOCATIONS</b>		
DRAWING NO:	164201536-7	SHEET: 2 of 3
REVISION:	B	DATE: 091504

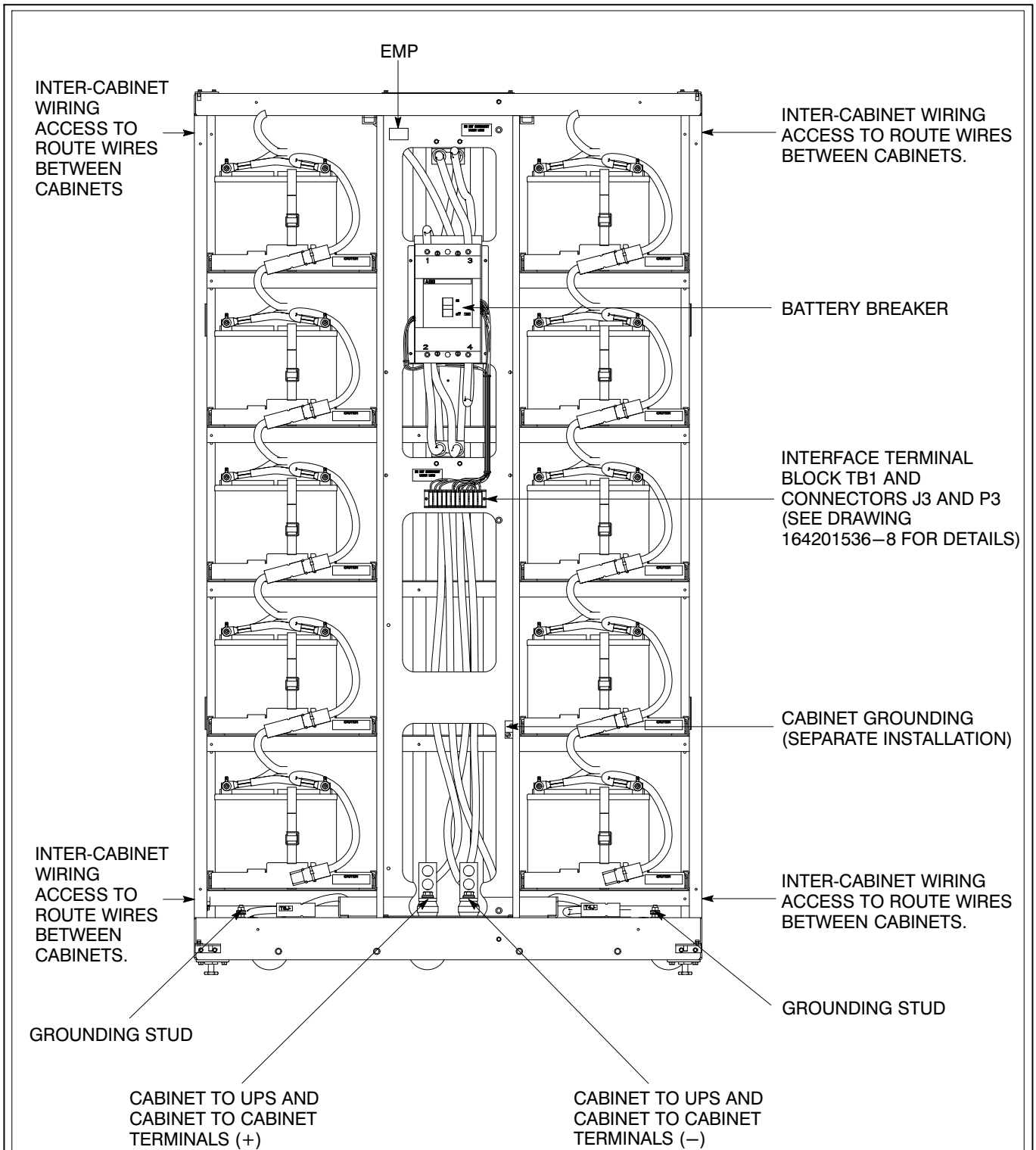

**MODEL IBC-L**

**NOTE:** Use pressure and bus bar terminations, as necessary, for connecting cables between the UPS and battery cabinet and between battery cabinets.

DESCRIPTION: <b>BATTERY POWER AND INTERFACE TERMINAL LOCATIONS</b>		
DRAWING NO:	164201536-7	SHEET: 3 of 3
REVISION:	B	DATE: 091504

1. Use Class 1 wiring methods (as defined by the NEC) for control wiring. Install the control wiring in separate conduit from the power wiring. The wire should be rated at 48V, 1A minimum.
2. Battery Aux and UVR wiring should be a minimum of 18 AWG.
3. UV trip requires 48V to activate.
4. Torque screw terminals to 20 lb in.
5. Auxiliary Contacts are rated as follows:
  - 240 VAC @ 15A
  - 125 VDC @ 0.3A
  - 250 VDC @ 0.15A

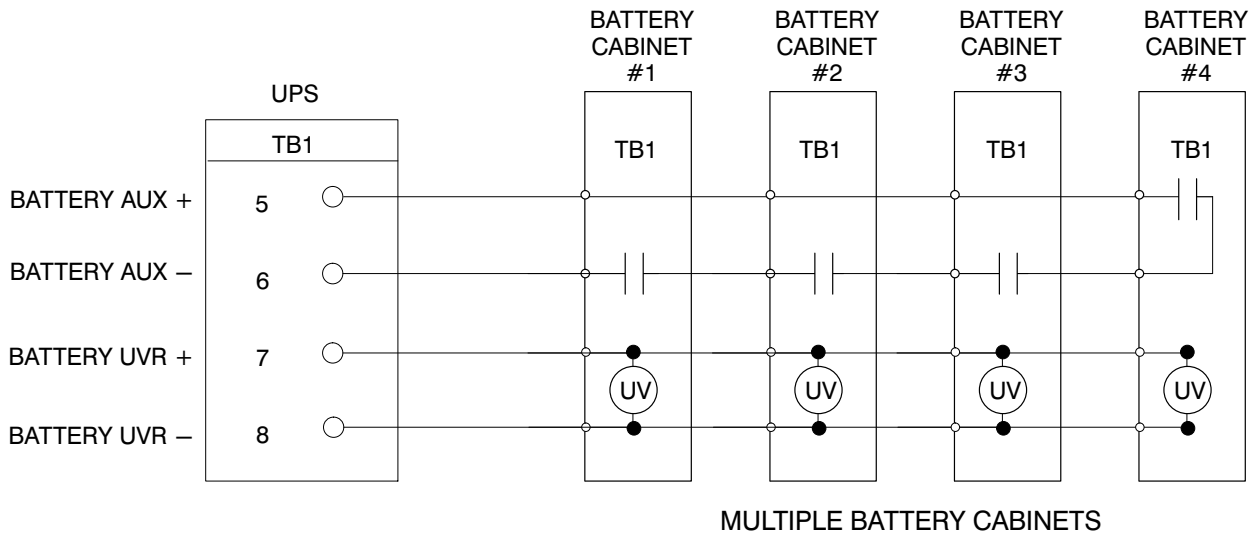
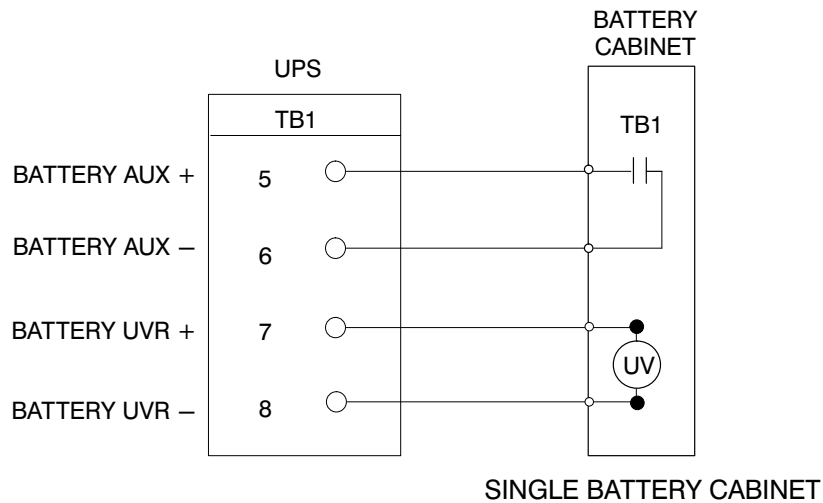

<b>DESCRIPTION: INTERFACE WIRING INSTALLATION</b>		
<b>NOTES AND TERMINAL CONNECTIONS</b>		
<b>DRAWING NO:</b>	164201536-8	<b>SHEET:</b> 1 of 2
<b>REVISION:</b>	C	<b>DATE:</b> 032406

6. Refer to Table F for TB1 interface connections.

Table F. TB1 Interface Connections		
Terminal TB1	Name	Description
1	CB1 Aux 1 Switch NC	Auxiliary battery breaker dry contacts. Not used.
2	CB1 Aux 1 Switch Com	
3	CB1 Aux 1 Switch NO	
4	Jumper Tie Points	Single or multi-cabinet selection
5		
6	Battery UVR +	Internal connection to UVR coil.
7	Battery UVR –	
8	CB1 Aux 2 NC	Auxiliary battery breaker dry contact. Not used.
9	CB1 Aux 2 Com	Contact used to indicate whether UPS battery breaker or disconnect is open or closed.
10	CB1 Aux 2 NO	
11	Battery UVR –	Contacts used to open battery breaker or disconnect.
12	Battery UVR +	

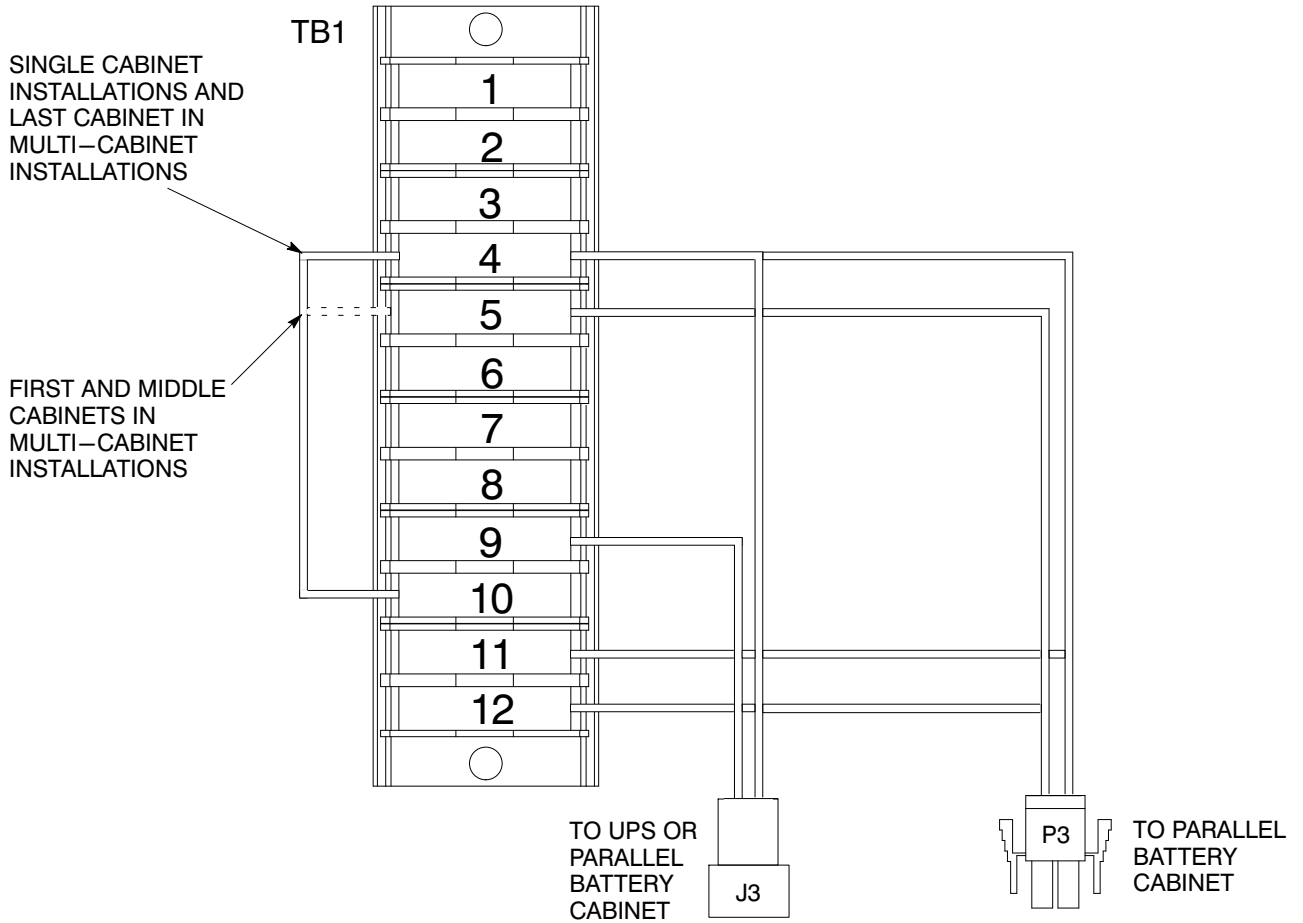

<b>DESCRIPTION: INTERFACE WIRING INSTALLATION NOTES AND TERMINAL CONNECTIONS</b>		
DRAWING NO:	164201536-8	SHEET: 2 of 2
REVISION:	B	DATE: 091504

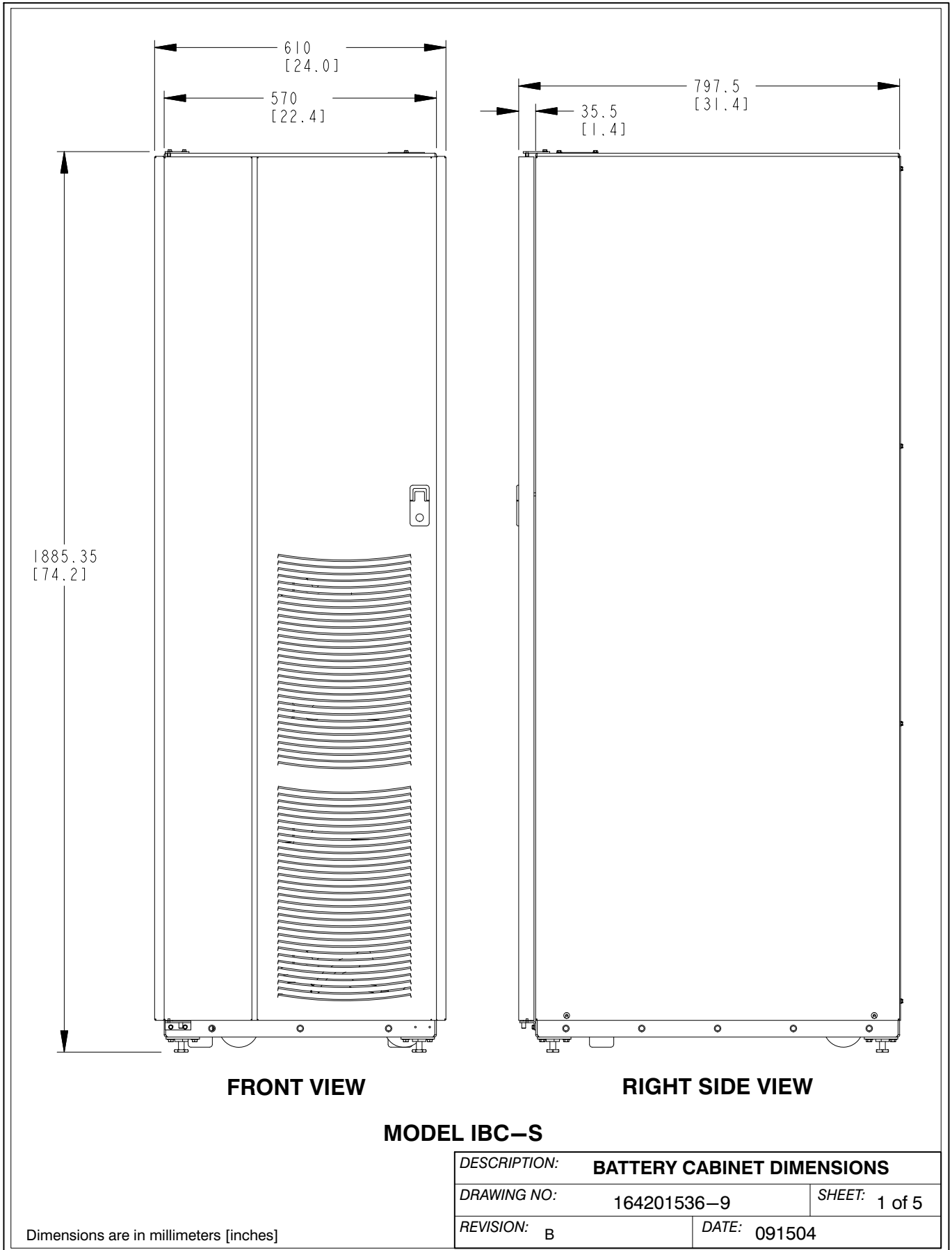

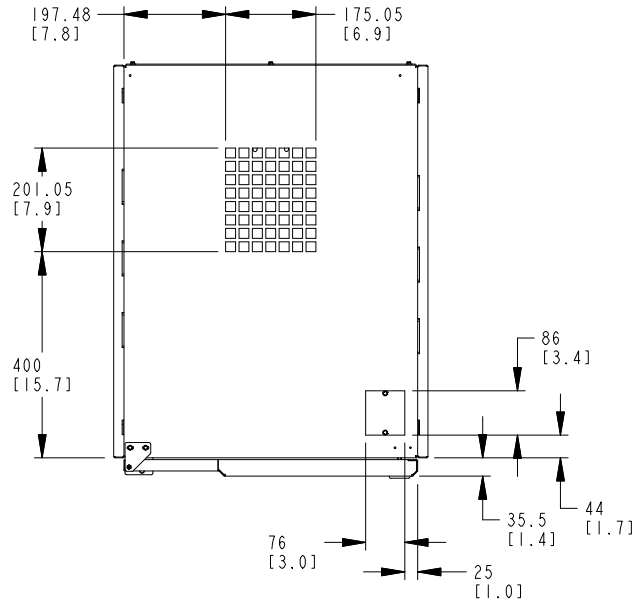

**TOP VIEW**

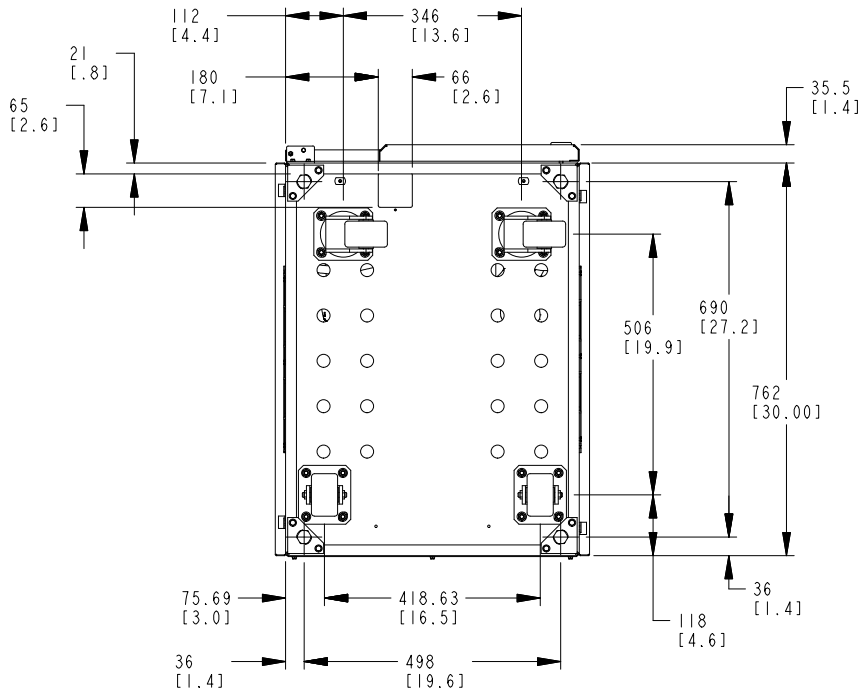

**BOTTOM VIEW**

**MODEL IBC-S**

DESCRIPTION: <b>BATTERY CABINET DIMENSIONS</b>	
DRAWING NO: 164201536-9	SHEET: 2 of 5
REVISION: B	DATE: 091504

Dimensions are in millimeters [inches]

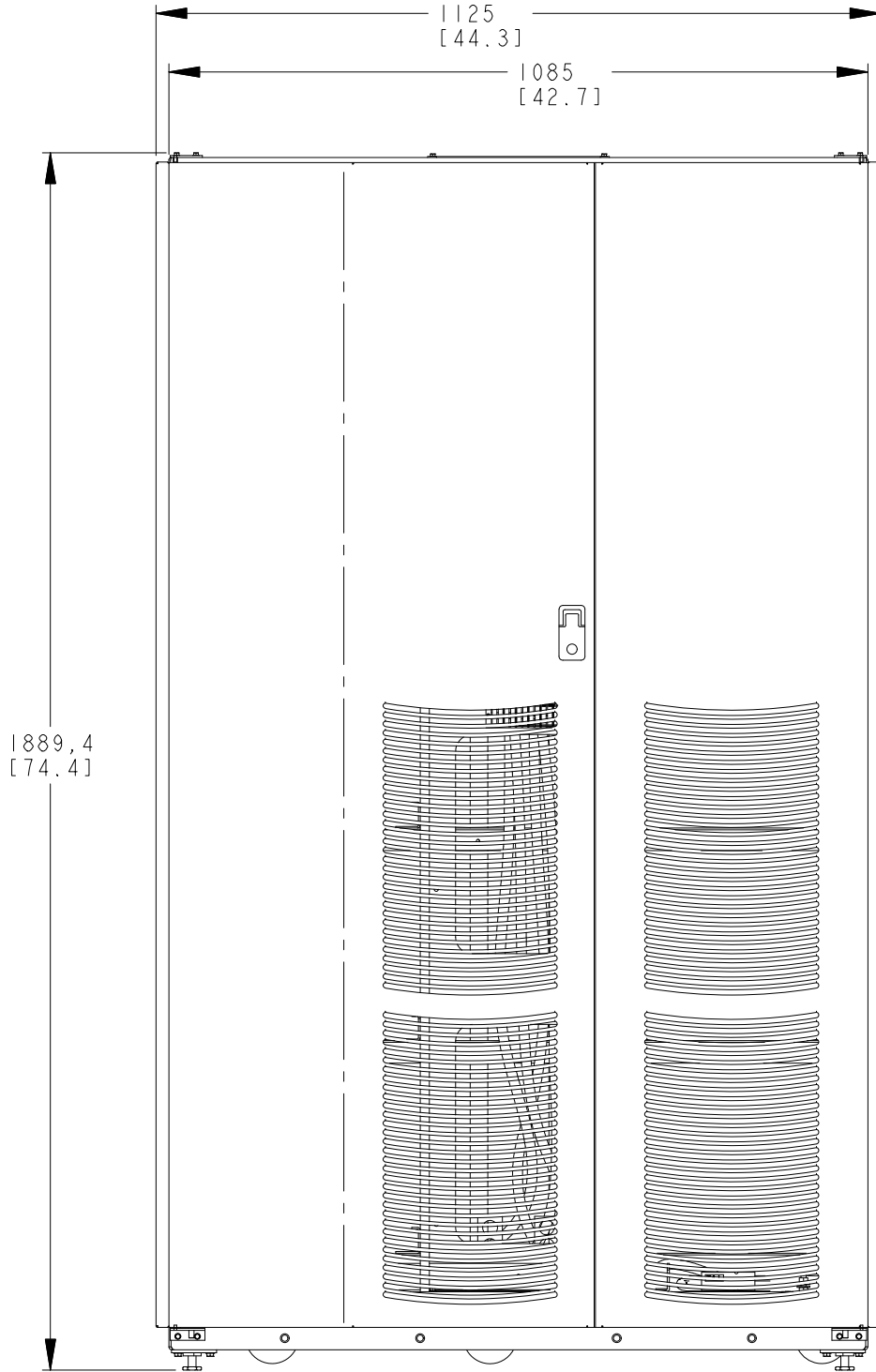

**FRONT VIEW**

**MODEL IBC-L**

DESCRIPTION:	<b>BATTERY CABINET DIMENSIONS</b>	
DRAWING NO:	164201536-9	SHEET: 3 of 5
REVISION:	B	DATE: 091504

Dimensions are in millimeters [inches]



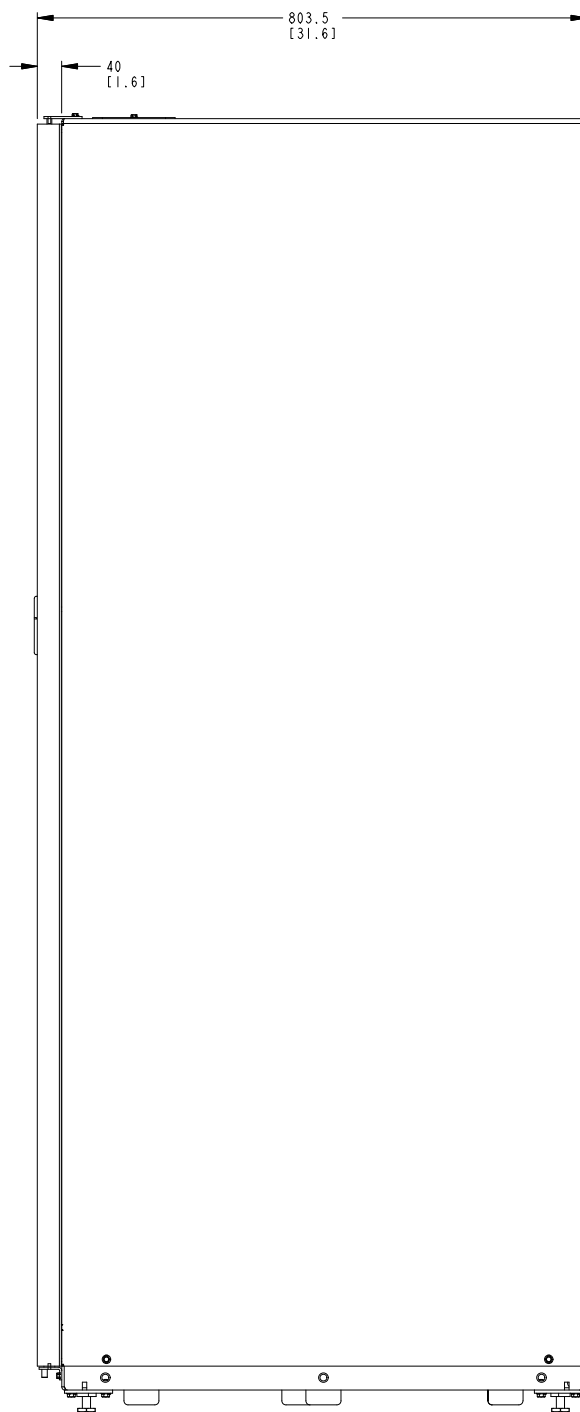

**RIGHT SIDE VIEW**  
**MODEL IBC-L**

<i>DESCRIPTION:</i> <b>BATTERY CABINET DIMENSIONS</b>	
<i>DRAWING NO:</i> 164201536-9	<i>SHEET:</i> 4 of 5
<i>REVISION:</i> B	<i>DATE:</i> 091504

Dimensions are in millimeters [inches]

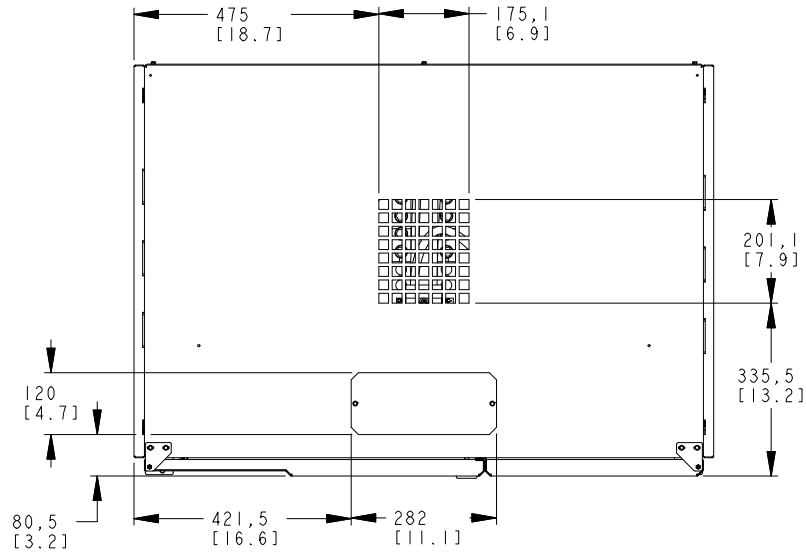

**TOP VIEW**

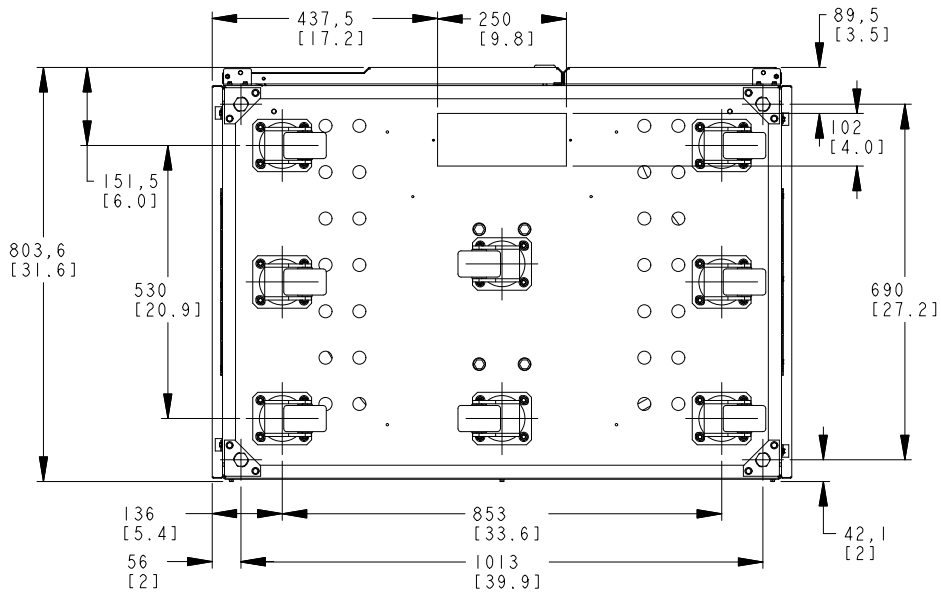

**BOTTOM VIEW**

**MODEL IBC-L**

DESCRIPTION:	<b>BATTERY CABINET DIMENSIONS</b>	
DRAWING NO:	164201536-9	SHEET: 5 of 5
REVISION:	B	DATE: 091504

Dimensions are in millimeters [inches]

**This page intentionally left blank.**

# Warranty

## LIMITED FACTORY WARRANTY FOR THREE-PHASE POWERWARE® PRODUCTS

**WARRANTOR:** The warrantor for the limited warranties set forth herein is Eaton Electrical Inc., a Delaware Corporation (“Eaton”).

**LIMITED WARRANTY:** This limited warranty (this “Warranty”) applies only to the original end-user (the “End-User”) of the Powerware Three-Phase UPS Products (the “Product”) and cannot be transferred. This Warranty applies even in the event that the Product is initially sold by Eaton for resale to an End-User.

**LIMITED WARRANTY PERIOD:** The period covered by this Warranty for Product installed [and currently located] in the fifty (50) United States and the District of Columbia is twelve (12) months from the date of Product start-up or eighteen (18) months from the date of Product shipment, whichever occurs first, for parts coverage and 90 days from the date of Product start-up for labor coverage. The period covered by this Warranty for Product installed [and currently located] outside of the fifty (50) United States and the District of Columbia is twelve (12) months from the date of Product start-up or eighteen (18) months from the date of Product shipment, whichever occurs first, for parts coverage.

**WHAT THIS LIMITED WARRANTY COVERS:** The warrantor warrants that the Powerware three-phase UPS electronics, Eaton-built accessories, and Powerware-built battery cabinets (individually and collectively, the “Warranted Items”) are free from defects in material and workmanship. If, in the opinion of Eaton, a Warranted Item is defective and the defect is within the terms of this Warranty, Eaton’s sole obligation will be to repair or replace such defective item (including by providing service, parts, and labor, as applicable), at the option of Eaton. The Warranted Item will be repaired or replaced onsite at the End-User’s location or such other location as determined by Eaton. Any parts that are replaced may be new or reconditioned. All parts replaced by Eaton shall become the property of Eaton.

**WHAT THIS LIMITED WARRANTY DOES NOT COVER:** This Warranty does not cover any defects or damages caused by: (a) failure to properly store the Product before installation, including the “trickle charge” of batteries no later than the date indicated on the packaging; (b) shipping and delivery of the Product if shipping is FOB Factory; (c) neglect, accident, abuse, misuse, misapplication, incorrect installation; (d) repair or alteration not authorized in writing by Eaton personnel or performed by an authorized Eaton Customer Service Engineer or Agent; or (e) improper testing, operation, maintenance, adjustment, or any modification of any kind not authorized in writing by Eaton personnel or performed by an authorized Eaton Customer Service Engineer or Agent.

This Warranty is not valid: (a) unless an authorized Eaton Customer Service Engineer (in the USA) or Agent (outside of the USA) performs startup and commissioning of the Product; (b) if the Product is moved to a new location by someone other than an authorized Eaton Customer Service Engineer (in the USA) or Agent (outside of the USA); or (c) if the Product’s serial numbers have been removed or are illegible. Any Warranted Items repaired or replaced pursuant to this Warranty will be warranted for the remaining portion of the original Warranty subject to all the terms thereof. Labor warranty is not provided for Product located outside of the fifty (50) United States or the District of Columbia. **Any equipment, parts, or materials included in the Product and not manufactured by Eaton are warranted solely by the manufacturer of such equipment, parts, or materials and are not included as part of this Warranty. Batteries are not warranted by Eaton.**

**THIS WARRANTY IS THE END-USER’S SOLE REMEDY AND IS EXPRESSLY IN LIEU OF, AND THERE ARE NO OTHER EXPRESSED OR IMPLIED GUARANTEES OR WARRANTIES (INCLUDING ANY IMPLIED WARRANTY OF MERCHANTABILITY OR FITNESS FOR ANY PURPOSE, WHICH ARE EXPRESSLY DISCLAIMED).**

**LIMITATION OF LIABILITY:** In no event shall Eaton be liable for any indirect, incidental, special, or consequential damages of any kind or type whatsoever, or based on any claim or cause of action, however denominated. Eaton shall not be responsible for failure to provide service or parts due to causes beyond Eaton’s reasonable control. In no case will Eaton’s liability under this Warranty exceed the replacement value of the Warranted Items.

**END-USER’S OBLIGATIONS:** In order to receive the benefits of this Warranty, the End-User must use the Product in a normal way, follow the Product’s operation and maintenance manual, and protect against further damage to the Product if there is a covered defect.

**OTHER LIMITATIONS:** Eaton’s obligations under this Warranty are expressly conditioned upon receipt by Eaton of all payments due to it (including interest charges, if any). During such time as Eaton has not received payment of any amount due to it for the Product, in accordance with the contract terms under which the Product is sold, Eaton shall have no obligation under this Warranty. Also during such time, the period of this Warranty shall continue to run and the expiration of this Warranty shall not be extended upon payment of any overdue or unpaid amounts.

**COSTS NOT RELATED TO WARRANTY:** The End-User shall be invoiced for, and shall pay for, all services not expressly provided for by the terms of this Warranty, including without limitation site calls involving an inspection that determines no corrective maintenance is required. Any costs for replacement equipment, installation, materials, freight charges, travel expenses, or labor of Eaton representatives outside the terms of this Warranty will be borne by the End-User.

**OBTAINING WARRANTY SERVICE:** In the USA, call the Eaton Customer Reliability Center 7x24 at 800-843-9433. Outside of the USA, call your local Eaton sales or service representative, or call the Eaton Customer Reliability Center in the USA at 919-870-3028. For comments or questions about this Limited Factory Warranty, write to the Customer Quality Representative, 3301 Spring Forest Road, Raleigh, North Carolina 27616 USA.

**This page intentionally left blank.**





164201536 D