



ИБП Eaton EX 2200 2U Rack/Tower - Eaton EX - Морской фильтр 3000 ВА - Установка и руководство

Постоянная ссылка на страницу: <https://eaton-power.ru/catalog/eaton-ex/eaton-ex-2200-2u-rack-tower/>

Marine Filter

3000 VA

Installation and user
manual

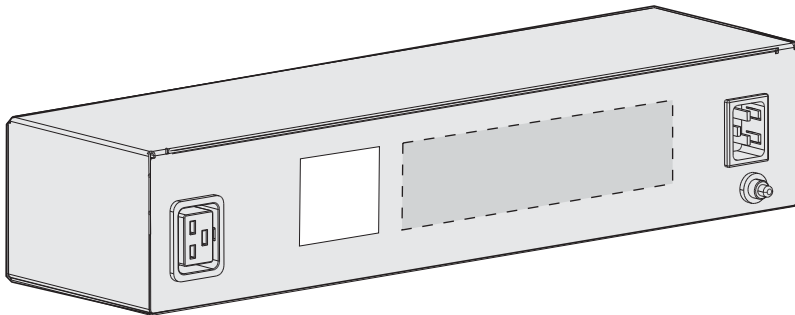

Powering Business Worldwide

Powering Business Worldwide



34008410/AD

www.eaton.com

Introduction

This product filters the low frequency noises produced by a UPS from 10 Hz to 150 KHz.

Packaging

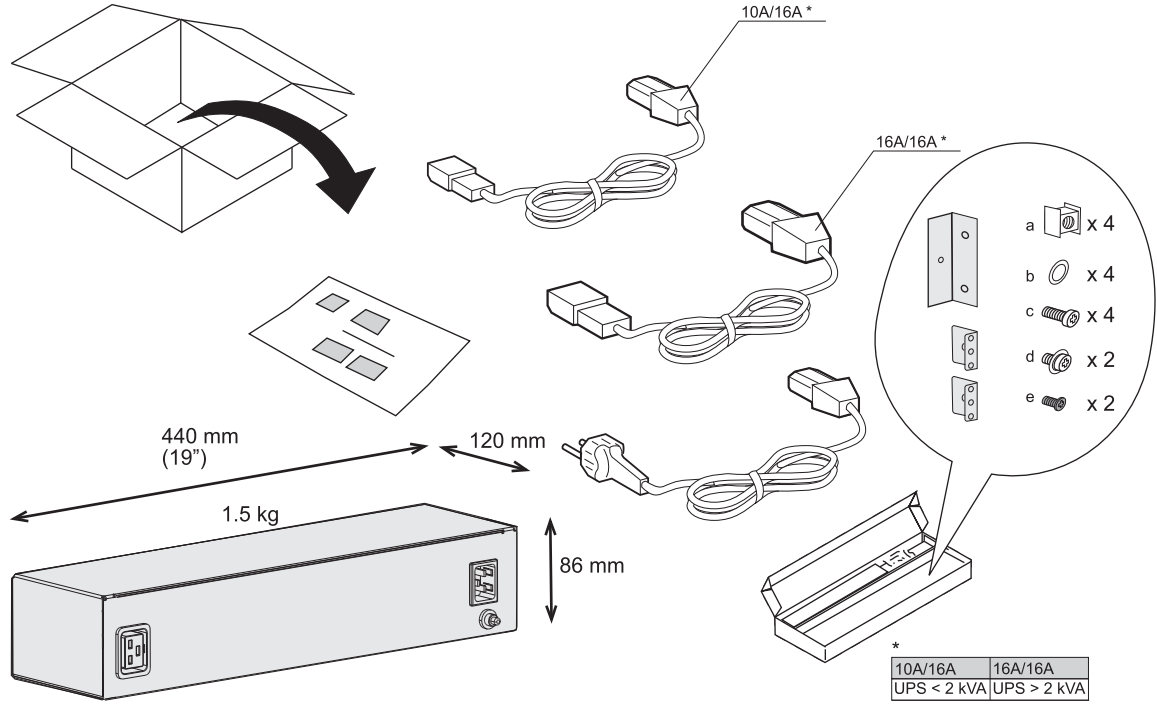

Installation

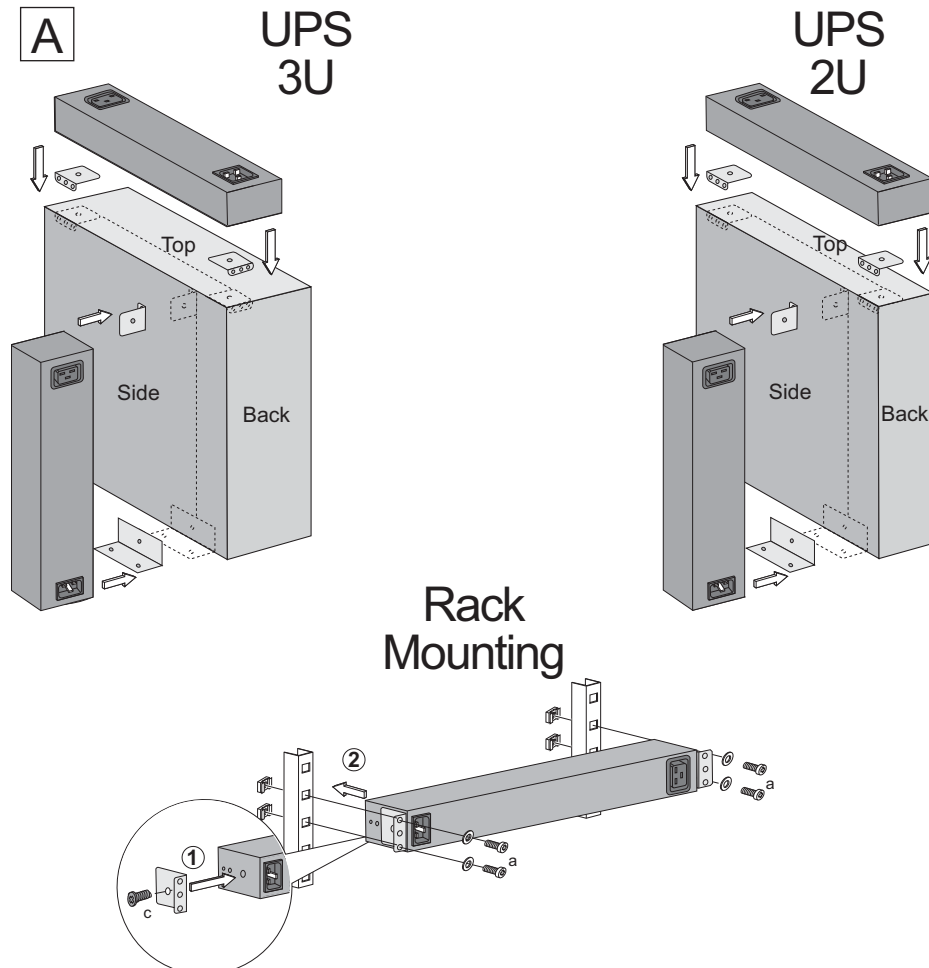

Installation

The socket-outlet shall be installed near the equipment and shall be easily accessible.

B

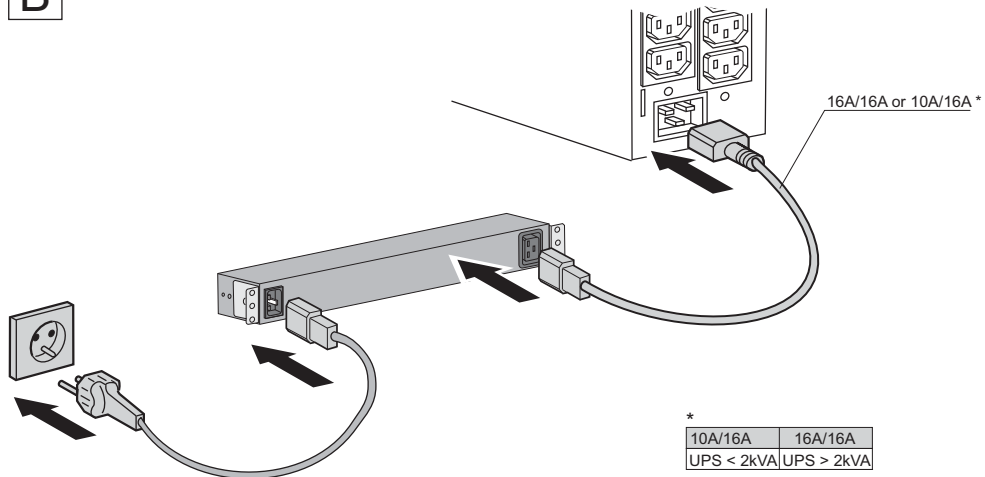

Important safety instruction:

Dangerous voltage levels are present within the filter. It should be opened exclusively by qualified service personnel.

Technical specifications

	Marine Filter 3000 VA
Power rating	3000 VA (Can be used with UPS up to 3 kVA)
Voltage	Single phase 220-240 V
Alternative current	16A max
Frequency	50/60 Hz
Inrush current	288A crest/68 μs
Dimensions (HxLxD)	86 mm x 440 mm (19") x 120 mm
Standards	
Safety standards	CEI 60950, CEI/EN 62040-1-1 & CEI 60945
EMC standards	CEI 62040-2 & CEI 60945
Environment	
▶ Operating temperature range	5°C to 55°C
▶ Relative humidity	20% to 90% (non-condensing)

