

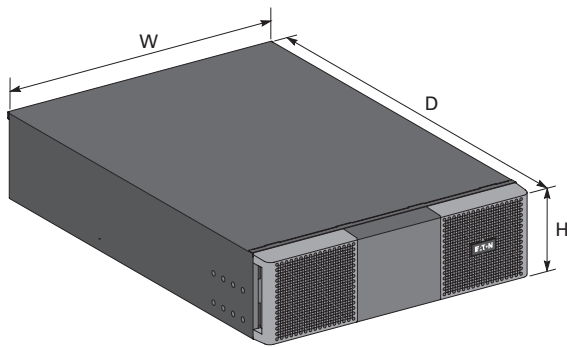

ИБП Eaton 9SX 8000i RT6U (9SX8KiRT) - Eaton Transformer 11000i - Инструкция по установке трансформатора

Постоянная ссылка на страницу: <https://eaton-power.ru/catalog/eaton-9sx/eaton-9sx-8000i-rt6u/>

Eaton® Transformer 11000i Installation Manual/Manuel d'installation



Description	Weight / Poids (lb/kg)	Dimensions (inch/mm) D x W x H
Eaton Transformer 11000i	185 / 84	27.5 x 17.3 x 5.1 / 700 x 440 x 130

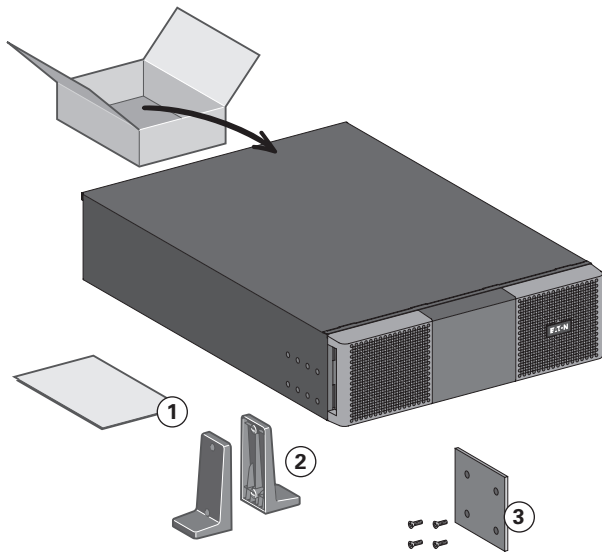

- ① Installation manual
Manuel d'installation
- ② (2) Tower stands
(2) Pieds de maintien
- ③ Stabilizer bracket (4 screws included)
Stabilisateur (4 vis fournies)

Eaton® Transformer 11000i Installation Manual/Manuel d'installation

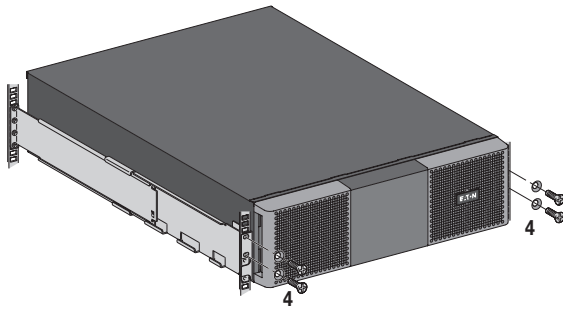
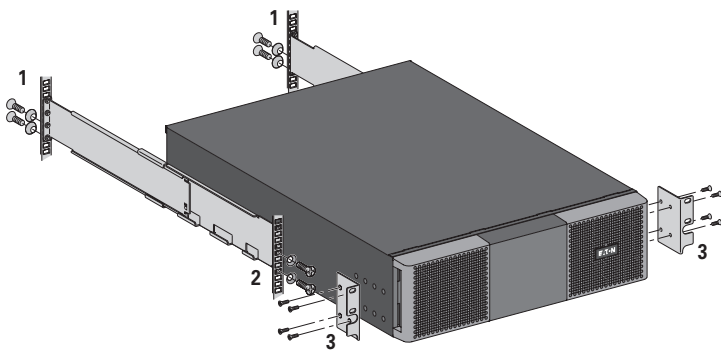
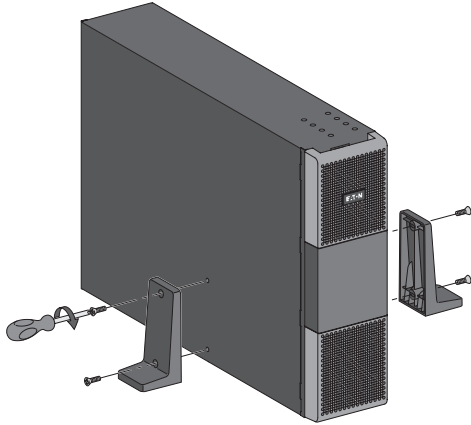

Eaton® Transformer 11000i Installation Manual/Manuel d'installation

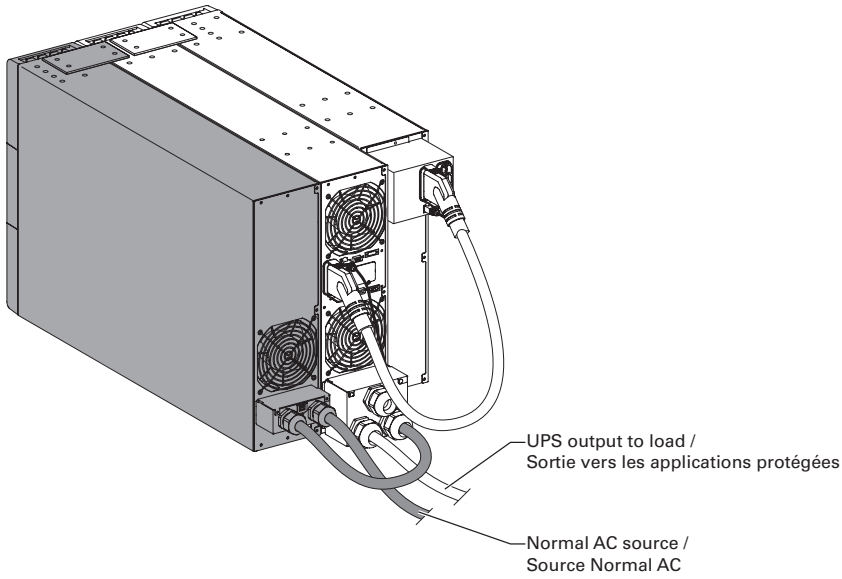

Nominal power / Puissance nominale	11000VA (220V, 230V, 240V) 10000VA (200V, 208V, 250V)
Max output current / Courant de sortie max	50A
Voltage range / Plage de tension	220V-276V at full load / à pleine charge
Frequency / Fréquence	46-65Hz ± 3Hz
Operating temperature / Température de fonctionnement	0°C-40°C
Relative humidity / Humidité relative	0-95% no condensing / sans condensation
Altitude derating / Déclassement < 3000m	10% per 1000m / 10% par tranche de 1000m
Isolation (IEC 61558-2-4)	3.75kV 5MOhms

Eaton® Transformer 11000i Installation Manual/Manuel d'installation

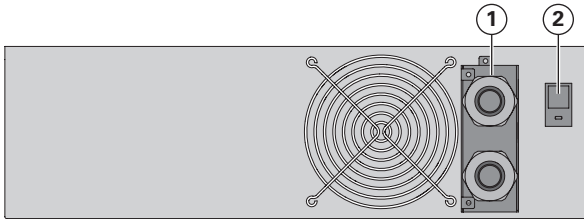

- ① Input/Output terminal blocks
Borniers d'entrée/sortie
- ② Output thermal switch
Disjoncteur thermique de sortie

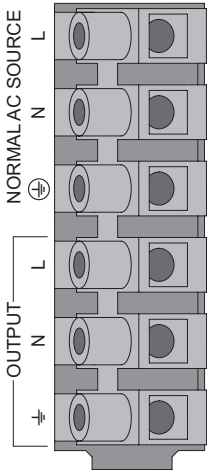

Recommended upstream protection / Protection amont recommandée

2 poles circuit breaker D curve - 63A
Disjoncteur 2 pôles courbe D - 63A

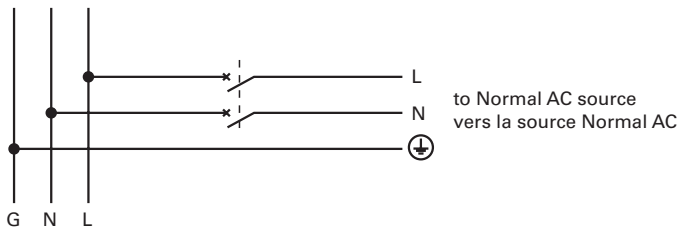

Recommended cable cross-sections / Sections de câble recommandées

Terminal Borne	Function Fonction	Terminal wire size rating Tailles de fil du bornier	Minimum wire size Taille minimum de fil	Tightening torque Couple de serrage
L	Phase	4-25 mm ² (12-4 AWG)	10 mm ² (8 AWG) 105°C	18 lb in / 2.03 Nm
N	Neutral Neutre		16 mm ² (6 AWG) 90°C	
⊕	Ground Terre			

Copper wire, solid or stranded / Fil de cuivre, plein ou tressé.