



ИБП Eaton 9SX 11000i RT6U (9SX11KiRT) - Eaton Supercharger 240 VDC - Особенности и порядок ус

Постоянная ссылка на страницу: <https://eaton-power.ru/catalog/eaton-9sx/eaton-9sx-11000i-rt6u/>

# Eaton® Supercharger 240VDC Installation Manual/Manuel d'installation

For use with UPS models / Pour utilisation avec les modèles d'ASI : 9SX8KiPM, 9SX11KiPM, 9PX8KPM, 9PX11KPM, 9PX8KiPM, 9PX11KiPM, 9PX6KiPM31, 9PX8KiPM31, 9PX11KiPM31.  
Operating temperature / Température de fonctionnement : 0°C-40°C.

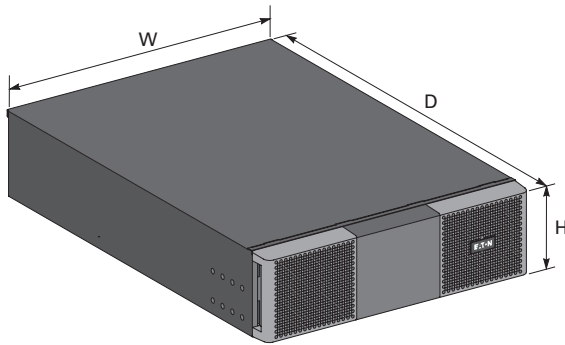

Description	Weight / Poids (lb/kg)	Dimensions (inch/mm) D x W x H
Eaton Supercharger 240VDC	33 / 15	27.5 x 17.3 x 5.1 / 700 x 440 x 130

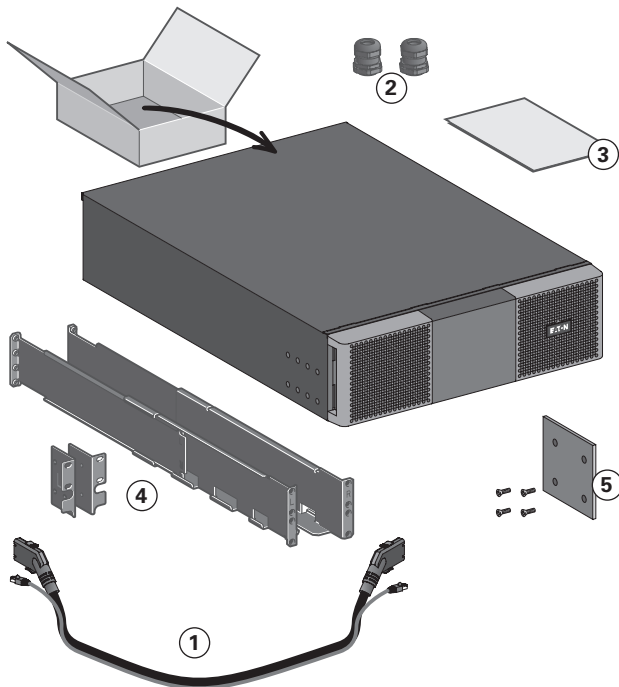

- ① Battery power cable, attached with battery detection cable  
Câble d'alimentation par batterie, joint au câble de détection de batterie
- ② (2) Cable glands for Input/Output connection  
(2) Presse-étoupes pour connexions d'E/S
- ③ Installation manual  
Manuel d'installation
- ④ Rack kit for 19-inch enclosures  
Kit de montage pour rack 19 pouces
- ⑤ Stabilizer bracket (4 screws included)  
Stabilisateur (4 vis fournies)

# Eaton® Supercharger 240VDC Installation Manual/Manuel d'installation

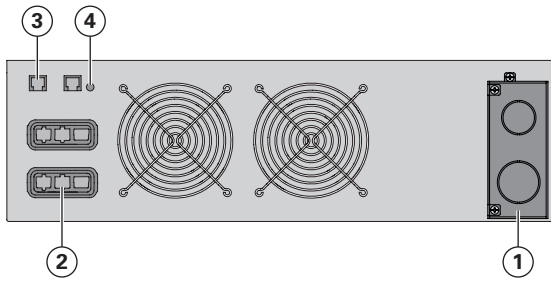

- ① Input AC/Output DC terminal blocks  
Borniers d'entrée AC/sortie DC
- ② Connector for battery modules (to the UPS and to the battery modules)  
Connecteurs pour modules batteries (vers l'UPS et vers les modules batteries)
- ③ Connector for automatic recognition of the Supercharger (to the UPS and to the battery modules)  
Connecteurs de reconnaissance automatique du Supercharger (vers l'UPS et vers les modules batteries)
- ④ LED On: when charging only / uniquement pendant la recharge

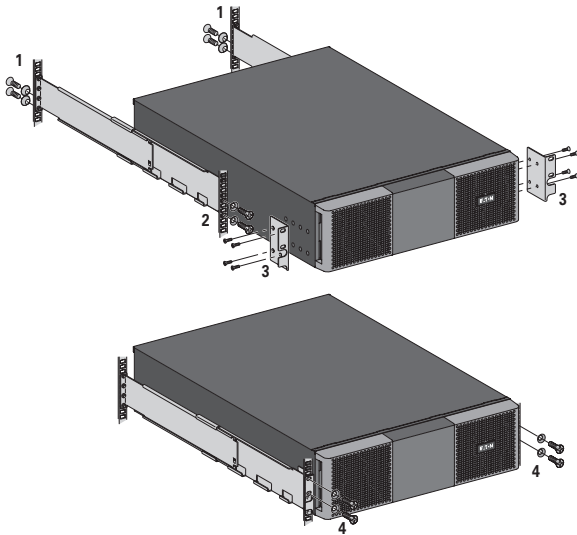
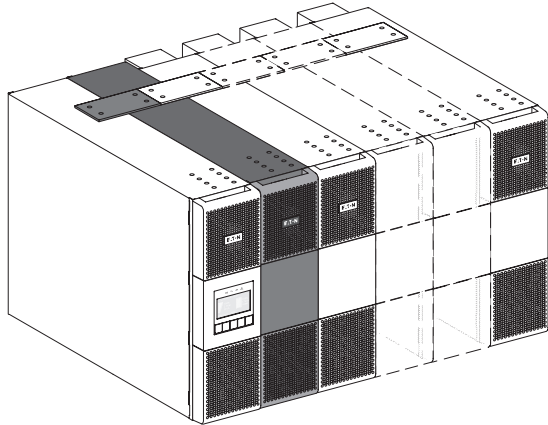

# Eaton® Supercharger 240VDC Installation Manual/Manuel d'installation

Automatic recognition of the Supercharger / Reconnaissance automatique du Supercharger :

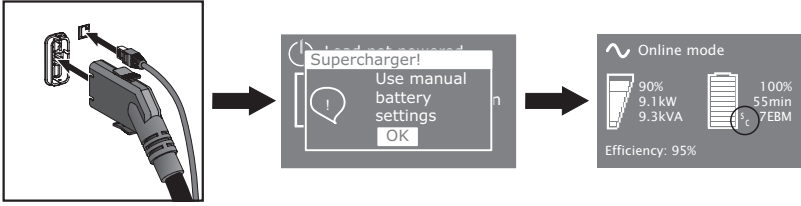

Plug the RJ45 / Brancher le RJ45

## EBM configuration (6-12 EBM 240 VDC)

 Set EBM manually: Battery settings → External battery → Manual EBM set.  
Régler manuellement les EBM : Réglages batterie → Batterie externe → Réglage EBM manuel.

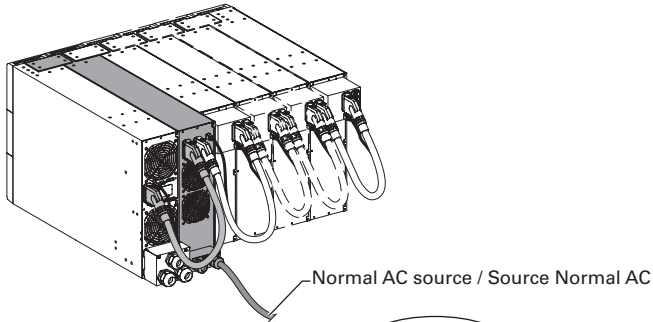

OR / OU

## External battery / Batterie externe configuration (50Ah – 400Ah / 240VDC)

 Set Ah manually: Battery settings → External battery → Manual battery set.  
Régler les Ah manuellement : Réglages batterie → Batterie externe → Réglage Ah manuel.

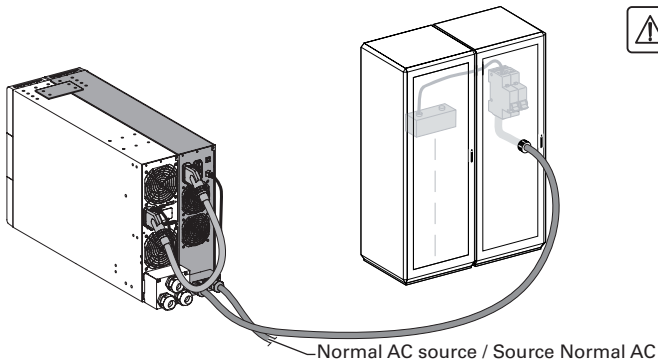

 Refer to the battery manufacturer's instructions regarding specific battery precautions.

Consultez les instructions du fournisseur de batterie concernant les précautions spécifiques à la batterie.

# Eaton® Supercharger 240 VDC Installation Manual/Manuel d'installation

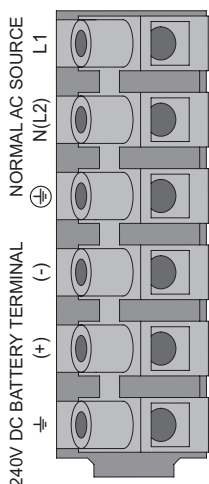

## Recommended upstream protection / Protection amont recommandée

2 poles circuit breaker D curve - 20A  
Disjoncteur 2 pôles courbe D - 20A

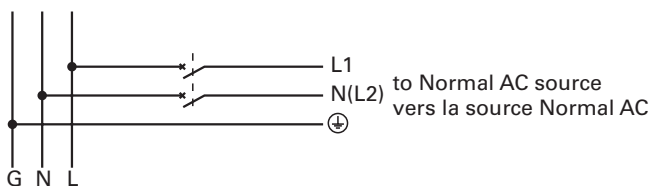

US installations only: to reduce the risk of fire, connect only to a circuit provided with 20A maximum branch circuit overcurrent protection in accordance with the National Electrical Code, ANSI/NFPA 70.

## Recommended battery protection / Protection batterie recommandée

2 poles circuit breaker - 300V - 60A  
Disjoncteur 2 pôles - 300V - 60A

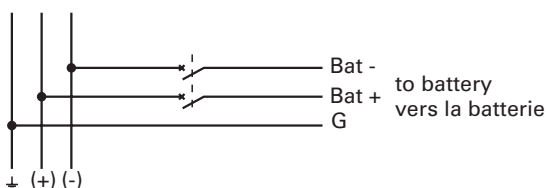

US installations only: to reduce the risk of fire, connect only to a circuit provided with 60A maximum branch circuit overcurrent protection in accordance with the National Electrical Code, ANSI/NFPA 70.



Disconnection and overcurrent protection devices shall be provided by others for permanently connected AC input and DC output circuits.

Les dispositifs de déconnexion et de protection contre les surintensités doivent être fournis par les tiers pour les circuits d'entrée en régime alternatif et de sortie en régime continu qui sont branchés en permanence.

## Recommended cable cross-sections / Sections de câble recommandées

Terminal Borne			Function Fonction	Terminal wire size rating Tailles de fil du bornier	Minimum wire size Taille minimum de fil	Tightening torque Couple de serrage
L1	N(L2)	⊕	Input AC	0.5-6 mm <sup>2</sup> (20-10 AWG)	4 mm <sup>2</sup> (12 AWG) 75°C	10 lb in / 1.13 Nm
⊕	(+)	(-)	Output DC	2.5-16 mm <sup>2</sup> (14-6 AWG)	16 mm <sup>2</sup> (6 AWG) 90°C	10 lb in / 1.13 Nm

Copper wire, solid or stranded / Fil de cuivre, plein ou tressé.