



ИБП Powerware 9340 - Eaton Powerware 9340 80 кВА - 130 кВА - Брошюра

Постоянная ссылка на страницу: <https://eaton-power.ru/catalog/powerware-9340/>

A woman with dark hair and glasses, wearing a purple sweater, is focused on working on a black Powerware 9340 UPS. She is holding a small white device connected to the UPS. The background shows a server room with wooden cabinets and various equipment.

**Powerware 9340**  
**80 kVA - 130 kVA**

**POWERWARE**<sup>®</sup>  
POWERING THE WORLD

# Paralleled for unparalleled reliability

Invensys Powerware, Europe's number one UPS manufacturer in the mid-range (5-75 kVA) category\*, is now introducing a global benchmark product in the high-end category. The new three-phase Powerware 9340 assumes the lead in UPS reliability and flexibility, taking you another step towards 100-percent power protection. The 9340 covers the power range 80-130 kVA and can be paralleled for both redundancy and capacity using Powerware's patented Hot Sync® technology.

\*Frost & Sullivan: World UPS market (November 2001)

## When 99.9% availability is not enough

As business is becoming increasingly global, many companies are integrating their IT in Enterprise Resource Planning (ERP) systems for maximum transparency and 24/7 service. The downside of this development is that uptime at workstation or server level is no longer enough—the entire system has to be available all the time.

Even 99.9% uptime results in 9 hours of downtime annually, which for many applications and companies is totally unacceptable. For example, the microprocessor manufacturer Intel would incur a calculated 20-million-dollar profit loss in a year, and 3,700 emergency calls would be left unanswered in the Los Angeles metro area alone. Powerware has nearly 40 years' experience in providing maximum uptime. Thousands of installed units in demanding aerospace, banking and IT systems are living proof of our success. The Powerware 9340 gives you maximum flexibility, reliability and system availability for your

entire enterprise, whether in a single building or spread around the world. It offers you a power solution that lets you stop worrying about power.

## No compromises

The 9340 is at home in any operating environment. Its robust design is capable of withstanding almost any operating and mains conditions. Thanks to its new, innovative rectifier, it provides no-compromise protection of the load while at the same time keeping the feeding mains network free of disturbances. More than that, its design incorporates well thought-through solutions geared to keep its total life-cycle cost at the lowest possible level.



### INFORMATION TECHNOLOGY SOLUTIONS

- Data centres
- Server farms
- Communications
- Broadcasting

### CRITICAL ELECTRICAL ENGINEERING

- Industrial controls
- Manufacturing machinery
- Process equipment

# Best available hardware, tested software and world-class service

If your business or application is dependent on a continuous power supply for its survival, you should look at the Powerware 9340. It will provide you with the most reliable power protection today, with room for expansion tomorrow.

The Powerware 9340 features **inherent reliability**. Only the most reliable hardware and technologies are used in its manufacture.

Thanks to its totally new advanced rectifier technology, it gives you the best in **Harmonic Control™**. Through a low harmonics content without any additional filtering, the 9340 is extremely mains and generator friendly.

Reliability is increased by advanced battery management functions such as **ABM™** (Advanced Battery Management) automatic discharge testing and temperature compensated charging voltage. Together, they can increase your battery lifetime up to 50% and will make sure your batteries are always in top shape!

Because the 9340 comes bundled with the **Software Suite**, you have total control over the system. The software package includes everything needed for trouble-free operation: LanSafe for orderly shutdown and PowerVision for monitoring.



## Powerware 9340 80-130 kVA

Feature	Benefit
Double conversion topology.	Trouble free output. Solution for every application.
Harmonic Control™	Active control leading to low current distortion in the input. Network friendly and optimised generator sizing.
Input power factor >0.99	Small input fuses, cheaper installation.
Build-in hardware redundancy	Distributed canbus control architecture, redundant 2+1 main cooling fans, redundant power supplies.
Hot Sync®	Patented paralleling technology requires no communication between modules, eliminating a system-level single-point-of-failure.
Advanced Battery Management (ABM)™	Reduced battery corrosion is resulting up to 50% longer battery lifetime.
Self-diagnostics	No unexpected failures. Digital DSP technology constantly monitors internal UPS operation.
Only front access needed for installation and service.	Easy access for service. Requires less space.

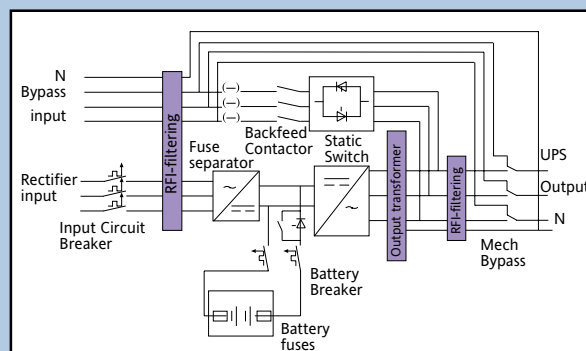

# Functionality that keeps your business running

## Inherent reliability

The 9340 has high internal fault tolerance. Its components are selected and sized for the worst possible conditions. It is designed with built-in redundancy at the critical points, such as fans, auxiliary power supplies and processors. It has distributed control architecture with independent circuit boards—there will always be a circuit board protecting the load, whatever happens. The internal CAN bus communications solution is robust and reliable. The status of the most critical components is constantly monitored and change times indicated. This allows for predictive maintenance and avoids unexpected breakdowns.

## Harmonic Control™

The 9340's advanced IGBT rectifier technology reduces harmonic content to 3%. In addition to more reliable system operation, this also leads to more economic generator sizing as losses in the generator windings are minimised. The benefit: while the input power factor is practically unity, the maintenance, cabling and fusing costs are simultaneously minimised. Because no additional filters are needed, the 9340 saves installation space and cost.

Active IGBT rectifier draws sinusoidal current irrespective of load and supply conditions

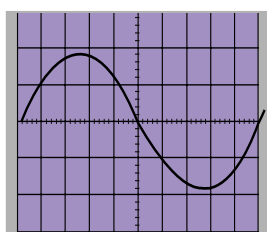

Typical input current with traditional thyristor rectifier

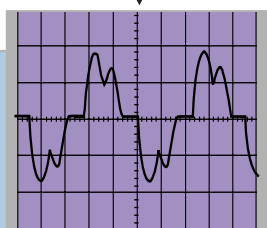

## ABM™

ABM constantly monitors battery charge status and only recharges when necessary. Compared with the traditional trickle-charging method, this reduces battery corrosion enough to provide 50% longer battery lifetimes! ABM system compensates for changes in ambient for proper charging, which leads to lower overall operation temperature.

Battery monitoring provides real-time information on battery string health and remaining runtime. This allows you to proactively plan maintenance operations instead of reacting to emerging problems. PW9340 tests the batteries regularly with the rectifier connected, thus providing consistent test results regardless of inverter load at testing time. Moreover, as the load is never supported by the battery alone, the 9340 will keep your critical load adequately protected at all times.

PW9340 IGBT model with Harmonic Control™



## Hot Sync®

Powerware's Hot Sync parallels two or more UPS units. Units are capable of load sharing without the need for communications wiring, hitherto the most vulnerable point of failure in all UPS systems. Each Powerware module has the ability to synchronise and support the critical load independently of the other modules. Thus all critical loads are supported by UPS-grade power, whatever maintenance needs—scheduled or unscheduled—should arise.

**Hot Sync—Redundant** is a two-module system allowing full maintenance to be performed on both modules and the parallel cabinet without the need for an external maintenance bypass and without having to remove the critical load from conditioned power.

**Hot Sync—Capacity** can accommodate up to four modules in parallel for the most critical applications. Superior monitoring and highly automated controls make this system as easy to operate as a single-module system.

## Easy installation

The Powerware 9340 can be installed with its back to the wall. Cooling air is expelled through the top. Top and bottom cable entry allows for side-by-side installation with other equipment. The inside of the cabinet is spacious for easy installation work. Yet, the 9340 expertly combines a small footprint with a very good efficiency ratio.

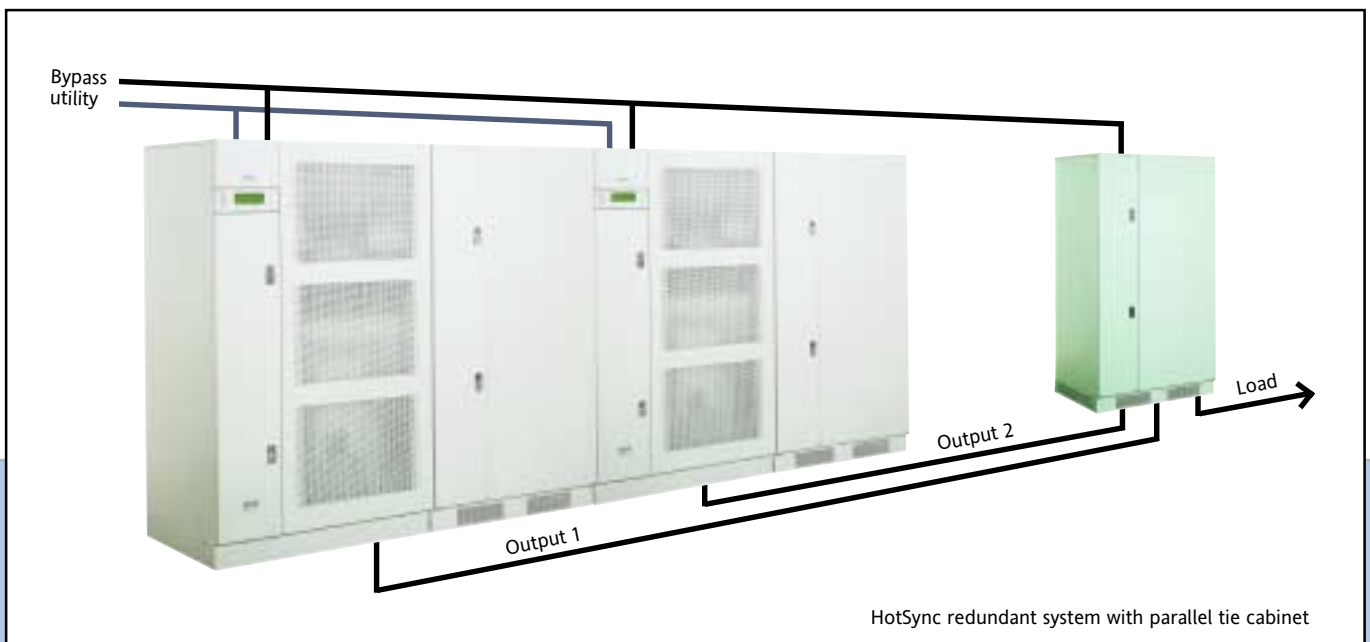
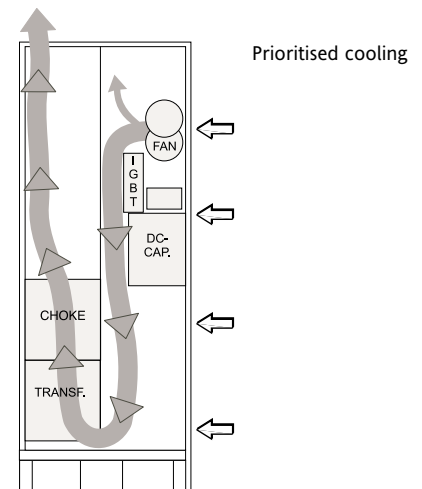

## Communication

Four X-Slot expansion bays and a comprehensive range of hot swappable connectivity option cards are provided for easy connectivity. One RS-232 port comes as standard, with more available on X-Slot expansion cards. The new modem card can therefore be used for remote monitoring service that provides maximum reliability and availability.

The ConnectUPS SNMP adapter provides network connectivity and interfacing with management systems such as HP OpenView, IBM NetView, CA Unicenter and Tivoli, as well as Powerware's monitoring and performance analysis software PowerVision.

Relay inputs and outputs can be used to provide an interface to building management systems and environmental monitoring.



The PW9340 features excellent connectivity capabilities:

- SNMP/Web communication card
- RS232 communication card
- Modbus/Jbus communication card
- AS/400 relay interface card
- Integral modem card (photo)



# Batteries for all occasions

You can choose from among a full line of battery cabinets for the 9340.

They provide a high degree of flexibility by accommodating a wide range of battery sizes optimised to meet the runtime requirements of your application. Up to four cabinets can be daisy-chained together for extended runtimes.

Internal configurations that line up and match are standard for the Powerware 9340. You can choose between local or remote configuration.

Additionally, a series of open rack based battery solutions are available. They offer a cost-effective alternative to battery cabinets and can be used when extended backup times are required.

## Easy installation and service

All Powerware battery cabinets feature top, bottom and side cable entry for the easiest possible installation. Front access greatly facilitates both installation and maintenance. In addition, the batteries are modularly packaged on sliding shelves, which makes periodic servicing easy.

Battery fuses in each cabinet provide protection and servicing isolation. Fully insulated battery cables provide additional safety.

## Highest reliability

Only the best available batteries are used for Powerware UPS systems. Standard solutions are based on high-performance batteries from the world's leading suppliers.

Built-in temperature measurement ensures that any unexpected problems within the cabinets are promptly detected and reported.

Powerware is an ISO 9001 certified manufacturer. The certification requires us to demand similar quality from all of our suppliers, too. That is why you can be assured that whatever the individual components in your specific system are, they represent the highest quality for the purpose—and that Powerware takes full responsibility for their functionality.

UPS with battery cabinet



Sliding shelves for easy maintenance





# 80-130 kVA POWERWARE 9340 IGBT

- IGBT inverter
- IGBT rectifier

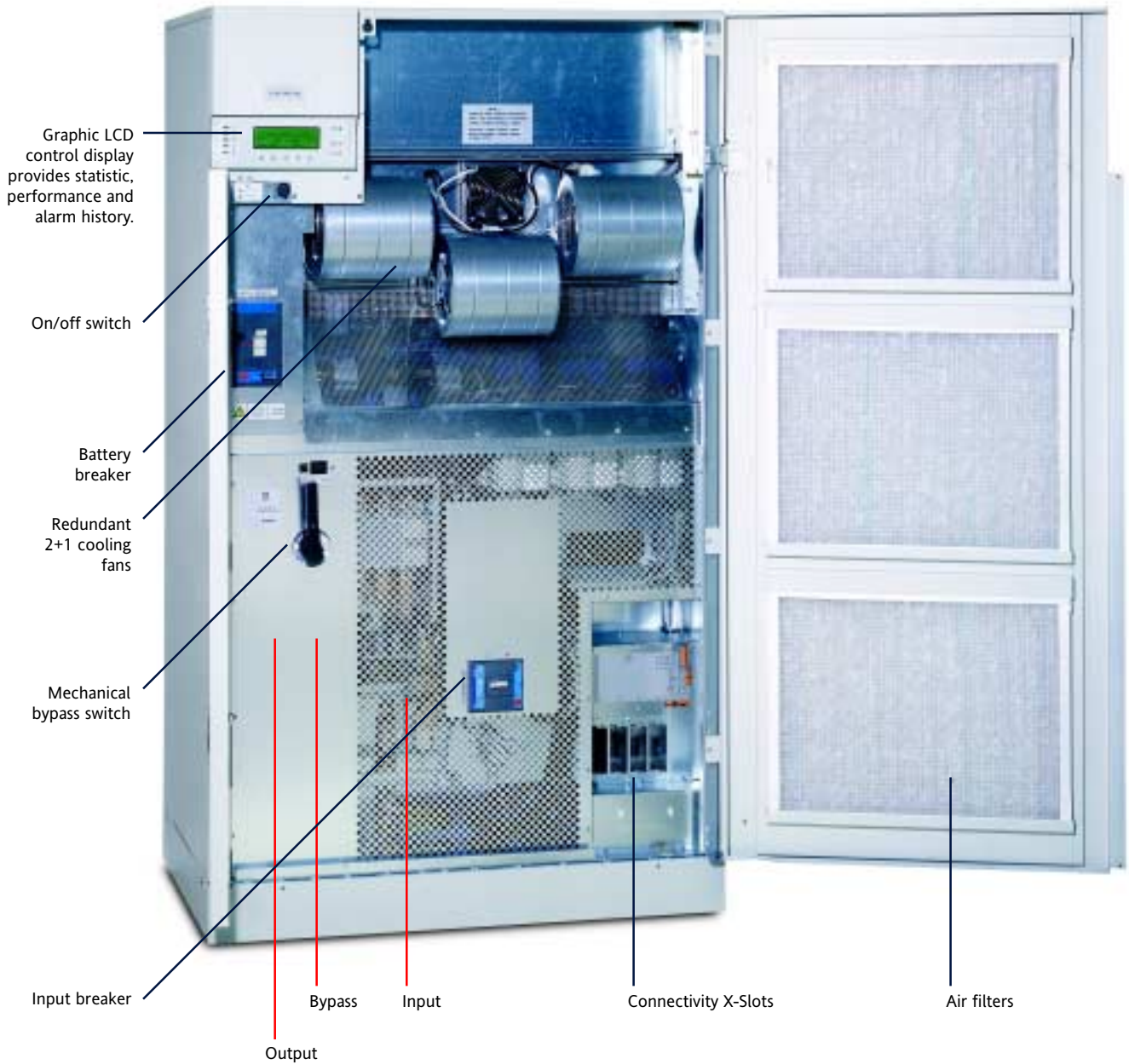

# 80-130 kVA POWERWARE 9340 SCR(F)

- IGBT inverter
- SCR rectifier

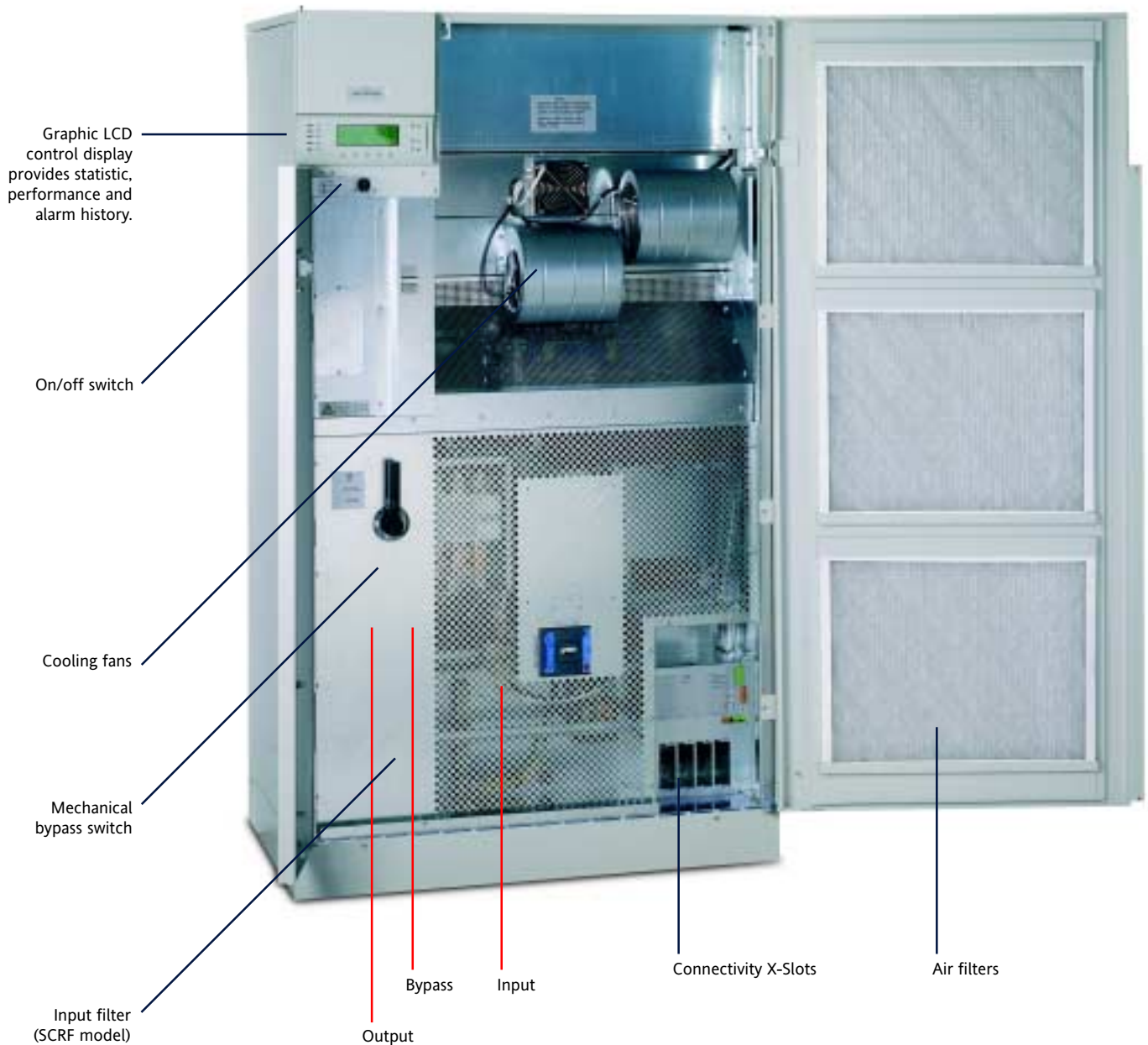

# Powerware 9340 Technical Data

Type	PW9430 - 80	PW9430 - 100	PW9430 - 130
Power rating	80 kVA / 64 kW	100 kVA / 80 kW	130 kVA / 104 kW
Topology	Double conversion on-line		
<b>Input</b>			
Input voltage range	342 – 456 V		
Input frequency range	45 –65 Hz		
Rated input current IGBT/SCRF/SCR	3 x 98/120/147 A	3 x 81/123/153 A	3 x 160/200/230 A
Maximum input current	3 x 154 A	3 x 192 A	3 x 250 A
Input current distortion THD	3% (IGBT)		
Input power factor	0.999 (IGBT)		
<b>Output</b>			
Output voltage	380 / 400 / 415 VAC selectable		
Output current	3 x 116 A	3 x 145 A	3 x 188 A
Rated output frequency	50 or 60 Hz selectable		
Output frequency variation	± 0,05 Hz free running, ± 3 Hz, synchronized to input with slew rate of changes < 1 Hz/second		
Steady-state performance	± 1%		
Dynamic response at 100% load step	± 5%, less than 1 millisecond to steady state		
Output voltage distortion	<3% THD linear load <5% THD non-linear load		
Overload capability	110% for 10 min; 125% for 1 min 150% for 30 sec 170% for 5 sec 1000% for 20 ms (bypass)		
Short circuit capability	520 A phase to neutral 15 cycles 300 A phase to phase 15 cycles		
Output power factor	0.7 lagging to 0.9 leading, crest factor full load 3:1		
Bypass	Integral static bypass and maintenance bypass		
<b>Total Efficiency</b>			
Normal mode	92%		
<b>Batteries</b>			
Back-up times	5 to 45 min, extendable to several hours		
Battery types	Valve regulated lead acid, 32 pcs 12V blocks with 10 years design		
Charging/discharging	ABM intermittent charging with Temperature Compensation, automatic discharge testing		
Operation	Optimum between +15°C and +25°C		
<b>Environmental</b>			
Storage temperature	-25°C to +60°C		
Operating temperature	0°C – +40°C ( max.+50°C)		
Operating altitude	Max. 1000m without derating		
Operating relative humidity	5 to 95%		
Audible noise at 1m	65-67 dB(A), ISO 7779		
Protection class	IP 20 and RAL 7035 colour		
<b>Dimensions</b>			
Dimensions ( W x D x H)	1100 x 766 x 1917 mm		
Weight	1040 kg (IGBT), 1030 kg (SCRF), 990 kg (SCR)		
<b>Standards</b>			
Safety	IEC 62040-1-1, EN50091-1-1, IEC 60950		
EMC	IEC 62040-2, EN 50091-2		
Quality	ISO 9001		
Markings	CE, GOST, FI		

# Dimensions

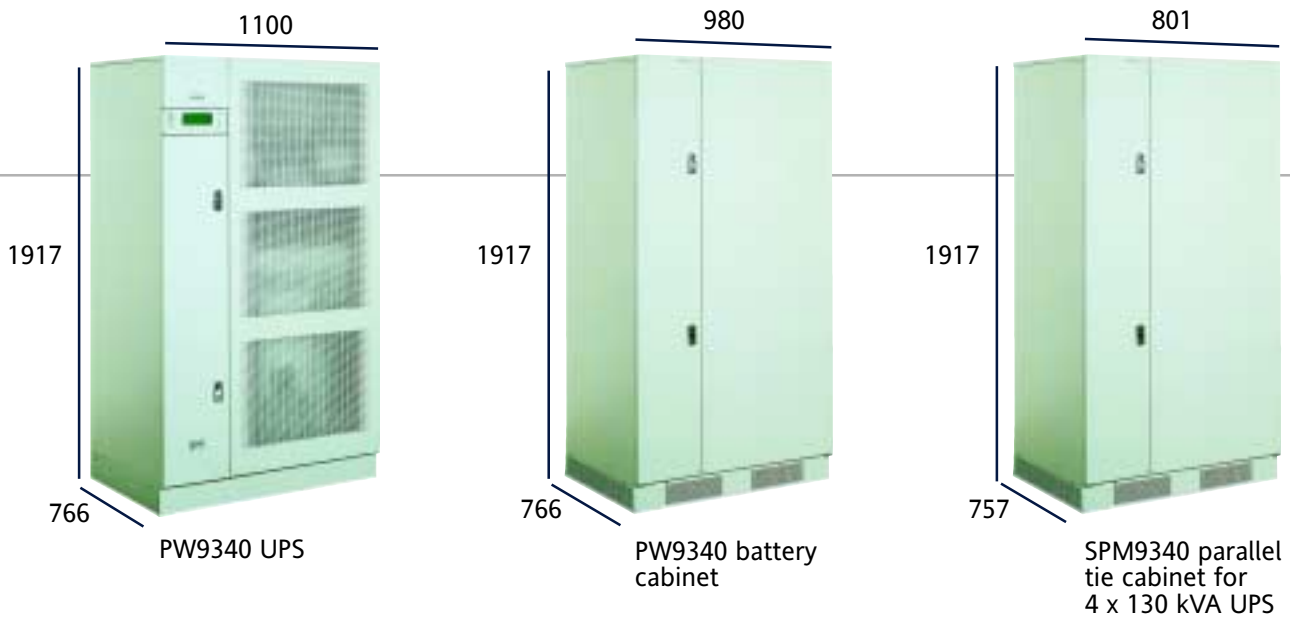

# Accessories IGBT/SCR(F)

IGBT 1040 kg  
SCR(F) 1030 kg  
SCR 990 kg

Battery rack

Battery cabinet  
HR 250 1050 kg  
HR 305 1200 kg  
HR 350 1350 kg  
CD 475 1800 kg

Remote ViewUPS display panel (multilingual)

X-Slots  
- SNMP/Web communication  
- RS232 interface  
- Modbus/Jbus communication  
- Relay interface (AS/400)  
- Integral modem

Hot Sync

Specials  
- Bypass isolation transformers  
- IP22 enclosure update  
- Marine versions and certificates  
- Special colours

Parallel tie cabinet  
- SPM9340-130-4 310 kg  
- SPM9305-130-2 (4Q 2002)

## Powerware at your service:

www.emea.powerware.com

### EUROPE/MIDDLE EAST/ AFRICA LOCATIONS

#### DENMARK

Hammerholmen 39 L-M  
DK-2650 Hvidovre  
Tel. +45-3677 7910  
Fax +45-3677 7921

#### FINLAND

Koskelontie 13  
FIN-02920 Espoo  
Tel. +358-9-452 661  
Fax +358-9-452 665 68

#### FRANCE

ZAC des Delâches  
BP 77  
GOMETZ-LE-CHATEL  
F-91940 Les Ulis  
Tel. +33-1-60 12 74 00  
Fax +33-1-60 12 74 01

#### GERMANY

Karl-Bold-Strasse 40  
D-77855 Achern  
Tel. +49-7841-6660  
Fax +49-7841-5000

Am Weichselgarten 30 a  
D-91058 Erlangen  
Tel. +49-9131-77 70 240  
Fax +49-9131-77 70 222

#### ITALY

Via Pellizza da Volpedo, 53  
I-20092 Cinisello Balsamo  
Milano  
Tel. +39-02-66 04 05 40  
Fax +39-02-66 04 06 50

#### NORWAY

Konowsgate 5  
N-0192 Oslo  
Tel. +47-23-03 65 50  
Fax +47-23-03 65 55

#### SWEDEN

Sågvägen 2  
PO Box 543  
S-184 25 Åkersberga  
Tel. +46-8-598 940 00  
Fax +46-8-598 940 40

#### UNITED KINGDOM

221 Dover Road  
Slough SL1 4RS  
Berkshire  
Tel. +44-1753-608 700  
Fax +44-1753-608 995

### WORLDWIDE LOCATIONS

#### WORLD HEADQUARTERS

8609 Six Forks Road  
Raleigh, NC 27615  
Tel. +1-919-872 3020  
Fax +1-919-870 3450

#### LATIN AMERICA

##### ARGENTINA

Belgrano 768  
5th PISO  
Buenos Aires 1092  
Tel. +54-1-331 0168  
Fax +54-1-334 0104

##### BRAZIL

Rua Estella Borges Morato  
336  
Barro De Limao  
Sao Paulo 02722-000  
Tel. +55-11-855 8555  
Fax +55-11-855 8530

#### ASIA PACIFIC

##### AUSTRALIA

119-127 Wicks Road  
North Ryde  
Sydney 2113 NSW  
Tel. +61-2-9878 5000  
Fax +61-2-9878 5555

##### CHINA

Room 2718, 27/F, South  
Tower, Kerry Centre  
No 1 Guanfhua Lu  
Chaoyang District  
Beijing 100020  
Tel. +86-10-852 99 889  
Fax +86-10-852 99 879

##### HONG KONG

Room 1811, 18/F, Kodak  
House II  
38-39 Healthy Street East  
North Point  
Tel. +852-2830 3003  
Fax +852-2745 6177

##### INDIA

4, Community Centre  
Panchsheel Park  
New Delhi 110017  
Tel. +91-11-6499421  
Fax +91-11-6499420

#### JAPAN

1-11-15 Higashi-Gotanda  
Shinagawa  
Tokyo 141-0022  
Tel. +81-3-3447 5251  
Fax +81-3-3447 5252

#### SINGAPORE

62 Toh Guan Road  
#05-00 Freight Links Express  
Distripark  
608831 Singapore  
Tel. +65-895 8330

#### NEW ZEALAND

14 The Boulevard  
Sunnyhills-Pakuranga  
Auckland 1706  
Tel. +64-9-576 6842  
Fax +64-9-576 6843

#### USA

2727 Kurtz Street  
San Diego, CA 92110  
Tel. +1-619-291 4211  
Fax +1-619-291 2973

