



ИБП Eaton 9355М 8 kVA - ИПБ Eaton морского исполнения - Каталог

Постоянная ссылка на страницу: <https://eaton-power.ru/catalog/eaton-9355-marine/eaton-9355m-8-kva/>

Marine & offshore UPS

Power protection on board



EATON

Powering Business Worldwide

Power protection systems on board for safety and business

Our top priority is securing the continuity of your business. Eaton's state-of-the-art UPS hardware, experience, problem-solving capabilities and commitment to good customer and maintenance services have made us the market leader in marine and offshore UPS solutions.

We have extensive experience in supplying the marine industry with uninterruptible power systems. Eaton® integrates a full line of uninterruptible power systems, power conversion products, power management software, remote monitoring, turnkey integration services and site support. Eaton has direct sales and service presence in more than 150 countries around the world.

www.eaton.com/powerquality/marine



Powering marine and offshore applications

The increasing amount of new technology installed on board presents a whole new set of challenges to the electrical power supply of a vessel or a rig. Today's sophisticated high technology equipment can fail to do its work or even get damaged if the input power has disturbances or breaks down completely. That is why power systems that supply uninterruptible and clean power are essential on board. These systems are called Uninterruptible Power Systems or UPS systems.

The equipment that needs power protection can be roughly divided into:

- **Safety and cruising related systems**, such as navigation equipment and emergency lighting. Classification organisations normally require UPS protection for these systems.
- **Commercial applications**, such as casinos and EPOS devices at restaurants and shops. Customer satisfaction depends on the smooth operation of these systems.
- **Special systems on board special vessels**. Exploring, drilling, lifting, and cable laying, for example, is accurate and sensitive work where mistakes cannot be tolerated.
- **Business and management support**, such as computer systems that enable continuous business management.



Technology

Eaton is experienced in delivering solutions for the most demanding applications. As an example, marine UPSs have special dependability requirements due to harsh environmental conditions and to the critical nature of the protected equipment. Eaton has supplied marine UPSs to thousands of vessels over the years.

Eaton marine UPSs are designed to meet the most stringent industry standards. The double-conversion online topology (*picture 1*) with a static bypass switch is Eaton's choice for marine use. This protects against all types of power disturbances that may occur in the supplying network and is the only topology that meets the highest performance class, VFI-SS-111, requirements. All Eaton UPSs are tested and certified to meet appropriate safety and EMC standards.

Eaton UPSs are built into one cabinet that houses all the electronics: the rectifier, the inverter, the static bypass and the microprocessor control. This configuration allows the entire system to be controlled as one integral device. This leads to higher reliability than using separate power converters. It also saves plenty of valuable space.

Higher reliability

The most critical loads may require increased protection. Therefore all 3-phase systems can be connected to parallel redundant configuration (*picture 2*).

In such a system two or more UPSs are supplying and sharing the same load. Should a failure occur in any of the UPS units, the faulty unit is automatically disconnected from the load and the remaining unit or units continue to supply the load. This redundancy leads to extremely high system level reliability.

Communication options

System performance monitoring is often crucial for continuous operation. Therefore a versatile combination of remote communication options via serial communication ports and potential free contacts are available.

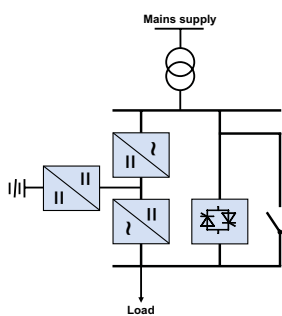

Picture 1.
Double-conversion online UPS topology

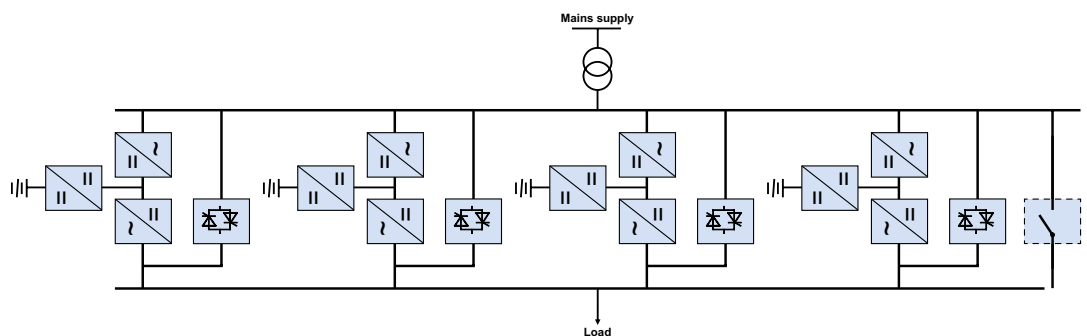

Picture 2.
Parallel redundant UPS system

Applications



- Satellite communication
- Ship automation
- Dynamic Positioning System
- Azipod control
- Internal cable TV
- Intercom, security camera systems
- Emergency Public Announcement
- Business and customer satisfaction
- Water-proof doors
- Power distribution, filtering
- Control/monitoring system
- Computer systems



Products

Eaton Marine UPS

Small systems 0-3 kVA

DNV and ABS type approved on-line double conversion UPS with automatic bypass, tower or Rack/Tower versatile, multilingual LCD display, hot swappable batteries, power management software, USB and Serial port.



9130 3 kVA



Mid range systems 8-160 kVA

DNV type approved, BV type approved and ABS design assessed up to 15kVA, double-conversion online technology with power ratings 8-10kVA, single-phase input and output, 8-30kVA, three-phase input and single-phase output and 8-160kVA three-phase input and output, small foot print, patented Hot Sync® parallel capability up to four redundant systems, ABM™ technology to extend battery service life, wide communication options.



EX 3 kVA



Large systems 225-1100 kVA

Double-conversion online technology with power ratings 225-1100 kVA, three-phase input and output, small foot print, possible for inherent redundancy, patented Hot Sync parallel capability up to four redundant systems, ABM technology to extend battery service life, wide communication options.



9155/9355-15 kVA



Customised solutions

Beyond standard product offering it is possible to do project based modifications to meet environment requirements and customer needs. Whether these modifications are related to physical functional and appearance requirements or there is need for special regulation requirements Eaton can find the optimal solution.



References

Eaton has the pleasure to work with top shipping companies and ship builders around the world. Our list of references includes UPS deliveries for a wide range of vessels from cruise liners and ferries to ice breakers and dredgers; from LNG carriers and cable ships to oil rigs. Contact our local sales office for references.

Approvals

- Eaton has type approvals for models up to 15 kVA
- Eaton is working for system testing and certification with:
 - Lloyd's Register of Shipping (LR)
 - American Bureau of Shipping (ABS)
 - Det Norske Veritas (DNV)
 - Germanischer Lloyd (GL)
 - Bureau Veritas (BV)
 - RINA
 - Korean standard (KR)
 - China Classification Society (CCS)
 - Russian Maritime Register of Shipping (RMRS)

Marine UPS Service

Eaton's UPS service network comprises more than 1200 service professionals and a number of authorised service partners worldwide. They make sure you get the same high quality services wherever you operate. We are available for our customers in all main ports around the world. Eaton offers service on every step of installation projects from detailed design to a full installation.



Eaton service products:

- Installation
- Commissioning and User's trainings
- Preventive maintenance
- Telephone support
- Battery analysis and replacement
- System upgrades
- Spare parts



Eaton is dedicated to ensuring that reliable, efficient and safe power is available when it's needed most. With unparalleled knowledge of electrical power management across industries, experts at Eaton deliver customised, integrated solutions to solve our customers' most critical challenges.

Our focus is on delivering the right solution for the application. But, decision makers demand more than just innovative products. They turn to Eaton for an unwavering commitment to personal support that makes customer success a top priority.

For more information, visit www.eaton.eu/electrical



Eaton Industries Manufacturing GmbH
Electrical Sector EMEA
Route de la Longeraie 7
1110 Morges, Switzerland
Eaton.eu

© 2015 Eaton Corporation
All Rights Reserved
Printed in Europe
Publication No. BR153054EN
August 2015

Changes to the products, to the information contained in this document, and to prices are reserved; so are errors and omissions. Only order confirmations and technical documentation by Eaton is binding. Photos and pictures also do not warrant a specific layout or functionality. Their use in whatever form is subject to prior approval by Eaton. The same applies to Trademarks (especially Eaton, Moeller, and Cutler-Hammer). The Terms and Conditions of Eaton apply, as referenced on Eaton internet pages and Eaton order confirmations.

Eaton is a registered trademark of Eaton Corporation. All other trademarks are property of their respective owners.

Follow us on social media to get the latest product and support information.

