



ИБП Eaton 5125 RM 6000VA - Внешние батарейные модули Eaton 240В - Пользовательское руково

Постоянная ссылка на страницу: <https://eaton-power.ru/catalog/powerware-5125-rm/5125-rm-6000va/>

Powerware Series

**Eaton® 240V Extended Battery Module
(EBM 240)
User's Guide**

For use with the Eaton 5125 or 9125 UPS (5000/6000 VA)



Special Symbols

The following are examples of symbols used on the UPS or accessories to alert you to important information:



RISK OF ELECTRIC SHOCK - Observe the warning associated with the risk of electric shock symbol.



CAUTION: REFER TO OPERATOR'S MANUAL - Refer to your operator's manual for additional information, such as important operating and maintenance instructions.



This symbol indicates that you should not discard the UPS or the UPS batteries in the trash. This product contains sealed, lead-acid batteries and must be disposed of properly. For more information, contact your local recycling/reuse or hazardous waste center.



This symbol indicates that you should not discard waste electrical or electronic equipment (WEEE) in the trash. For proper disposal, contact your local recycling/reuse or hazardous waste center.

Eaton and Powerware are registered trademarks of Eaton Corporation or its subsidiaries and affiliates.

©Copyright 2003–2010 Eaton Corporation, Raleigh, NC, USA. All rights reserved. No part of this document may be reproduced in any way without the express written approval of Eaton Corporation.

Table of Contents

1	Introduction	1
	Safety Warnings	2
2	Installation	15
	Inspecting the Equipment	15
	EBM Installation	15
	Eaton 9125 EBM Tower Setup	16
	EBM Connections	18
	Eaton 5125 EBM Configuration	20
3	EBM Maintenance	23
	UPS and Battery Care	23
	Storing the EBM	23
	When to Replace Batteries	23
	Replacing Batteries	24
	How to Replace Eaton 5125 EBM	24
	How to Replace Eaton 9125 EBM	26
	Recycling the Used Battery or UPS	28
4	Service and Support	29

Chapter 1 Introduction

The 240V Extended Battery Module (EBM 240) can be added to the 5000/6000 VA Eaton® 5125 or 9125 uninterruptible power system (UPS) to extend the available UPS battery time (see Table 1 or Table 2). Up to four EBMs can be installed with either UPS.

Table 1. Eaton 5125 Battery Runtimes (in Minutes)

5000 VA, 4500W Models					
Load	UPS Internal Batteries	+1 EBM	+2 EBMs	+3 EBMs	+4 EBMs
900W	59	169	303	452	612
1350W	39	108	192	284	384
1800W	26	79	138	204	274
2250W	19	61	106	156	210
2700W	15	49	85	125	168
3150W	12	41	71	104	139
3600W	9	31	60	88	118
4050W	8	27	52	76	102
4500W	7	24	46	67	89
6000 VA, 5400W Models					
Load	UPS Internal Batteries	+1 EBM	+2 EBMs	+3 EBMs	+4 EBMs
1080W	49	138	247	367	497
1620W	33	88	156	230	311
2160W	20	64	111	164	221
2700W	15	49	85	125	168
3240W	11	40	68	100	134
3780W	9	33	57	83	111
4320W	7	25	48	70	94
4860W	6	22	42	61	81
5400W	5	19	36	53	71

NOTE Battery times are approximate and vary depending on the load configuration and battery charge.

Table 2. Eaton 9125 Battery Runtimes (in Minutes)

Load	Internal UPS Batteries	+1 EBM	+2 EBMs	+3 EBMs	+4 EBMs
6000 VA/4200W	9.7	29.7	52.1	76.3	102
5000 VA/3500W	13.2	37.4	65.3	95.6	127.7
4000 VA/2800W	19.2	49.2	85.8	125.4	167.5
3000 VA/2100W	24.3	70.1	121.9	178.0	237.4
2000 VA/1400W	37.7	107.5	186.2	271.4	361.6

NOTE Battery times are approximate and vary depending on the load configuration and battery charge.

Safety Warnings

Read the following precautions before you install the EBM.

IMPORTANT SAFETY INSTRUCTIONS SAVE THESE INSTRUCTIONS

This manual contains important instructions that you should follow during installation and maintenance of the EBM. Please read all instructions before operating the equipment and save this manual for future reference.

WARNING



This UPS contains its own energy source (batteries). The UPS output receptacles may carry live voltage even when the UPS is not connected to an AC supply.

CAUTION



- Batteries can present a risk of electrical shock or burn from high short-circuit current. Observe proper precautions. Servicing should be performed by qualified service personnel knowledgeable of batteries and required precautions. Keep unauthorized personnel away from batteries.
- Proper disposal of batteries is required. Refer to your local codes for disposal requirements.
- Never dispose of batteries in a fire. Batteries may explode when exposed to flame.

Sikkerhedsanvisninger

VIGTIGE SIKKERHEDSANVISNINGER GEM DISSE ANVISNINGER

Denne manual indeholder vigtige instruktioner, som skal følges under installation og betjening af EBM-enheden. Læs venligst alle instruktioner inden betjening af udstyret og gem denne manual mhp. fremtidige opslag.

ADVARSEL!



Denne UPS indeholder sin egen energikilde (batterier). Udgangsstikkene kan endog være strømførende, når UPS'en ikke er koblet til en vekselstrømsforsyning.

ADVARSEL



- Batterierne kan give risiko for elektrisk stød eller brandsår forårsaget af høj kortslutningsstrøm. Overhold gældende forsigtighedsregler. Servicing skal udføres af kvalificeret servicepersonale med kendskab til batterier og gældende forsigtighedsregler. Hold uautoriseret personale væk fra batterierne.
 - Korrekt bortskaffelse af batterier er påkrævet. Overhold gældende lokale regler for bortskaffelsesprocedurer.
 - Skaf dig aldrig af med batterierne ved at brænde dem. Batterierne kan eksplodere ved åben ild.
-

Belangrijke Veiligheidsinstructies

BELANGRIJKE VEILIGHEIDSINSTRUCTIES BEWAAR DEZE INSTRUCTIES

Deze handleiding bevat belangrijke instructies die u dient te volgen tijdens de installatie en het gebruik van EBM. Lees alle instructies voordat u de apparatuur in bedrijf neemt en bewaar deze handleiding als naslagwerk.

WAARSCHUWING



Deze UPS bevat een eigen energiebron (batterijen). De uitgangcontactdoos kan onder spanning staan, zelfs wanneer de UPS niet is aangesloten op de netspanning.

OPGELET



- Batterijen leveren gevaar op voor elektrische schokken en kunnen brandwonden veroorzaken door een grote kortsluitstroom. Neem de juiste voorzorgsmaatregelen in acht. Het onderhoud moet worden uitgevoerd door bevoegde onderhoudsmonteurs die verstand hebben van accu's en op de hoogte zijn van de vereiste voorzorgsmaatregelen. Houd onbevoegden uit de buurt van de accu's.
 - De batterijen moeten op de juiste wijze worden opgeruimd. Raadpleeg hiervoor uw plaatselijke voorschriften.
 - Nooit batterijen in het vuur gooien. De batterijen kunnen ontploffen.
-

Tarkeita Turvaohjeita

TÄRKEITÄ TURVAOHJEITA - SUOMI SÄILYTÄ NÄMÄ OHJEET

Tämä käyttöohje sisältää tarkeitä ohjeita, joita on noudatettava EBM-yksikön asennuksen ja käytön yhteydessä. Lue kaikki ohjeet ennen laitteiston käyttöä ja säilytä ohje myöhempää tarvetta varten.



VAROITUS

Tässä UPS-virtalähteessä on oma energianlähde (akut). Lähtövastakkeissa voi olla jännite, vaikka UPS-virtalähdettä ei ole kytketty verkkovirtaan.



VARO

- Akut voivat aiheuttaa sähköiskun tai palovammojen vaaran johtuen suuresta oikosulkuvirrasta. Noudata kaikkia asianmukaisia varotoimia. Laitteen saa huoltaa vain ammattitaitoinen huoltohenkilökunta, joka tuntee akut ja niihin liittyvät varotoimet. Älä päästä valtuuttamatonta henkilöstöä lähelle akkuja.
- Akusto täytyy hävittää säädösten mukaisella tavalla. Noudata paikallisia määräyksiä.
- Älä koskaan heitä akkuja tuleen. Ne voivat räjähtää.

Consignes de Sécurité

CONSIGNES DE SÉCURITÉ IMPORTANTES CONSERVER CES INSTRUCTIONS

Ce manuel contient des instructions importantes que vous êtes invité à suivre lors de toute procédure d'installation et de fonctionnement de l'EBM. Veuillez consulter entièrement ces instructions avant de faire fonctionner l'équipement et conserver ce manuel afin de pouvoir vous y reporter ultérieurement.

AVERTISSEMENT!



Cette onduleur possède sa propre source d'alimentation (batteries). Il est possible que les prises de sortie soient sous tension même lorsque l'onduleur n'est pas connectée à une alimentation CA.

ATTENTION!



- Les batteries peuvent présenter un risque de choc électrique ou de brûlure provenant d'un courant de court-circuit haute intensité. Observez les précautions appropriées. L'entretien doit être réalisé par du personnel qualifié connaissant bien les batteries et les précautions nécessaires. N'autorisez aucun personnel non qualifié à manipuler les batteries.
 - Une mise au rebut réglementaire des batteries est obligatoire. Consulter les règlements en vigueur dans votre localité.
 - Ne jamais jeter les batteries au feu. L'exposition aux flammes risque de les faire exploser.
-

Sicherheitswarnungen

WICHTIGE SICHERHEITSANWEISUNGEN AUFBEWAREN

Dieses Handbuch enthält wichtige Hinweise, welche Sie bei der Installation und Wartung des EBM beachten sollten. Bitte lesen Sie alle Anweisungen des Handbuches bevor sie mit dem Gerät arbeiten. Bewahren Sie das Handbuch zum Nachlesen auf.

ACHTUNG



Dieses UPS (Unterbrechungsfreies Stromversorgungssystem - USV) enthält eine eigene Energiequelle (Batterien). Die Ausgangssteckdosen können Spannung führen, auch wenn das UPS (USV) nicht an eine Wechselstromquelle angeschlossen ist.

VORSICHT!



- Batterien können das Risiko eines elektrischen Schlags bergen oder durch hohen Kurzschlussstrom in Brand geraten. Die richtigen Vorsichtsmaßnahmen beachten. Die Wartung muss von qualifiziertem Wartungspersonal durchgeführt werden, das im Umgang mit Batterien geübt ist und über gute Kenntnisse der erforderlichen Vorsichtsmaßnahmen verfügt. Nicht autorisiertes Personal von Batterien fern halten.
 - Die Batterien müssen ordnungsgemäß entsorgt werden. Hierbei sind die örtlichen Bestimmungen zu beachten.
 - Batterien niemals verbrennen, da sie explodieren können.
-

Avvisi di Sicurezza

IMPORTANTI ISTRUZIONI DI SICUREZZA CONSERVARE QUESTE ISTRUZIONI

Il presente manuale contiene importanti istruzioni da seguire durante l'installazione e il funzionamento di EBM. Leggere integralmente le istruzioni prima di utilizzare l'apparecchiatura e conservare il presente manuale per futuro riferimento.

AVVERTENZA



L'UPS contiene la propria fonte di energia (batterie). Le prese d'uscita possono essere sotto tensione anche quando l'UPS non è collegato all'alimentazione elettrica CA.

ATTENZIONE



- Le batterie possono comportare un rischio di scossa elettrica o di ustione in seguito a un'elevata corrente di corto circuito. Osservare le dovute precauzioni. L'assistenza deve essere eseguita da personale qualificato esperto di batterie e delle necessarie precauzioni. Tenere il personale non autorizzato lontano dalle batterie.
 - Le batterie devono essere smaltite in modo corretto. Per i requisiti di smaltimento fare riferimento alle disposizioni locali.
 - Non gettare mai le batterie nel fuoco poichè potrebbero esplodere se esposte alle fiamme.
-

Viktig Sikkerhetsinformasjon

VIKTIGE SIKKERHETSINSTRUKSJONER GJEM DISSE INSTRUKSJONENE

Denne håndboken inneholder viktige instruksjoner som du bør overholde ved montering og bruk av EBM. Les alle instruksjoner før utstyret tas i bruk, og gjem håndboken til fremtidig referanse.

FARLIG



UPS-enheten inneholder sin egen energikilde (batterier). Utgangsstikkene kan være strømførende selv når UPS-enheten ikke er koblet til et strømuttak.

FORSIKTIG



- Batterier kan utgjøre en fare for elektrisk støt eller brannskade pga. høy kortslutningsstrøm. Treff passende forholdsregler. Service bør utføres av kvalifisert servicepersonale med kjennskap til batterier og nødvendige forholdsregler. Hold uautorisert personale borte fra batteriene.
 - Batterier må fjernes på korrekt måte. Se lokale forskrifter vedrørende krav om fjerning av batterier.
 - Kast aldri batterier i flammer, da de kan eksplodere, hvis de utsettes for åpen ild.
-

Regulamentos de Segurança

INSTRUÇÕES DE SEGURANÇA IMPORTANTES GUARDE ESTAS INSTRUÇÕES

Este manual contém instruções importantes que devem ser seguidas durante a instalação e operação da EBM (Produção de energia elétrica por indução magnética). Leia todas as instruções antes de operar o equipamento e guarde este manual para consultá-lo futuramente.

ADVERTÊNCIA



Este no-break possui sua própria fonte de energia (baterias). As tomadas de saída podem estar energizadas mesmo que o no-break não esteja conectado a uma fonte de energia elétrica.

PERIGO



- As baterias podem oferecer risco de choque elétrico ou queimadura, ocasionados por alta tensão com possibilidade de curto-circuito. Tome as precauções adequadas. A manutenção deve ser realizada por pessoal qualificado, com conhecimento sobre baterias e ciente das precauções exigidas. Mantenha o pessoal não autorizado afastado das baterias.
- Siga as instruções apropriadas ao desfazer-se das baterias. Consulte os códigos do local para maiores informações sobre os regulamentos de descarte de produtos.
- Nunca jogue as baterias no fogo, porque há risco de explosão.

Предупреждения по мерам безопасности

ВАЖНЫЕ УКАЗАНИЯ ПО МЕРАМ БЕЗОПАСНОСТИ СОХРАНИТЕ ЭТИ УКАЗАНИЯ

В данном руководстве содержатся важные инструкции по установке и обслуживанию внешнего батарейного модуля или устройства распределения электропитания. Перед работой с оборудованием прочтите все инструкции. Сохраните данное руководство для дальнейшего использования.

ПРЕДУПРЕЖДЕНИЕ



В данном ИБП установлены собственные источники энергии (батареи). На выходных розетках может быть напряжение, даже если ИБП не подключен к сети переменного тока.

ОСТОРОЖНО



- Высокое напряжение, вызванное коротким замыканием в батарее, может привести к поражению электрическим током или ожогу. Соблюдайте меры предосторожности. Техническое обслуживание должно осуществляться квалифицированным персоналом по работе с источниками питания, знакомым с мерами предосторожности. Не допускайте к работе с батареями посторонних.
- Необходимо соблюдать правила утилизации аккумуляторов. Обратитесь к местным нормативным актам за информацией о требованиях к утилизации.
- Никогда не бросайте аккумуляторы в огонь. Аккумуляторы могут взорваться под воздействием огня.

Advertencias de Seguridad

INSTRUCCIONES DE SEGURIDAD IMPORTANTES GUARDE ESTAS INSTRUCCIONES

Este manual contiene instrucciones importantes que debe seguir durante la instalación y el funcionamiento del EBM. Por favor, lea todas las instrucciones antes de poner en funcionamiento el equipo y guarde este manual para referencia en el futuro.

ADVERTENCIA



Este SIE contiene su propia fuente de energía (baterías). Los receptáculos de salida pueden transportar voltaje activo aun cuando el SIE no esté conectado con una fuente de CA.

PRECAUCIÓN



- Las baterías pueden constituir un riesgo de descarga eléctrica o quemaduras por corriente alta de corto circuito. Adopte las precauciones debidas. Personal calificado de servicio que conozca de baterías y esté al tanto de las precauciones requeridas debe darle servicio al equipo. Mantenga al personal no autorizado alejado de las baterías.
 - Es necesario desechar las baterías de un modo adecuado. Consulte las normas locales para conocer los requisitos pertinentes.
 - Nunca deseche las baterías en el fuego. Las baterías pueden explotar si se las expone a la llama.
-

Säkerhetsföreskrifter

VIKTIGA SÄKERHETSFÖRESKRIFTER SPARA DESSA FÖRESKRIFTER

Den här anvisningen innehåller viktiga instruktioner som du ska följa under installation och användning av EBM. Läs alla instruktioner innan du använder utrustningen och spara den här anvisningen för framtida referens.

VARNING



Den här UPS-enheten innehåller sin egen energikälla (batterier). Uttagen kan vara spänningsförande även då UPS-enheten inte är ansluten till spänningsnätet.

VIKTIGT



- Batterierna kan innebära en risk för elektrisk stöt eller brännskada från kortsluten starkström. Iakttag lämpliga försiktighetsåtgärder. Service ska utföras av utbildad servicepersonal med kunskap om batterierna och nödvändiga försiktighetsåtgärder. Håll ej behörig personal borta från batterierna.
 - Batterierna måste avyttras enligt anvisningarna i lokal lagstiftning.
 - Använda batterier får aldrig brännas upp. De kan explodera.
-

Chapter 2 Installation



NOTE *If you are installing the UPS and the Extended Battery Module for the first time, follow the installation instructions in the UPS user's guide.*

Inspecting the Equipment

If any equipment has been damaged during shipment, keep the shipping cartons and packing materials for the carrier or place of purchase and file a claim for shipping damage. If you discover damage after acceptance, file a claim for concealed damage.

To file a claim for shipping damage or concealed damage: 1) File with the carrier within 15 days of receipt of the equipment; 2) Send a copy of the damage claim within 15 days to your service representative.



NOTE *Check the battery recharge date on the shipping carton label. If the date has expired and the batteries were never recharged, do not use the UPS. Contact your service representative.*

EBM Installation

The Eaton 5125 UPS is a rack-mount UPS. After installing the rail kit and EBM mounting brackets, continue to “EBM Connections” on page 18.

The Eaton 9125 UPS can be installed in a rack or as a standalone cabinet. If you are installing the UPS in a rack, follow the instructions with the rail kit to set up the EBM. Otherwise, continue to the following section, “Eaton 9125 Tower Setup.”

Eaton 9125 EBM Tower Setup



NOTE If you are installing the UPS and the EBM for the first time, follow the installation instructions in the UPS user's guide.

The UPS and EBMs must be stabilized with joining brackets.

1. Carefully position the cabinets upright (see Figure 1).



NOTE The EBM must be installed to the right of the UPS as shown in Figure 1. Joining brackets are required for installations with two or more cabinets.

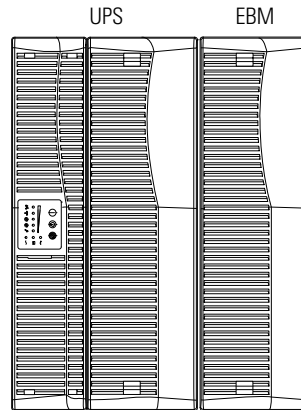

Figure 1. Eaton 9125 Tower UPS with an EBM

2. Align each joining bracket with the adjacent cabinet screw holes and secure with the supplied screws (see Figure 2).
3. If installing additional cabinets, repeat Step 2 for each cabinet.

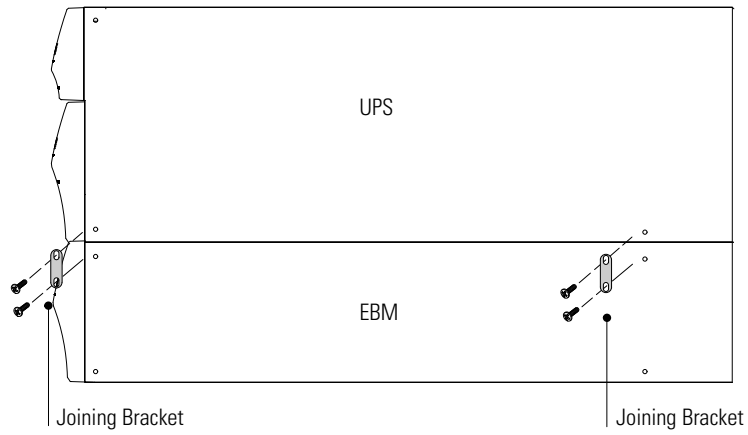

Figure 2. Installing the Joining Brackets (Top View)

4. Continue to the following section, "EBM Connections."

EBM Connections



NOTE *If you are installing the UPS and the EBM for the first time, follow the installation instructions in the UPS user's guide.*



CAUTION

A small amount of arcing may occur when connecting an EBM to the UPS. This is normal and will not harm personnel. Insert the EBM cable into the UPS battery connector quickly and firmly.

To connect the EBM(s):

1. Verify that all battery circuit breakers are in the OFF (O) position (see Figure 3 or Figure 4).
2. Plug the EBM cable of the first EBM into the UPS battery connector.

If additional EBMs are to be installed, plug the EBM cable of the second cabinet into the battery connector on the first EBM. Repeat for each additional EBM. Up to four EBMs may be connected to the UPS.



NOTE Eaton 5125 – *After UPS installation, ensure maximum battery runtime by configuring the UPS for the correct number of EBMs (see page 20).*

NOTE Eaton 9125 – *If you installed power management software and optional EBMs, ensure maximum battery runtime by using the Virtual Front Panel UPS utility on the Software Suite CD.*

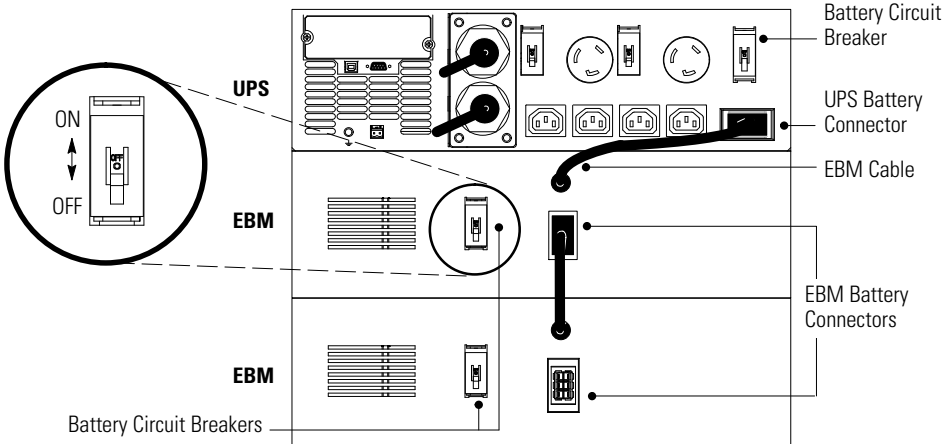

Figure 3. Typical Eaton 5125 EBM Installation

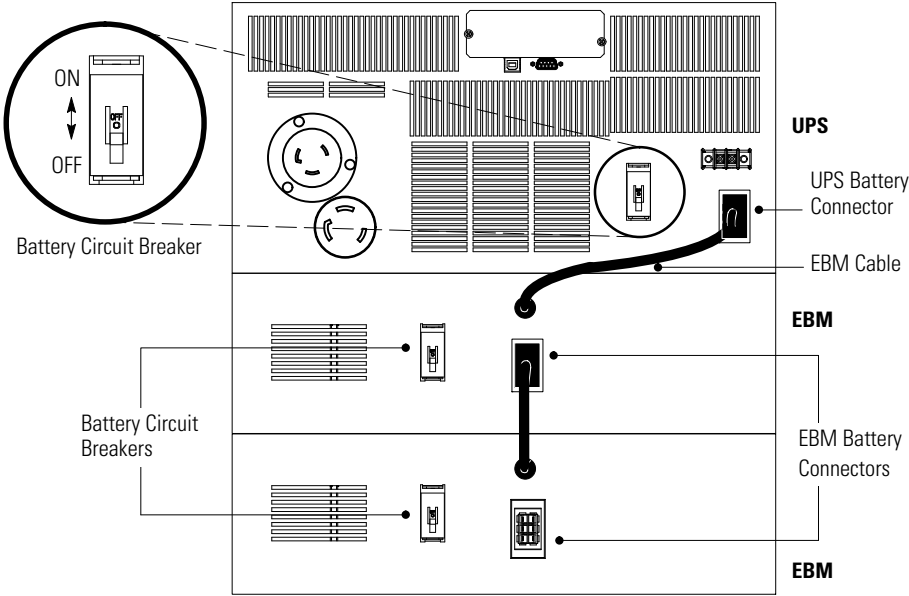





Figure 4. Typical Eaton 9125 EBM Installation

Eaton 5125 EBM Configuration

When the UPS is in Configuration mode, the front panel LEDs represent the configuration options. Use the control buttons (On | button, Off  button, and  button) to modify the UPS configuration. Figure 5 shows the LEDs and Table 3 on page 22 explains the corresponding EBM options.

To configure the UPS for EBMs:

1. Press and hold the On | button and the  button simultaneously for three seconds. The UPS transfers to Configuration mode.

The LEDs flash briefly and then display the enabled options.



NOTE If the LEDs start cycling automatically from left to right, repeat Step 1 and be sure to press both buttons.

2. Press the On | button to scroll through the options. Each time you press the button, the UPS beeps. The LED for the selected option indicates the current setting; flashing represents disabled options (see Figure 5 and Table 3 on page 22).



Scrolling past the last LED returns to the first configuration option.

If you press the On | button and nothing happens, the UPS is still in Operation mode. Repeat Step 1 to enter Configuration mode, and then perform Step 2.

3. Press the Off  button ONCE to select the number of EBMs.



NOTE The UPS exits Configuration mode automatically after two minutes of inactivity.

4. Press the  button to confirm the selection and exit Configuration mode. If you do not press the  button, the UPS defaults to the original settings.

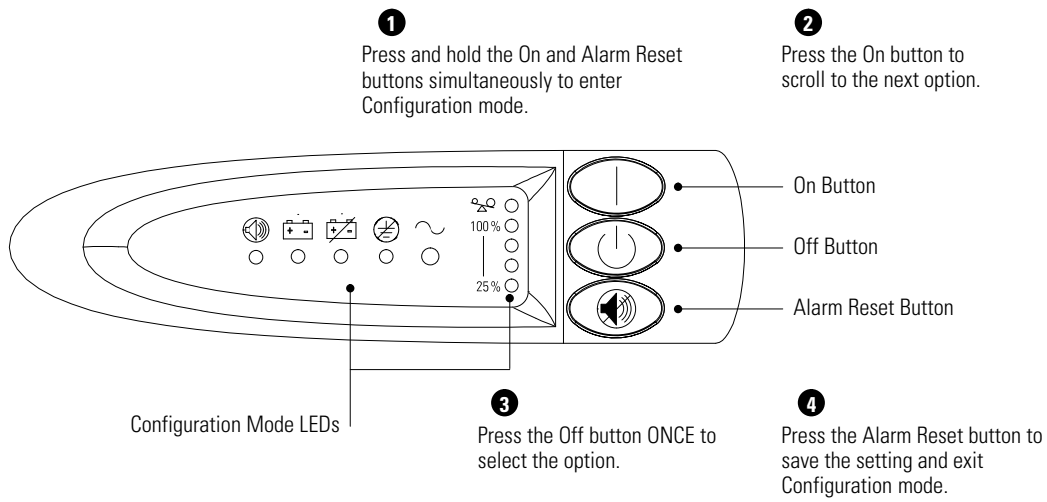
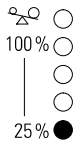
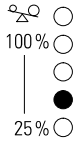
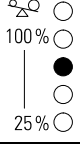
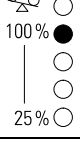
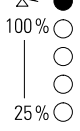

Figure 5. Using Configuration Mode (Eaton 5125)

Table 3. Eaton 5125 Configuration Mode LEDs and Options

Configuration Mode LEDs	Option	LED Status	Explanation
	0 EBMs	On	Zero EBMs are configured.
		Flashing	One of the other EBM configurations is selected.
	1 EBM	On	One EBM is configured.
		Flashing	One of the other EBM configurations is selected.
	2 EBMs	On	Two EBMs are configured.
		Flashing	One of the other EBM configurations is selected.
	3 EBMs	On	Three EBMs are configured.
		Flashing	One of the other EBM configurations is selected.
	4 EBMs	On	Four EBMs are configured.
		Flashing	One of the other EBM configurations is selected.

Chapter 3 EBM Maintenance

This section explains how to:

- Care for the UPS and batteries
- Replace the Extended Battery Modules (EBMs)
- Recycle used batteries or UPS

UPS and Battery Care

For the best preventive maintenance, keep the area around the UPS clean and dust-free. If the atmosphere is very dusty, clean the outside of the system with a vacuum cleaner.

For full battery life, keep the UPS at an ambient temperature of 25°C (77°F).



NOTE *The batteries in the UPS are rated for a 3–5 year service life. The length of service life varies, depending on the frequency of usage and ambient temperature. Batteries used beyond expected service life will often have severely reduced runtimes. Replace batteries at least every 5 years to keep units running at peak efficiency.*

Storing the EBM

If you store the EBM for a long period, recharge the battery every 10 months by connecting the UPS to utility power. The batteries charge to 80% capacity in approximately 3 hours. However, it is recommended that the batteries charge for 48 hours after long-term storage.

Check the battery recharge date on the shipping carton label. If the date has expired and the batteries were never recharged, do not use the UPS. Contact your service representative.

When to Replace Batteries

Eaton 5125 – When the  indicator flashes and the audible alarm beeps intermittently, the batteries may need replacing. Contact your service representative to order new batteries.

Eaton 9125 – When the  indicator flashes, the batteries may need replacing. Contact your service representative to order new batteries.

Replacing Batteries



NOTE *DO NOT DISCONNECT the batteries while the UPS is in Battery mode.*

With the hot-swappable battery feature, UPS batteries can be replaced easily without turning the UPS off or disconnecting the load.

If you prefer to remove input power to change the batteries, see “Turning the UPS Off” in the UPS user's guide.

Consider all warnings, cautions, and notes before replacing batteries.

WARNING



- Batteries can present a risk of electrical shock or burn from high short-circuit current. The following precautions should be observed: 1) Remove watches, rings, or other metal objects; 2) Use tools with insulated handles; 3) Do not lay tools or metal parts on top of batteries.
 - **ELECTRIC ENERGY HAZARD.** Do not attempt to alter any battery wiring or connectors. Attempting to alter wiring can cause injury.
-

How to Replace Eaton 5125 EBM

CAUTION



The EBM is heavy (69.9 kg/154 lb). A minimum of two people are required to lift the EBM when it is replaced.

To replace the Eaton 5125 EBM(s):

1. Switch all battery circuit breakers to the OFF position (see Figure 6).
2. Unplug the EBM cable from the UPS.

If additional EBMs are installed, unplug the EBM cable from the battery connector on each EBM.
3. Install the supplied mounting brackets on the new EBM.
4. Replace the EBM. See “Recycling the Used Battery or UPS” on page 28 for proper disposal.

5. Plug the EBM cable into the UPS as shown in Figure 6.
 For additional EBMs, plug the EBM cable into the battery connector on the adjacent EBM.
6. Remove the breaker tie from the circuit breaker on all EBMs.
7. Switch all battery circuit breakers to the ON position.

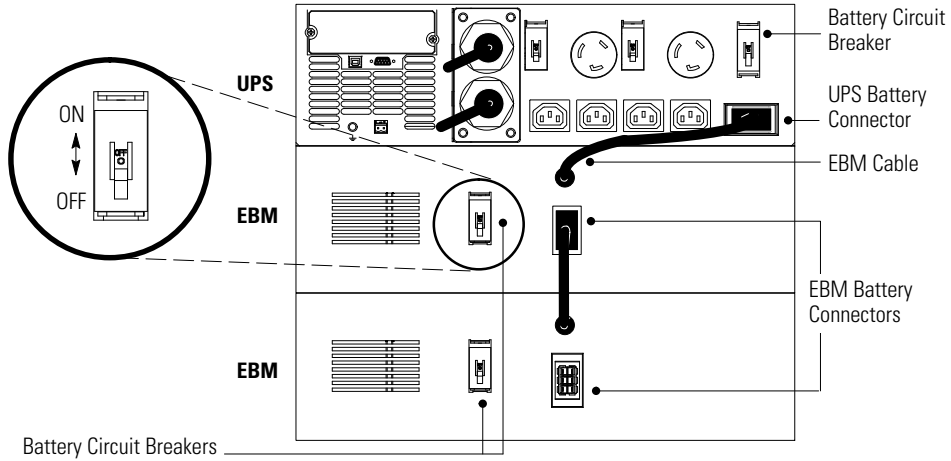

Figure 6. Eaton 5125 EBM Connections

How to Replace Eaton 9125 EBM

CAUTION



The EBM is heavy (69.9 kg/154 lb). A minimum of two people are required to lift the EBM when it is replaced.

To replace the Eaton 9125 EBM(s):

1. Switch all battery circuit breakers to the OFF (O) position (see Figure 7).
2. Unplug the EBM cable from the UPS.

If additional EBMs are installed, unplug the EBM cable from the battery connector on each EBM.
3. If the UPS is in a tower configuration, remove the joining brackets.
4. If the UPS is in a rack, attach the supplied mounting brackets to the new EBM.
5. Replace the EBM. See “Recycling the Used Battery or UPS” on page 28 for proper disposal.
6. Reinstall the joining brackets if removed in Step 3.
7. Plug the new EBM into the UPS as shown in Figure 7.

For additional EBMs, plug the EBM cable into the battery connector on the adjacent EBM.
8. Remove the breaker tie from the circuit breaker on all EBMs.
9. Switch all battery circuit breakers to the ON (|) position.

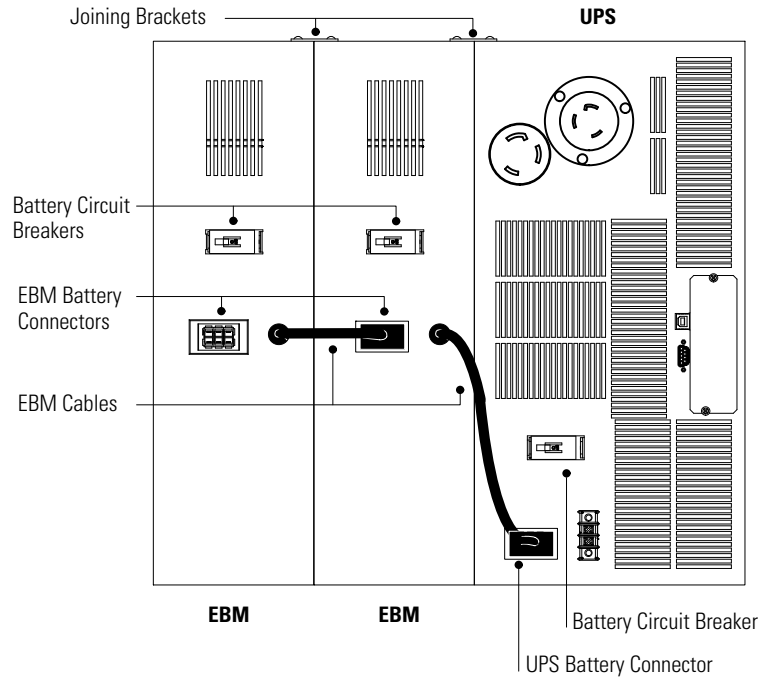

Figure 7. Eaton 9125 EBM Connections

Recycling the Used Battery or UPS

Contact your local recycling or hazardous waste center for information on proper disposal of the used battery or UPS.



WARNING

- Do not dispose of the battery or batteries in a fire. Batteries may explode. Proper disposal of batteries is required. Refer to your local codes for disposal requirements.
- Do not open or mutilate the battery or batteries. Released electrolyte is harmful to the skin and eyes. It may be toxic.



CAUTION

Do not discard the UPS or the UPS batteries in the trash. This product contains sealed, lead-acid batteries and must be disposed of properly. For more information, contact your local recycling/reuse or hazardous waste center.



CAUTION

Do not discard waste electrical or electronic equipment (WEEE) in the trash. For proper disposal, contact your local recycling/reuse or hazardous waste center.

Chapter 4 Service and Support

If you have any questions or problems with the UPS, call your **Local Distributor** or the **Help Desk** at one of the following telephone numbers and ask for a UPS technical representative.

United States: **1-800-356-5737**
Canada: **1-800-461-9166 ext 260**
All other countries: **Call your local service representative**

Please have the following information ready when you call the Help Desk:

- Model number
- Serial number
- Version number (if available)
- Date of failure or problem
- Symptoms of failure or problem
- Customer return address and contact information

If repair is required, you will be given a Returned Material Authorization (RMA) Number. This number must appear on the outside of the package and on the Bill Of Lading (if applicable). Use the original packaging or request packaging from the Help Desk or distributor. Units damaged in shipment as a result of improper packaging are not covered under warranty. A replacement or repair unit will be shipped, freight prepaid for all warrantied units.



NOTE *For critical applications, immediate replacement may be available. Call the **Help Desk** for the dealer or distributor nearest you.*
